

**SIR JOHN A. MACDONALD
RIVERFRONT LINEAR PARK**

LANDSCAPE PLANS - SOUTH OF SJAM (12/03/18)

KEY PLAN / PLAN DE LOCALISATION

PAGE	TITLE / TITRE
LA-01	LANDSCAPE PLANS SOUTH OF SJAM - ZONE 1
LA-02	LANDSCAPE PLANS SOUTH OF SJAM - ZONE 2
LA-03	LANDSCAPE PLANS SOUTH OF SJAM - ZONE 3
LA-04	LANDSCAPE PLANS SOUTH OF SJAM - ZONE 4
LA-05	LANDSCAPE PLANS SOUTH OF SJAM - ZONE 5
LA-06	LANDSCAPE PLANS SOUTH OF SJAM - ZONE 6
LA-07	LANDSCAPE PLANS SOUTH OF SJAM - ZONE 7
LA-08	LANDSCAPE PLANS SOUTH OF SJAM - ZONE 8
LA-09	(NOT IN CONTRACT) LANDSCAPE PLANS SOUTH OF SJAM - ATLANTIS PARKING LOT PLANTING PLAN
LA-10	LANDSCAPE PLANS SOUTH OF SJAM - DETAILS 1
LA-11	LANDSCAPE PLANS SOUTH OF SJAM - DETAILS 2
LA-12	LANDSCAPE PLANS SOUTH OF SJAM - DETAILS 3 - TYPICAL AT GRADE CROSSING

PLANT LIST - LA-02

SYM.	BOTANICAL NAME	COMMON NAME	QTY.	SIZE	REMARKS
DECIDUOUS TREE					
BA2	Betula cespitosa var. pendula	Yellow Birch	4	Clump 50cm WB	4m O/C
PT2	Populus tremuloides	Trembling aspen	10	3m HT	4m O/C
PB	Populus balsamifera	Balsam poplar	1	1.5m HT	4m O/C
CONIFEROUS TREE					
PA2	Picea Abies	Norway Spruce	3	2.5m HT.	4m O/C
PB2	Pinus Banksiana	Jack Pine	10	2m HT.	4m O/C
PK3	Pinus Banksiana	Jack Pine	2	2.5m HT.	4m O/C
PL	Picea Glauca	White Spruce	1	2m HT.	4m O/C
PP1	Picea Fungaria Engelm.	Green Colorado Spruce	3	1.5m HT	4m O/C
PP2	Picea Fungaria Engelm.	Green Colorado Spruce	5	2m HT	4m O/C
PP3	Picea Fungaria Engelm.	Green Colorado Spruce	9	2.5m HT	4m O/C
PR2	Pinus resinosa	Red Pine	4	2m HT.	4m O/C
FR3	Pinus resinosa	Red Pine	3	2.5m HT.	4m O/C

SPECIES	Common name	% of Mix
INDIGO SEED MIX (TYPE 2 - WARM)		
Deciduous		
Aster spicatus	butterfly weed	10%
Chamaenerion sp.	Yellow Carduus	7%
Rudbeckia sp.	Black seed heads	8%
Coreopsis verticillata	Lanceleaf Coreopsis	15%
Solidago canadensis	Canada goldenrod	8%
Phacelia sp.	Blue Phacelia	10%
Rudbeckia hirta	Brown-eyed Susan	5%
Thalictrum flavum	Tall Meadow Rue	8%
Achillea millefolium	Yarrow	8%
sub total 65%		
Grasses		
Lolium perenne	Perennial Ryegrass	7%
Dactylis glomerata	Indigo grass	4%
Deschampsia cespitosa	Tufted hairgrass	3%
Sporobolus vaginifolius	Perennial Dropseed	4%
Deschampsia flexuosa	Wavy hairgrass	1%
Calamagrostis canadensis	Bluegrass	7%
Lolium multiflorum	Annual Ryegrass	8%
sub total 45%		
Total 110%		

GENERAL NOTE:
 • EXISTING SOUTH ASPHALT PATHWAY AND GRANULAR BASE REMOVAL IS INCLUDED IN THIS CONTRACT
 • REFER TO SEED SPECIFICATION FOR BED PREPARATION
 • PROTECT EXISTING TREES AND ROOTS THROUGHOUT CONSTRUCTION

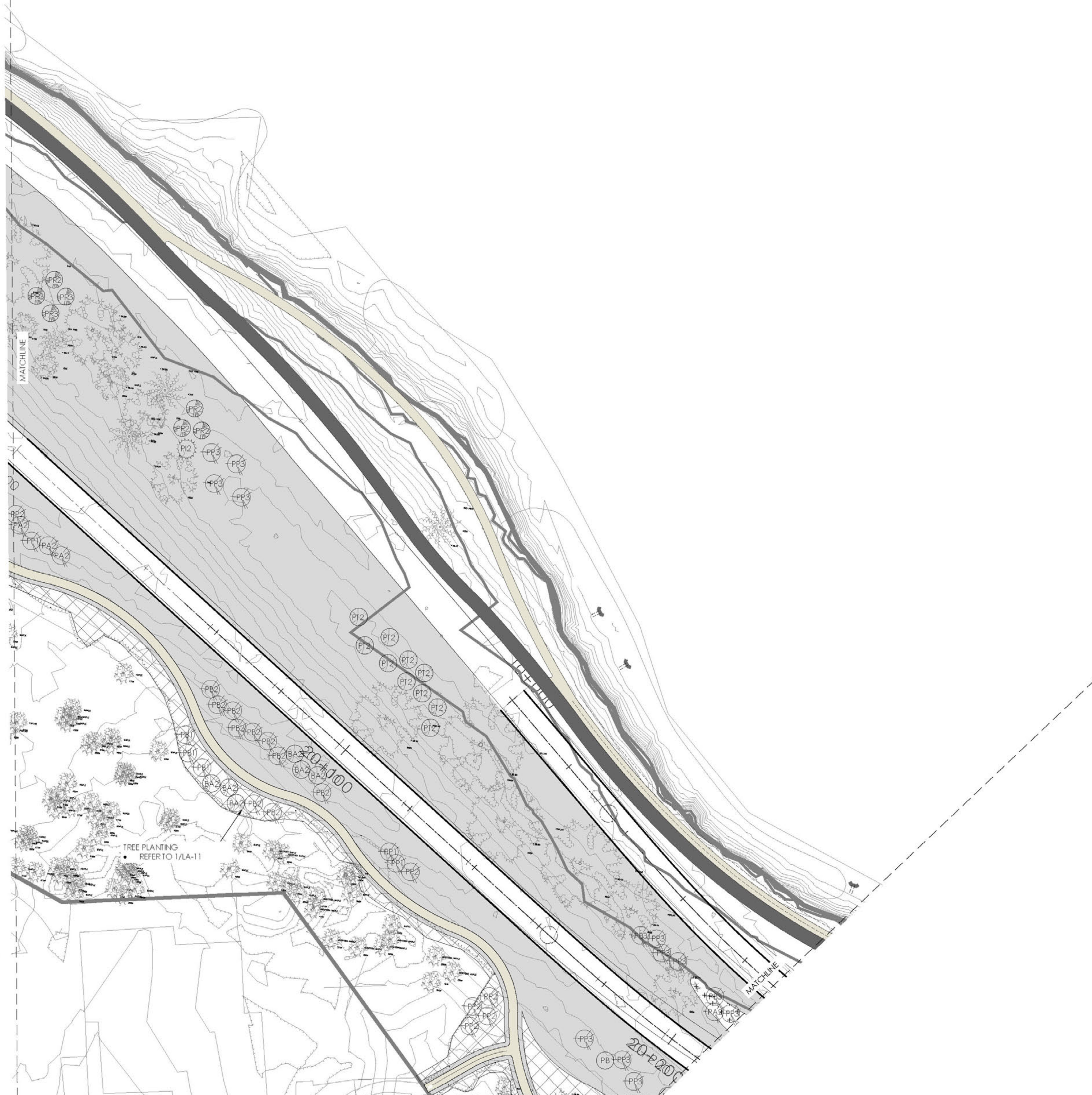

- Grading of proposed path shall match grades of existing path except where agreed upon LRT and parkway realignment/regrading requires the path grades to change, with approval of NCC. The Commission requires that contour grading along the pathway be established to respect UA requirements.
- All damages areas to be reinstated by contractor
- Underground locates to be completed prior to any excavation
- NCC to provide seeding bed layout and pathway coordinates once city has confirmed parkway alignment.
- South trail offset plant materials 2.5m from centreline

LEGEND

- LOW MAINTENANCE LAWN: 'INDIGO GRASSES' SEED PLANTING WITH 'INDIGO GRASSES' ALONG 2M OFFSET OF ALL PARKWAY EDGES
- 65% 'INDIGO-ULTRA POLINISATION' MIXED WITH 35% 'INDIGO-PLANTES MELLIFÈRES'
- CUSTOM SEED MIX (TYPE 1 - COOL)
- CUSTOM SEED MIX (TYPE 2 - WARM)
- EXISTING TREES
- PROPOSED CONIFEROUS TREE
- PROPOSED DECIDUOUS TREE

issued or revised / émis ou révisé

no.	description	date
5	RESUBMIT REVISED SJAM	12/03/18
4	REVISION 3	22/02/18
3	REVISION 2	05/05/17
2	REVISION 1	12/04/17
1	100% DESIGN DEVELOPMENT	06/02/17

project / projet

SIR JOHN A. MACDONALD RIVERFRONT LINEAR PARK / PARC LINÉAIRE RIVERAIN SIR-JOHN-A-MACDONALD

drawing / dessin

LANDSCAPE PLANS SOUTH OF SJAM - ZONE 2

approved by / approuvé par: S.FISHER
 designed by / conçu par: S.FISHER/S.DEGUIRE
 drawn by / dessiné par: S.DEGUIRE
 date: 13/09/16 scale / échelle: 1:500
 NCC project no. / no. du projet de la CCN: DC 5205-16 sheet no. / no. de la feuille: LA-02

National Capital Commission - Commission de la capitale nationale
 sheet size: ISO_A1

PLANT LIST - LA-08

SYM.	BOTANICAL NAME	COMMON NAME	QTY.	SEE	REMARKS
DECIDUOUS TREE					
PT2	Populus tremuloides	Trembling aspen	2	3m HT	4m O/C
QP	Quercus pallustris	Pin oak	8	2m HT	4m O/C
TA	Tilia americana 'Valley Forge'	Basswood	2	2.5m HT	4m O/C
UA	Ulmus americana 'Valley Forge'	Valley Forge white elm	5	2m HT	4m O/C
CONIFEROUS TREE					
AB1	Abies balsamea	Balsam Fir	0	1.5m HT	4m O/C
AB2	Abies balsamea	Balsam Fir	0	2m HT	4m O/C
PR2	Pinus banksiana	Jack Pine	15	2m HT	4m O/C
PR3	Pinus banksiana	Jack Pine	0	2.5m HT	4m O/C
PI2	Picea glauca	White Spruce	0	2m HT	4m O/C
PI3	Picea glauca	White Spruce	0	3m HT	4m O/C
TC2	Thuja occidentalis	Eastern White Cedar	2	2.5m HT	4m O/C

Species	Common name	% of Mix
Deciduous		
Ulmus americana	Valley Forge Elm	2%
Quercus pallustris	Pin Oak	8%
Pinus banksiana	Jack Pine	15%
Tilia americana	Basswood	2%
Ulmus americana	Valley Forge Elm	7%
Ulmus americana	Valley Forge Elm	12%
Ulmus americana	Valley Forge Elm	7%
Ulmus americana	Valley Forge Elm	8%
Ulmus americana	Valley Forge Elm	8%
Ulmus americana	Valley Forge Elm	2%
Ulmus americana	Valley Forge Elm	8%
Ulmus americana	Valley Forge Elm	4%
Ulmus americana	Valley Forge Elm	10%
Grasses		
Schizanthus liliifolium	Valley Forge Elm	2%
Ulmus americana	Valley Forge Elm	4%
Ulmus americana	Valley Forge Elm	4%
Ulmus americana	Valley Forge Elm	4%
Ulmus americana	Valley Forge Elm	8%
Ulmus americana	Valley Forge Elm	8%
Ulmus americana	Valley Forge Elm	2%



Real Estate Management, Design and Construction Branch
Direction de la gestion de l'immobilier, design et construction

Design and Construction Division
Division design et construction
director - Claude Robert - directeur

- Grading of proposed path shall match grades of existing path except where agreed upon LRT and parkway realignment/grading requires the path grades to change, with approval of NCC. The Commission requires that contour grading along the pathway be established to respect UA requirements.
- All damages areas to be reinstated by contractor
- Underground locates to be completed prior to any excavation
- NCC to provide seeding bed layout and pathway coordinates once city has confirmed parkway alignment.
- South trail offset plant materials 2.5m from centreline

LEGEND

- LOW MAINTENANCE LAWN: 'INDIGO GRAMINIS' SEED PLANTING WITH 'INDIGO GRAMISEL' ALONG 2M OFFSET OF ALL PARKWAY EDGES
- 65% 'INDIGO-ULTRA POLINISATION' MIXED WITH 35% 'INDIGO-PLANTES MELLIFÈRES'
- CUSTOM SEED MIX (TYPE 1 - COOL)
- CUSTOM SEED MIX (TYPE 2 - WARM)
- EXISTING TREES
- PROPOSED CONIFEROUS TREE
- PROPOSED DECIDUOUS TREE

Issued or revised	émis ou révisé	
5	RESUBMIT REVISED SJAM	12/03/18
4	REVISION 3	22/02/18
3	REVISION 2	05/05/17
2	REVISION 1	12/04/17
1	100% DESIGN DEVELOPMENT	06/02/17
no.	description	date

project
projet

SIR JOHN A. MACDONALD
RIVERFRONT LINEAR PARK /
PARC LINÉAIRE RIVERAIN
SIR-JOHN-A-MACDONALD

drawing
dessin

LANDSCAPE PLANS
SOUTH OF SJAM - ZONE 8

approved by
approuvé par S.FISHER

designed by
conçu par S.FISHER/S.DEGUIRE

drawn by
dessiné par S.DEGUIRE

date 13/09/16 scale 1:500
échelle

NCC project no. sheet no.
no. du projet de la CCN no. de la feuille

DC 5205-16 LA-08

W:\DC5205\projets\5205-01 SJAM Landscape Design\5205-01 SJAM Landscape Design - Landscape Plan - Landscape Plan - 2018.03.14.dwg
 Modifié: 14. 03.2018 2:28:59 PM

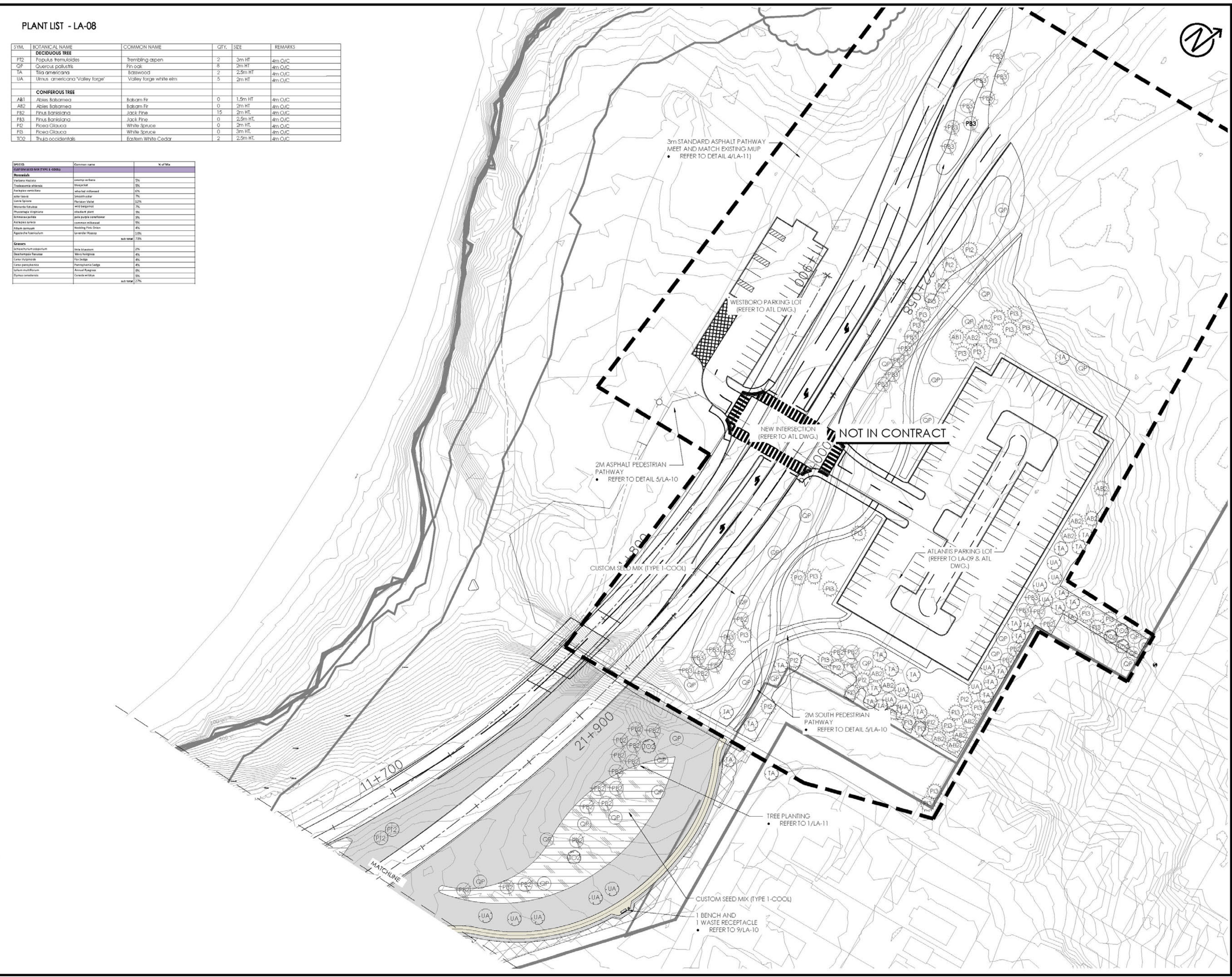

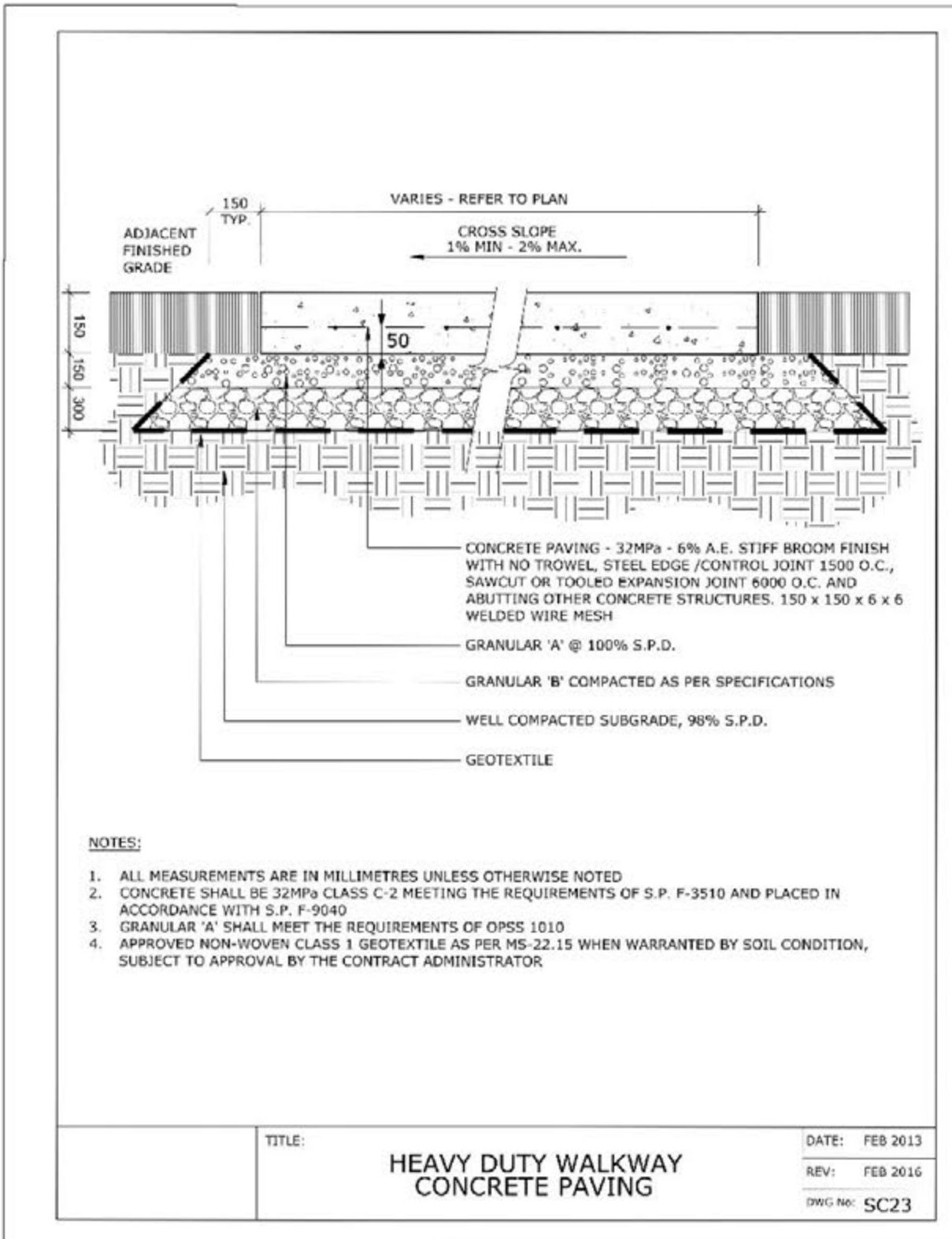

1 HEAVY DUTY WALKWAY CONCRETE PAVING
LA-10 (CLEARY FAN PLANT)

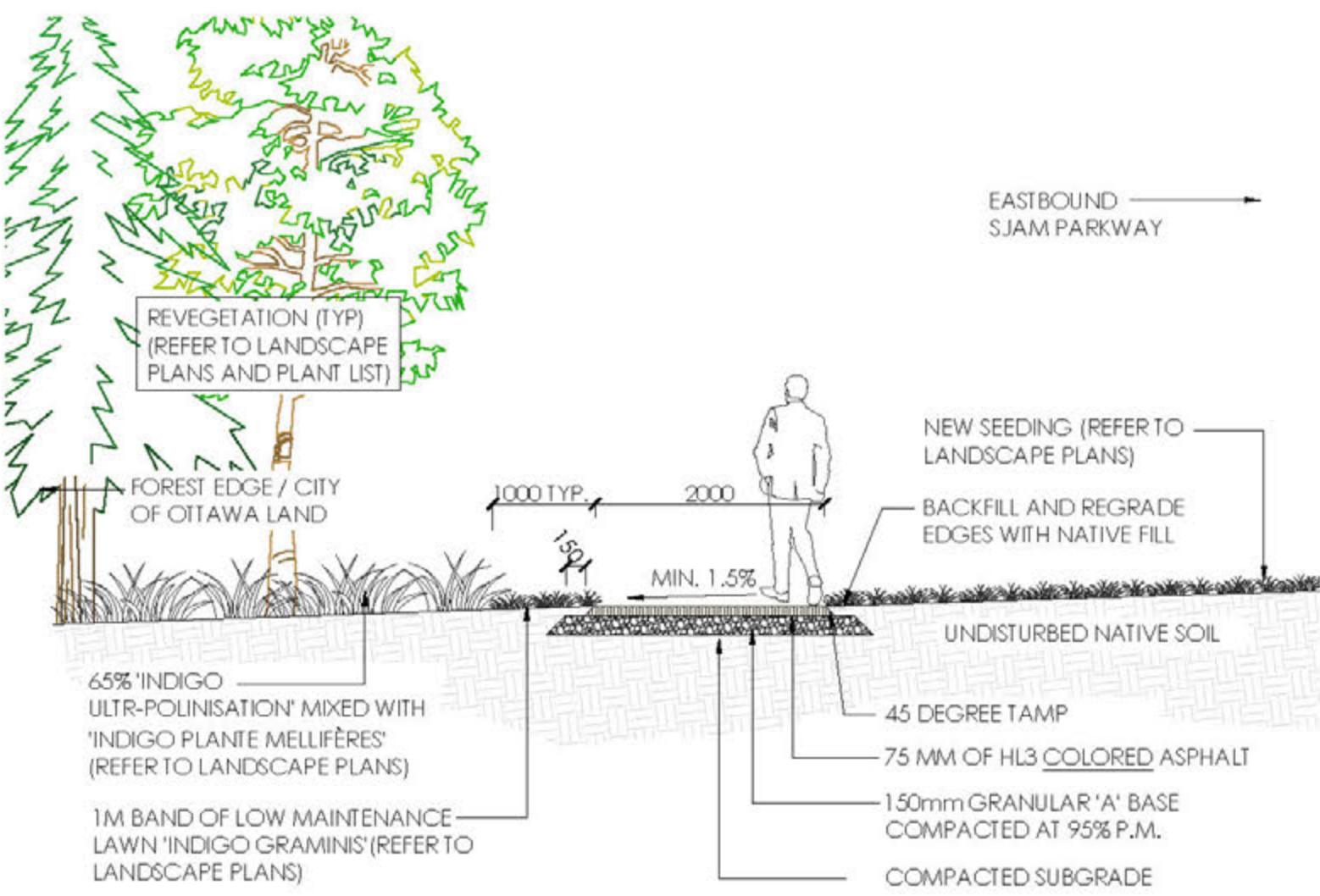

NOTE:
• ALWAYS ENSURE POSITIVE DRAINAGE FOR SOUTHERN PATHWAY
• ENSURE CROSS SLOPE FROM PARKWAY TO FOREST EDGE WHEN POSSIBLE
• NO CENTERLINE ON THIS PATHWAY
• PEDESTRIAN SYMBOLS AT EACH ENTRANCE TO BE PAINTED IN WHITE (REFER TO PLAN)

5 2M SOUTH PEDESTRIAN PATHWAY
LA-10

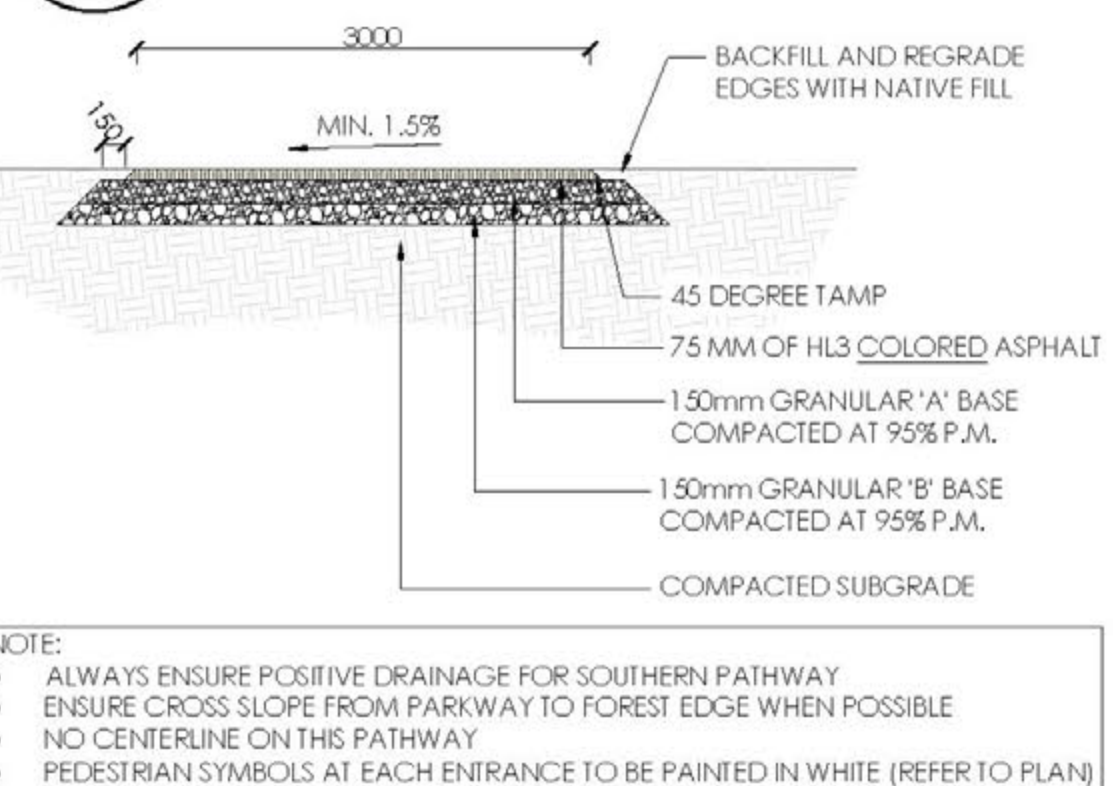

8 3M SOUTH PEDESTRIAN PATHWAY
LA-10 (CLEARY AREA)

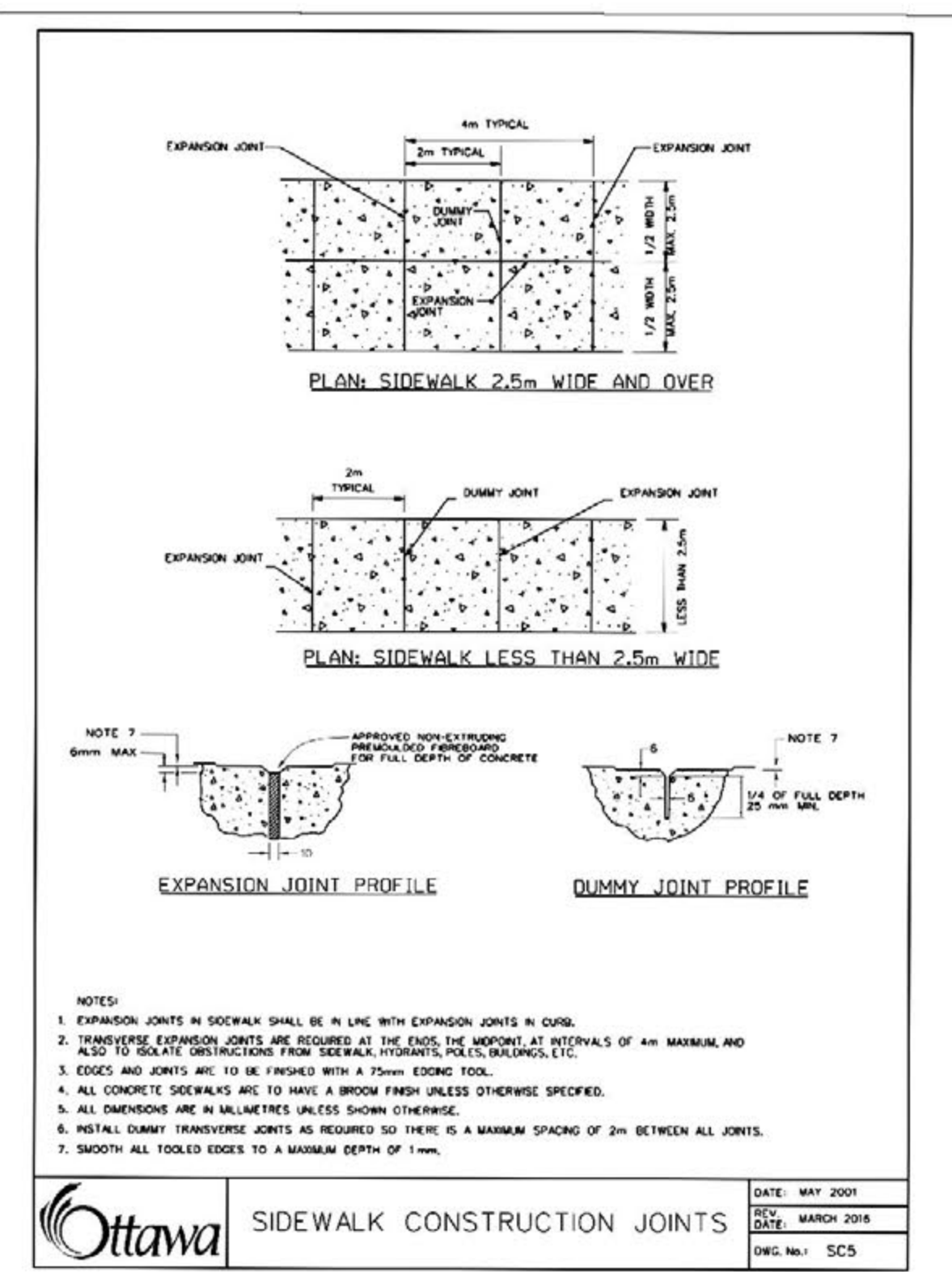

2 SIDEWALK CONSTRUCTION JOINTS
LA-10 (CLEARY FAN PLANT)

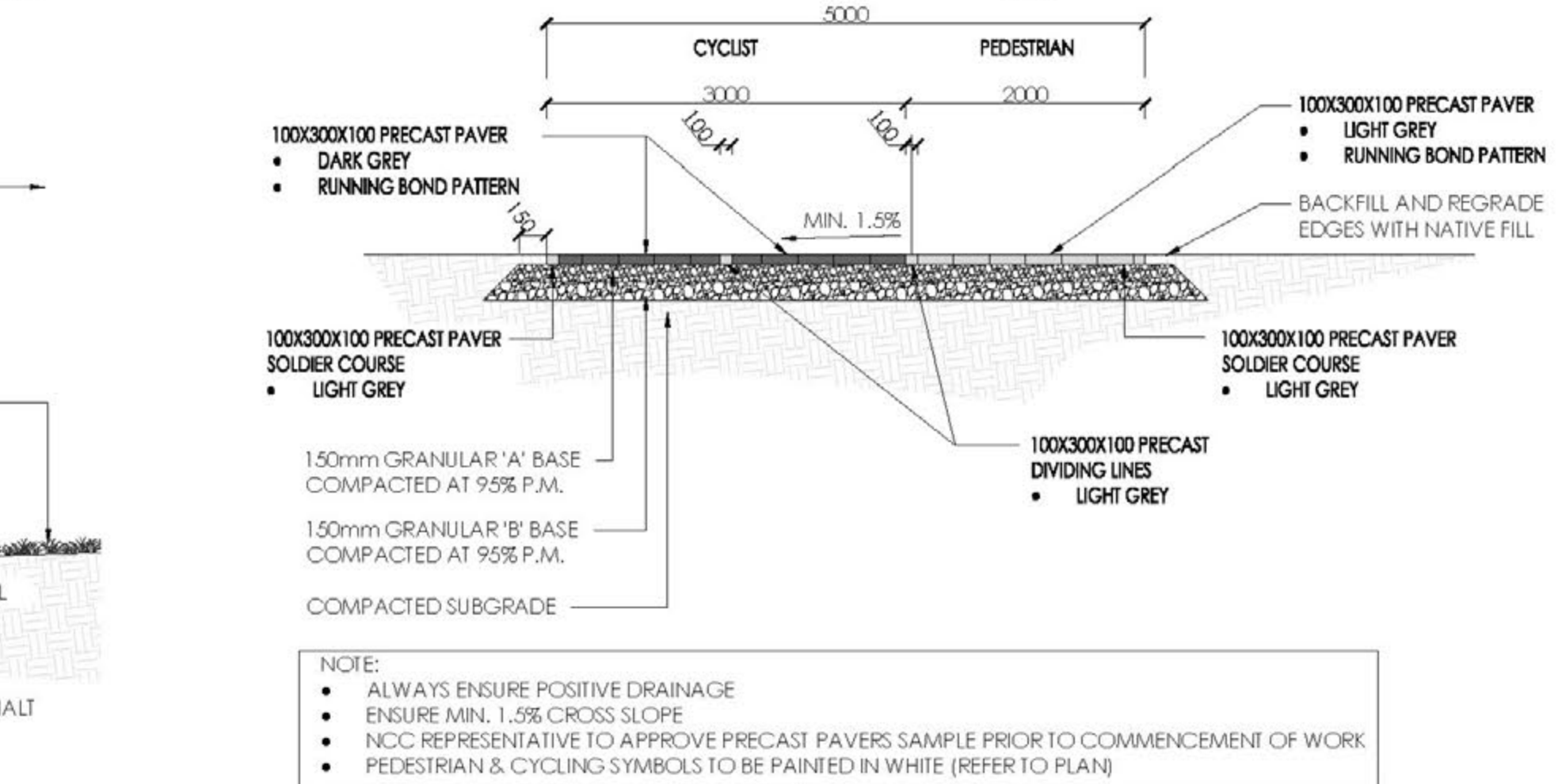

6 PRECAST PAVERS (DOMINION STATION CROSSING)
LA-10

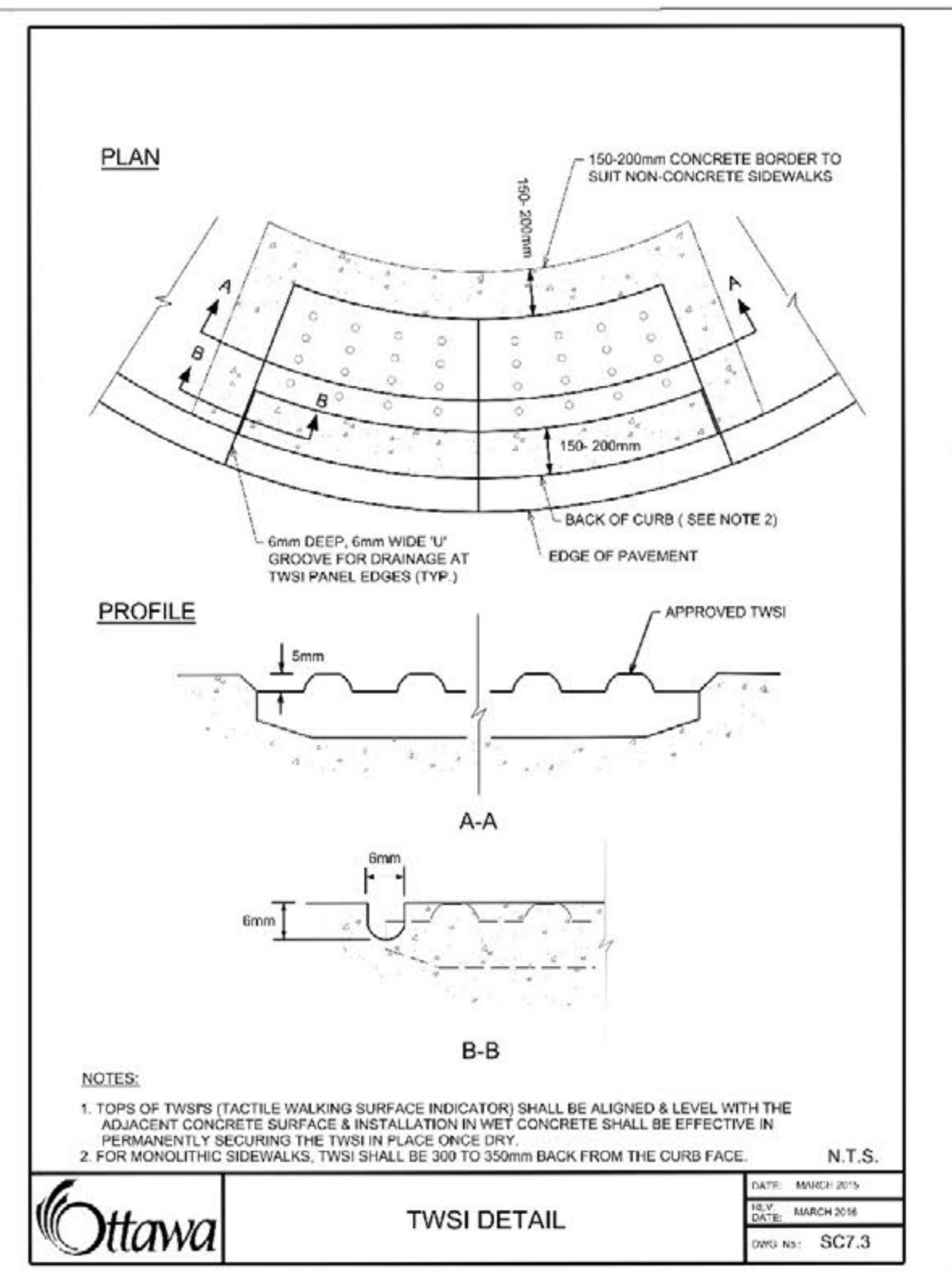

3 TWISI DETAIL
LA-10

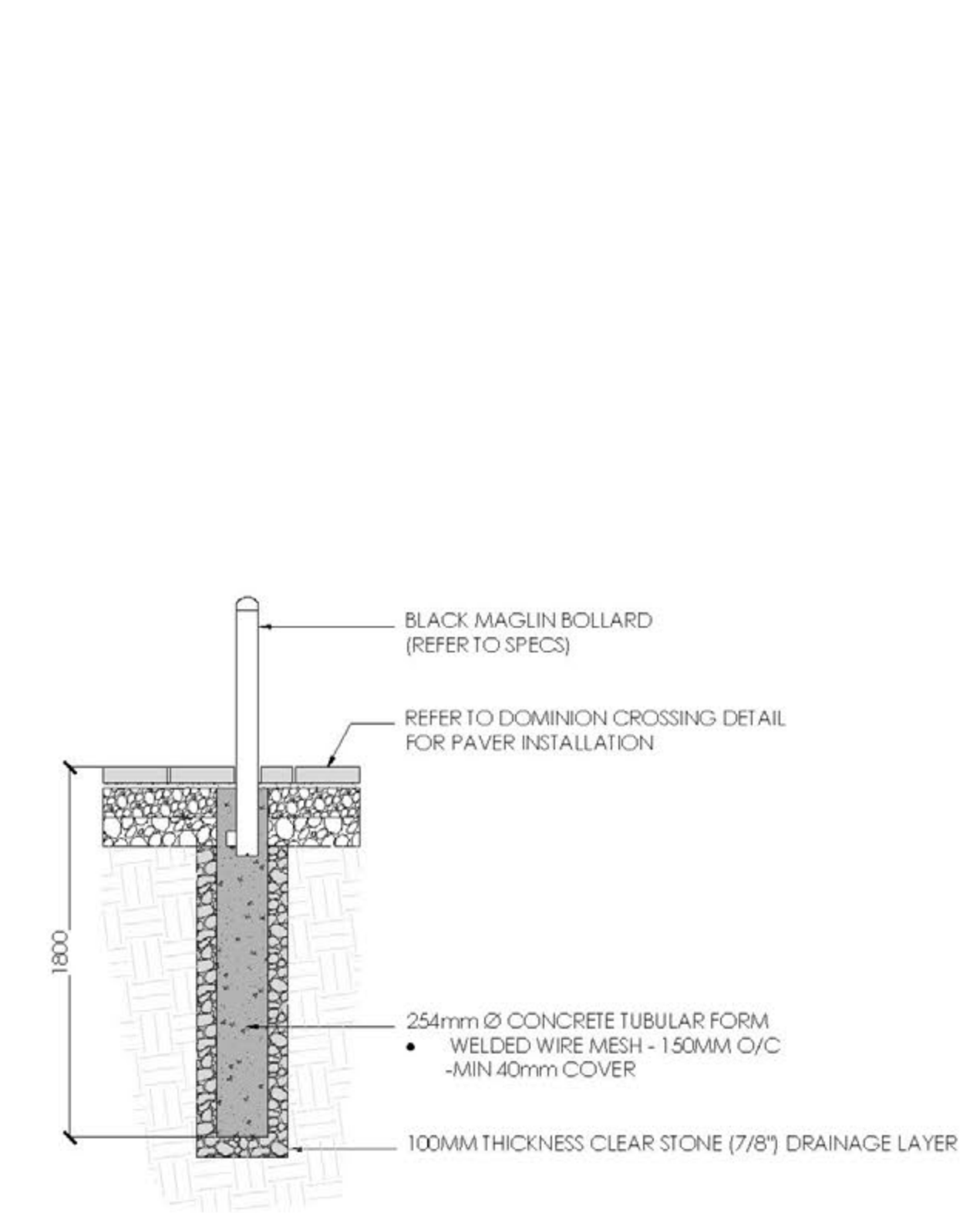

4 BLACK METAL BOLLARD
LA-10

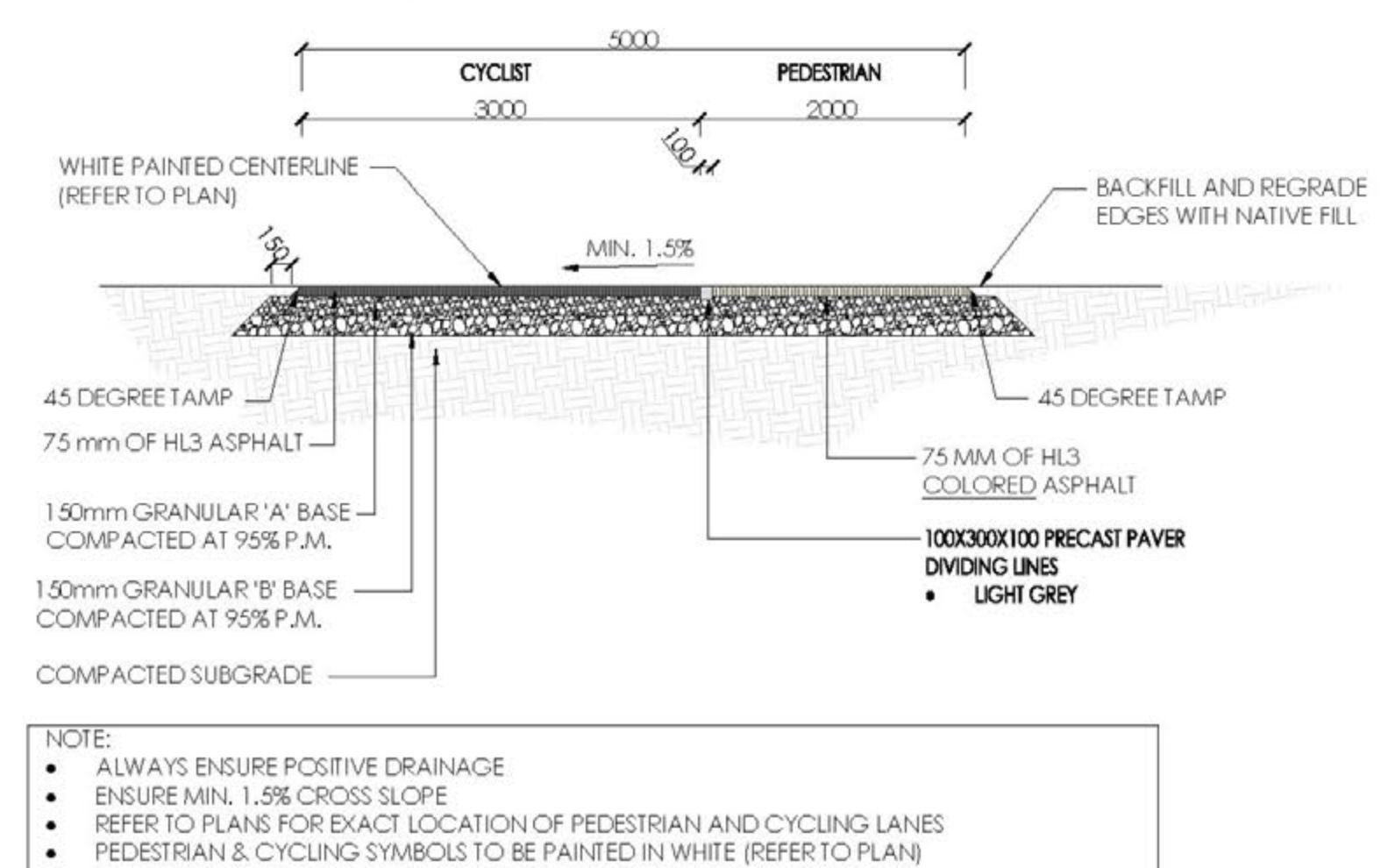

7 5M SEGREGATED PATHWAY
LA-10

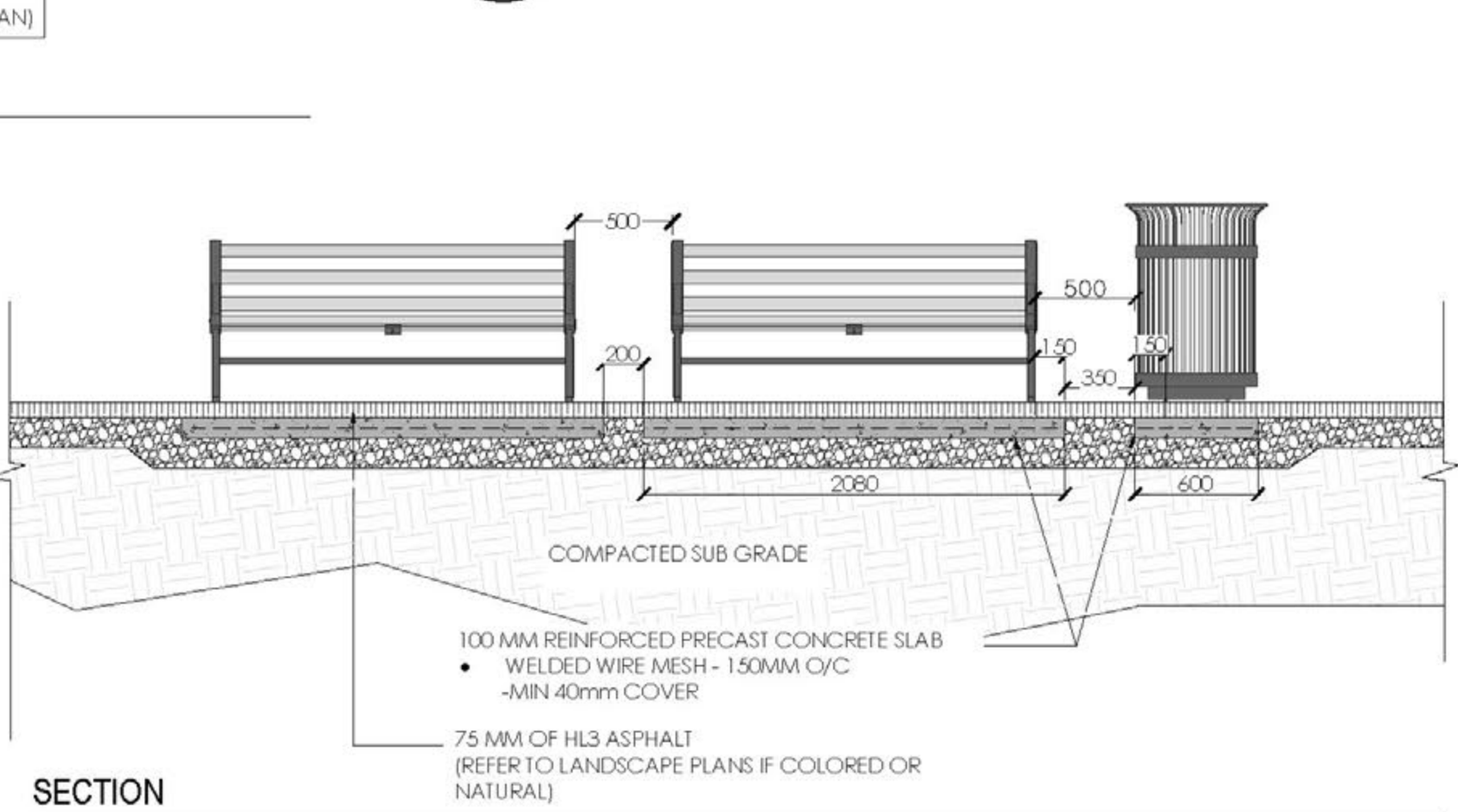

9 SITE FURNITURE INSTALLATION
LA-10

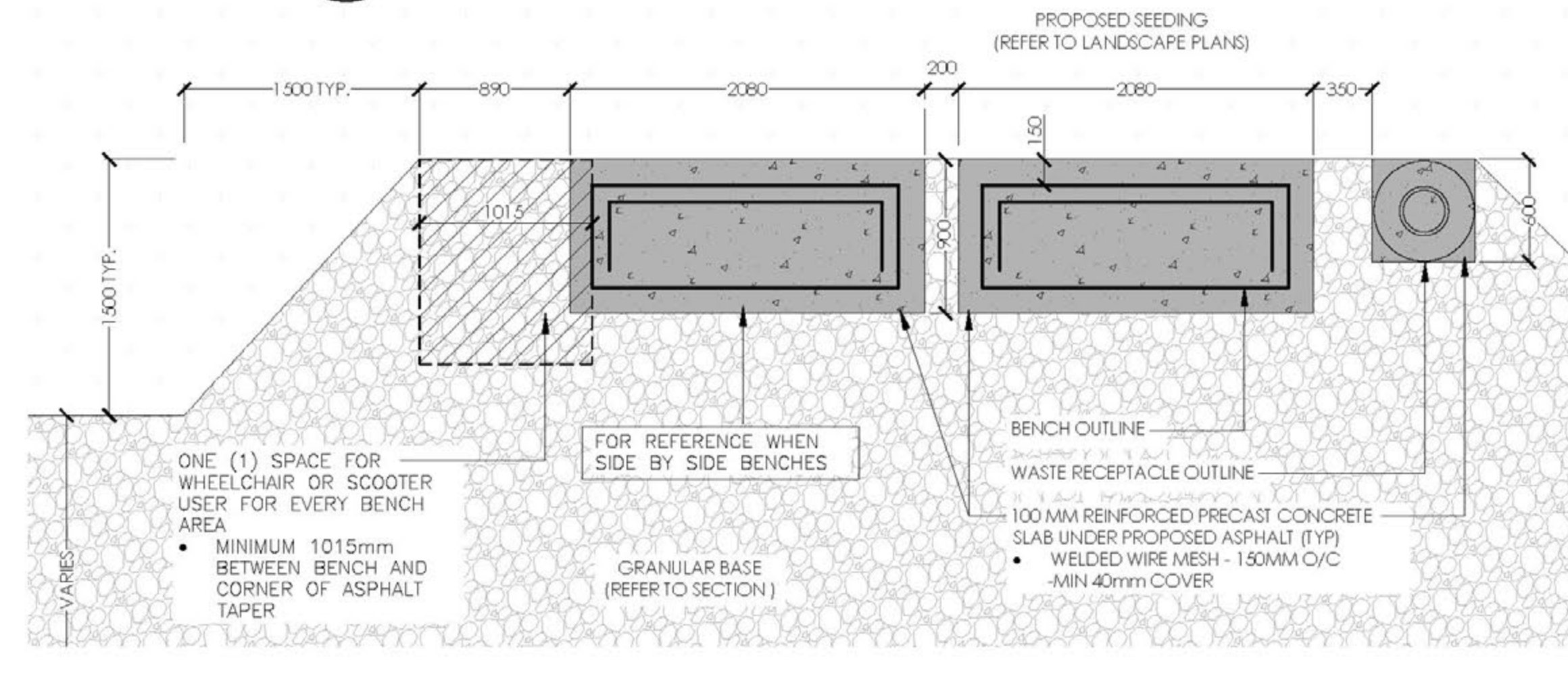

PLAN VIEW (CONCRETE PAD LAYOUT ONLY)

no.	description	date
4	REVISION 3	22/02/18
3	REVISION 2	05/05/17
2	REVISION 1	12/04/17
1	100% DESIGN DEVELOPMENT	06/02/17

SIR JOHN A. MACDONALD RIVERFRONT LINEAR PARK / PARC LINÉAIRE RIVERAIN SIR-JOHN-A-MACDONALD

drawing dessin

LANDSCAPE DETAILS 1 SOUTH OF SJAM

approved par S.FISHER
designed by S.FISHER/S.DEGUIRE
drawn by S.DEGUIRE

date 13/09/16 scale AS NOTED
sheet no. NCC project no. DC 5205-16
no. du projet de la CCN no. de la feuille LA-10

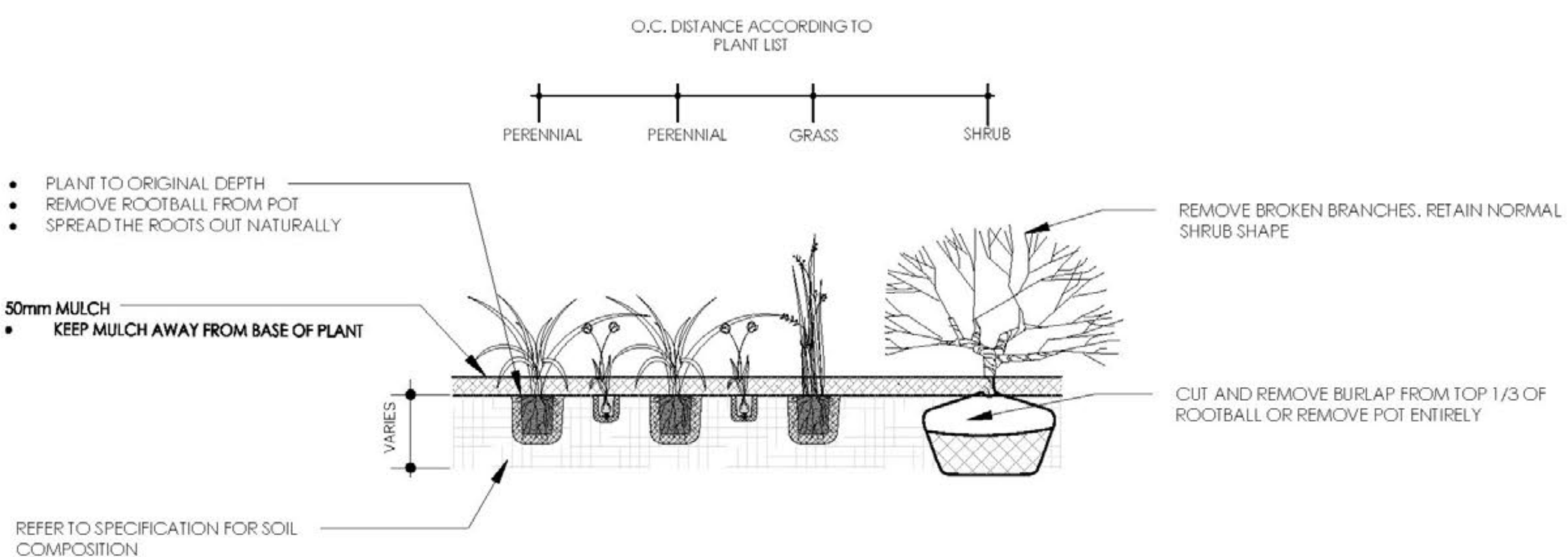
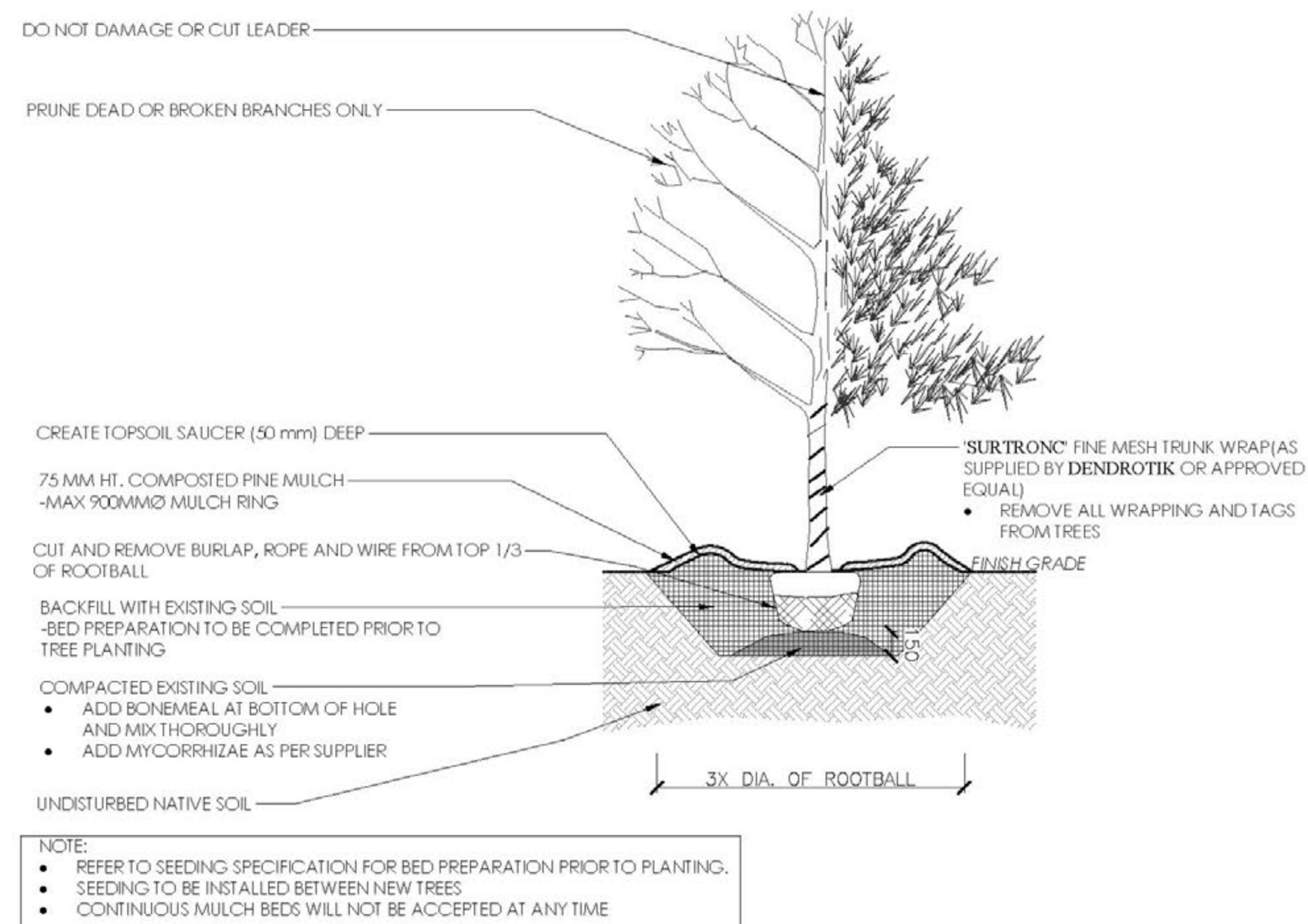

1 TREE PLANTING
LA-11

2 SHRUB, PERENNIAL AND GRASS PLANTING
LA-11

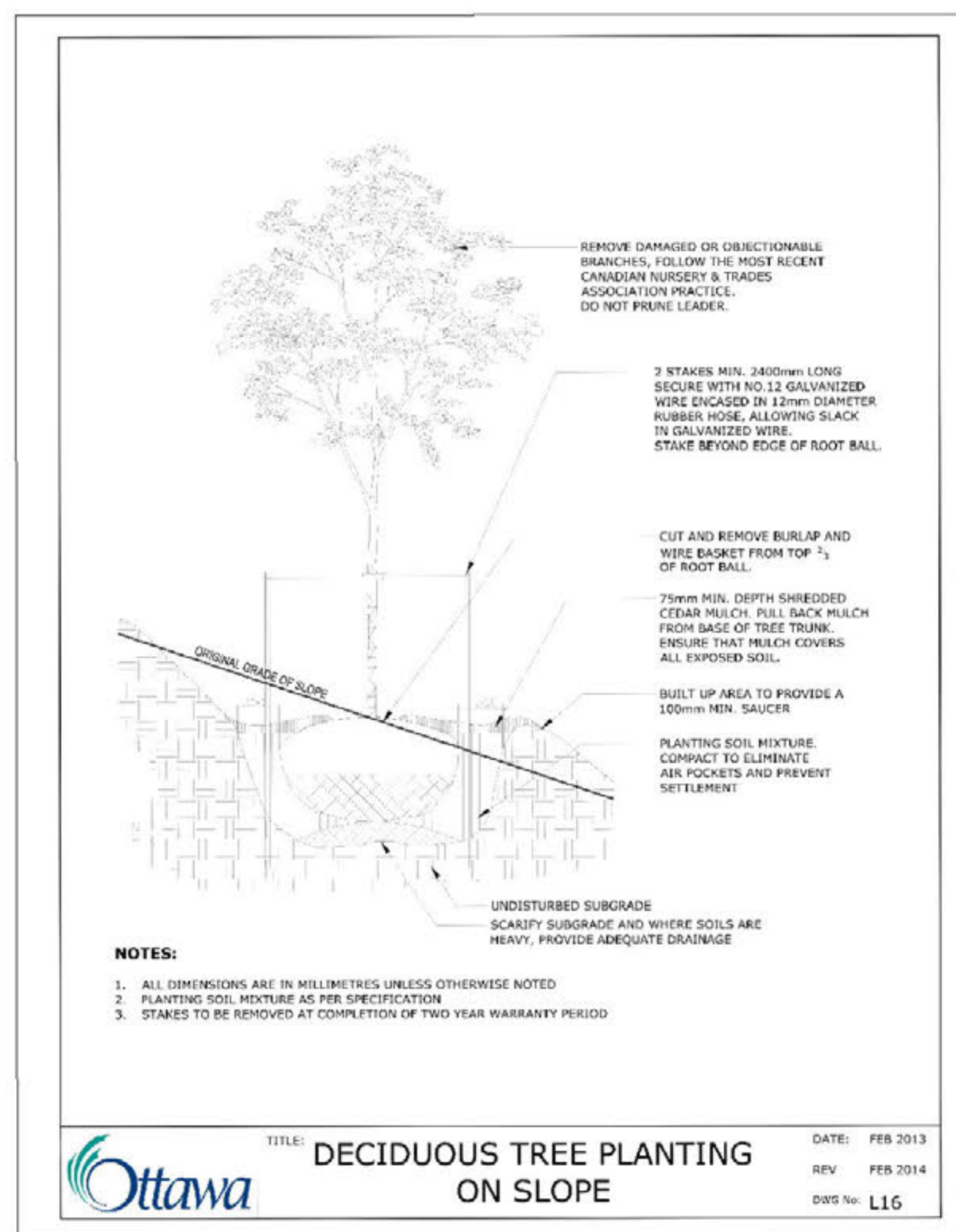

3 DECIDUOUS TREE PLANTING IN SLOPE
LA-11

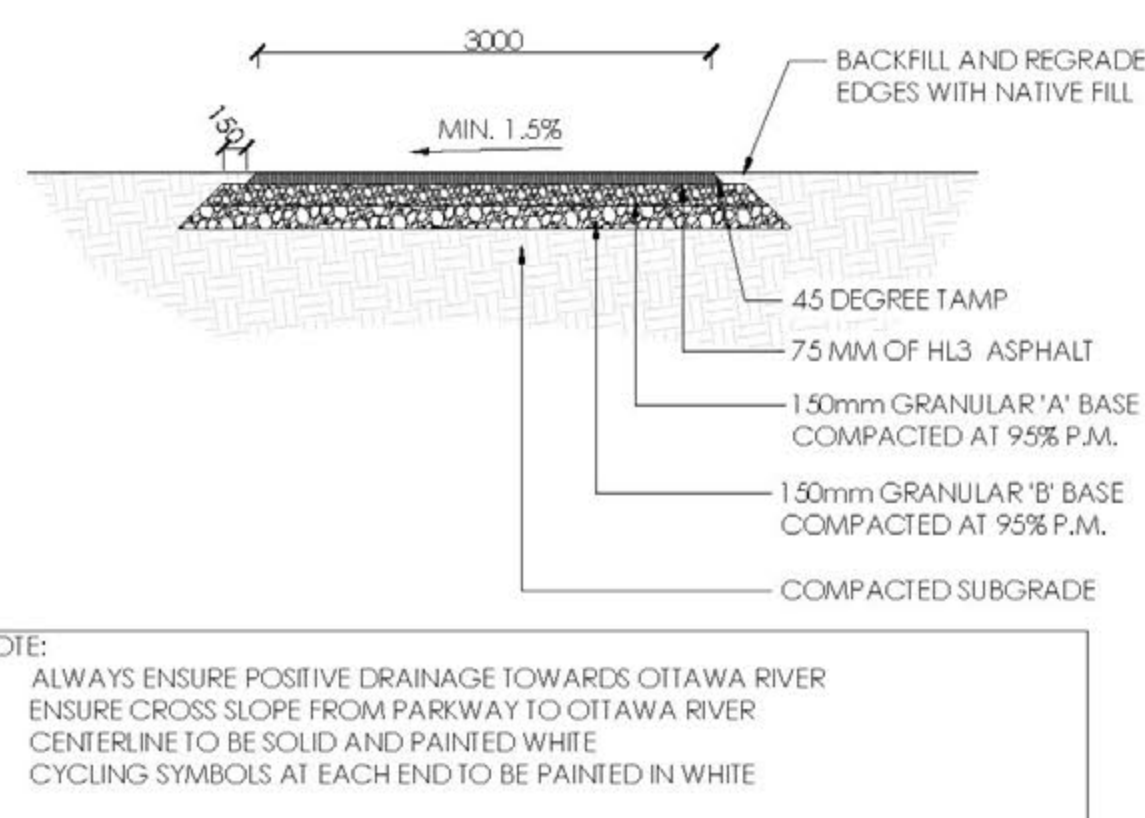

4 3M SOUTH CYCLING PATHWAY (FRASER TO ROCHESTER FIELD) (CLEARY AREA)
LA-11

issued or revised
émis ou révisé

no.	description	date
4	REVISION 3	22/02/18
3	REVISION 2	05/05/17
2	REVISION 1	12/04/17
1	100% DESIGN DEVELOPMENT	06/02/17

project
projet

SIR JOHN A. MACDONALD
RIVERFRONT LINEAR PARK /
PARC LINÉAIRE RIVERAIN
SIR-JOHN-A-MACDONALD

drawing
dessin

LANDSCAPE DETAILS 2
SOUTH OF SJAM

approved by
approuvé par S.FISHER

designed by
conçu par S.FISHER/S.DEGUIRE

drawn by
dessiné par S.DEGUIRE

date 13/09/16 scale
échelle AS NOTED

NCC project no.
no. du projet de la CCN sheet no.
no. de la feuille

DC 5205-16 LA-11

PLANT LIST

SYM.	BOTANICAL NAME	COMMON NAME	QTY.	SIZE	REMARKS
SHRUBS					
CM	CORNUS SANGUINEA 'MIDWINTER FIRE'	BLOODTWIG DOGWOOD	23	2G.	1.5m O/C
CY	CORNUS SERICEA 'BIRD'S YELLOW'	BIRD'S YELLOWTWIG DOGWOOD	13	2G.	1.5m O/C
JA	JUNIPERUS CHINENSIS 'AUREA'	GOLD COAST JUNIPER	55	3G.	0.90m O/C
PERENNIAL					
AF	AGASTACHE FOENICULUM	LAVENDER HYSSOP	12	1G.	0.45m O/C
BA	BAPTISIA AUSTRALIS	BLUE FALSE INDIGO	16	1G.	0.60m O/C
ER	ECHINACEA PURPUREA 'RUBINSTERN'	RUBY STAR CONEFLOWER	140	1G.	0.45m O/C
GRASSES					
SA	SESLERIA AUTUMNALIS	AUTUMN MOOR GRASS	59	1G.	0.50m O/C
SH	SPOROBOLUS HETEROLEPSIS	PRAIRIE DROPSEED	255	1G.	0.50m O/C

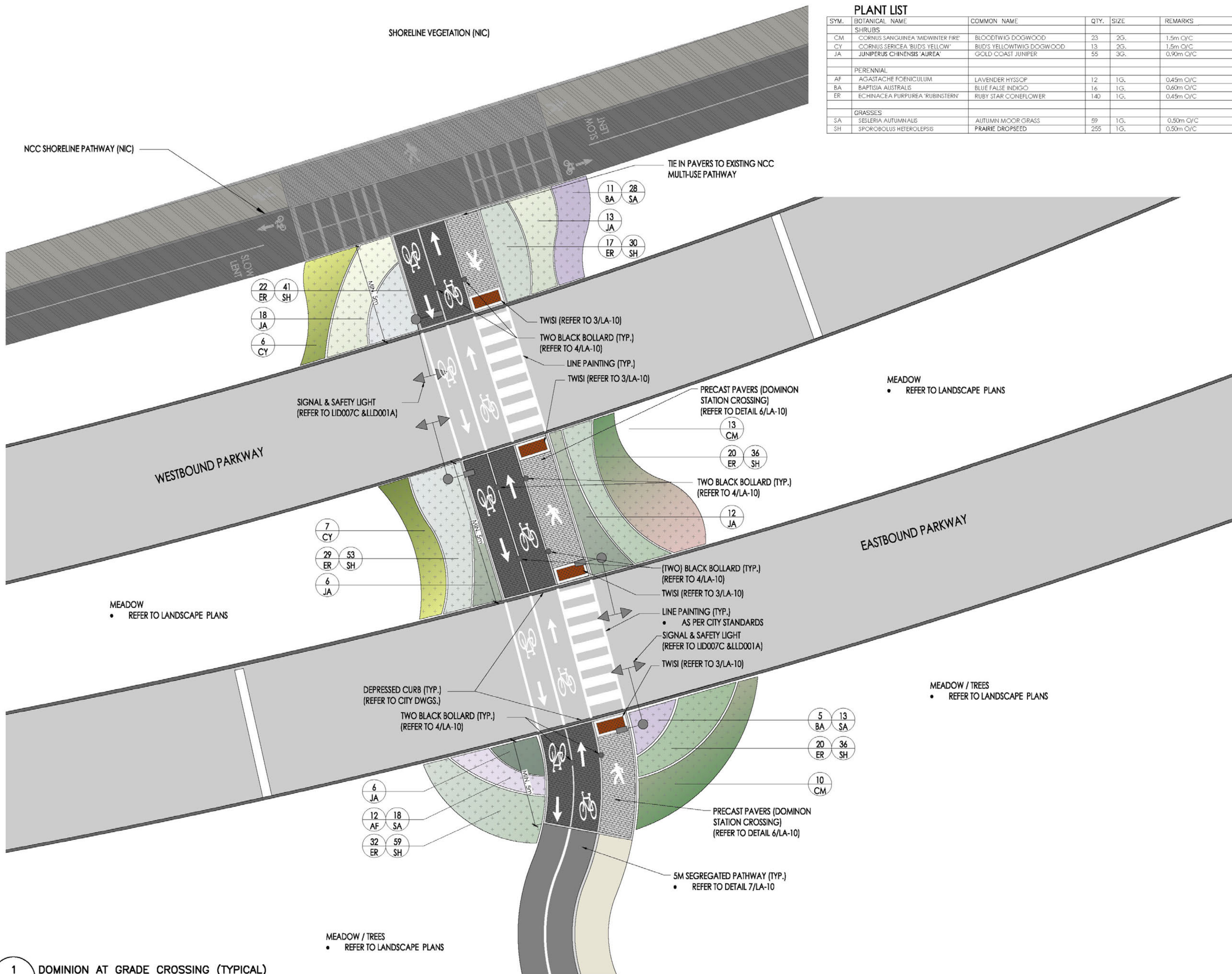

- NOTE:**
- ALL DRAWINGS ARE TO BE ADHERED TO. ALL CHANGES TO BE DISCUSSED WITH NCC AND TO BE SUBJECTS TO NCC FOR FINAL DETERMINATION OF ACCEPTANCE
 - LOCATION OF TRAFFIC CONTROL SIGNAL AND DISCONNECT FOUNDATION TO BE APPROVED BY NCC"

issued or revised
émis ou révisé

no.	description	date
4	REVISION 3	22/02/18
3	REVISION 2	05/05/17
2	REVISION 1	12/04/17
1	100% DESIGN DEVELOPMENT	06/02/17

project
projet

SIR JOHN A. MACDONALD
RIVERFRONT LINEAR PARK /
PARC LINÉAIRE RIVERAIN
SIR-JOHN-A-MACDONALD

drawing
dessin

LANDSCAPE DETAILS 3
TYPICAL AT GRADE
CROSSING

approved by
approuvé par S.FISHER

designed by
conçu par S.FISHER/S.DEGUIRE

drawn by
dessiné par S.DEGUIRE

date 13/09/16 scale 1/12
échelle NTS

NCC project no. 5205-16 sheet no. LA-12
no. du projet de la CCN no. de la feuille

**NATIONAL CAPITAL COMMISSION
CAPITAL PLANNING BRANCH; DESIGN AND CONSTRUCTION**

**SJAM RIVERFRONT LINEAR PARK
LANDSCAPE SOUTH OF SJAM**

Reference Number: DC-5205-16

Date: February 2017

INDEX - SPECIFICATIONS

<u>Division</u>	<u>Section</u>		<u>No. of pages</u>
03. Concrete	03 30 00.01	Cast-in-Place Concrete	8
31. Earthworks	31 22 13.01	Site Grading	3
	31 23 10	Excavation and Backfilling	2
32. Exterior Improvements	32 01 90.33	Shrub and Tree Protection	4
	32 11 23	Granular Materials	2
	32 11 30	Pathway Construction	2
	32 12 16	Asphalt Paving	2
	32 14 10	Unit Paving	2
	32 18 23	Pavement Markings and Signage	2
	32 37 00.01	Exterior Site Furnishings	2
	32 91 21	Topsoil and Finish Grading	3
	32 93 20.01	Seeding	5
	32 93 10.01	Tree and Shrub Planting	5
32 93 12.01	Plant Maintenance and Warranty	4	
32 93 45	Tree Pruning	2	

END OF SECTION

CAST-IN-PLACE CONCRETE

DC 5205-16

February 2017

1.0 GENERAL

1.1 REFERENCES

- .1 American Society for Testing and Materials (ASTM)
 - .1 ASTM C 260-06, Standard Specification for Air-Entraining Admixtures for Concrete.
 - .2 ASTM C 309-07, Standard Specification for Liquid Membrane-Forming Compounds for Curing Concrete.
 - .3 ASTM C 494/C 494M-08, Standard Specification for Chemical Admixtures for Concrete.
 - .4 ASTM C 1017/C 1017M-07, Standard Specification for Chemical Admixtures for Use in Producing Flowing Concrete.
 - .5 ASTM D 412-06ae1, Standard Test Methods for Vulcanized Rubber and Thermoplastic Elastomers-Tension.
 - .6 ASTM D 624-00(2007), Standard Test Method for Tear Strength of Conventional Vulcanized Rubber and Thermoplastic Elastomer.
 - .7 ASTM D 1751-04, Standard Specification for Preformed Expansion Joint Filler for Concrete Paving and Structural Construction (Nonextruding and Resilient Bituminous Types).
 - .8 ASTM D 1752-04a, Standard Specification for Preformed Sponge Rubber Cork and Recycled PVC Expansion Joint Fillers for Concrete Paving and Structural Construction.
- .2 Canadian General Standards Board (CGSB)
 - .1 CAN/CGSB-37.2-M88, Emulsified Asphalt, Mineral Colloid-Type, Unfilled, for Dampproofing and Waterproofing and for Roof Coatings.
 - .2 CAN/CGSB-51.34-M86(R1988), Vapour Barrier, Polyethylene Sheet for Use in Building Construction
- .3 Green Building Council of Canada (CaGBC)
 - .1 LEED Canada-NC Version 1.0-2004, LEED (Leadership in Energy and Environmental Design) Rating System for Green Building New Construction and Major Renovations (Reference Package) (including Addendum 2007).
 - .2 LEED Canada-CI Version 1.0-2007, LEED (Leadership in Energy and Environmental Design) Rating System for Sustainable Building interior commercial spaces
- .4 OPSS.MUNI 1010 Material Specification for Aggregates – Base, sub base, Subgrade Material and backfill material, November 2013.

CAST-IN-PLACE CONCRETE

DC 5205-16

February 2017

- .5 Canadian Standards Association (CSA International)
 - 1 CSA-A23.1/A23.2-F04, Concrete Materials and Methods of Concrete Construction/Methods of Test and Standard Practices for Concrete.
 - .2 CSA A283-06, Qualification Code for Concrete Testing Laboratories.
 - .3 CSA-A3000-F08, Cementitious Materials Compendium (Consists of A3001, A3002, A3003, A3004 and A3005).

1.2 RELATED SECTION

- .1 01 33 00 – Shop Drawing, Product Data and Samples
- .2 03 10 00.01 – Concrete forming and accessories
- .3 03 20 00.01 – Concrete reinforcing

1.3 SAMPLES

- .1 Submit required documents in accordance with Section 01 33 00 Shop Drawings, Products Data and Samples for review by NCC representative and do not proceed without written approval when deviations from mix design or parameters are found.
- .2 Concrete hauling time: submit for review by NCC representative, deviations exceeding maximum allowable time of 120 min for concrete to be delivered to site of Work and discharged after batching.

1.4 QUALITY ASSURANCE

- .1 Submit to NCC representative, minimum 1 week prior to starting concrete work, valid and recognized certificate from plant delivering concrete.
 - .1 When plant does not hold valid certification, provide test data and certification by qualified independent inspection and testing laboratory that materials used in concrete mixture will meet specified requirements.
- .2 Minimum 1 week prior to starting concrete work submit to NCC representative manufacturer's test data and certification by qualified independent inspection and testing laboratory that following materials will meet specified requirements:
 - .1 Falsework erection.
 - .2 Hot weather concrete.
 - .3 Cold weather concrete.
 - .4 Curing.
 - .5 Finishes.
 - .6 Formwork removal.
 - .7 Joints.
- .3 Quality Control Plan: submit written report, to NCC representative verifying compliance that concrete in place meets performance requirements of concrete as established in PART 2 - PRODUCTS.

CAST-IN-PLACE CONCRETE

DC 5205-16

February 2017

1.5 DELIVERY, STORAGE AND HANDLING

.1 Delivery and acceptance:

- .1 Concrete hauling time: maximum allowable time for concrete to be delivered to site of Work and discharged not to exceed 120 minutes after batching.
 - .1 Modifications to maximum time limit must be agreed to NCC representative and concrete producer as described in CSA A23.1/A23.2.
 - .2 Deviations to be submitted for review by NCC Representative
- .2 Concrete delivery: ensure continuous concrete delivery from plant meets CSA A23.1/A23.2.

2.0 PRODUCTS

2.1 SUSTAINABLE REQUIREMENTS

- .1 According to the CSA A23.1/A23.2 and indications of Article DOSAGE FORMS PART 2 standard - PRODUCTS.

2.2 SUSTAINABLE REQUIREMENTS

- .1 Quality Control Plan : Ensure that the concrete supplier is able to provide concrete meeting the performance criteria established by the NCC representative and provide control of the compliance of the material according to the requirements of article QUALITY ASSURANCE, PART 1.

2.3 MATERIALS

- .1 Cement: to CAN/CSA-A3001, Type GU.
- .2 Water: to CAN/CSA-A23.1.
- .3 Aggregates: to CAN/CSA-A23.1. Coarse aggregates to be normal density.
- .4 Admixtures
 - .1 Air entraining admixture: to ASTM C 260.
 - .2 Chemical Admixtures: ASTM C494 standard. The NCC representative must accept accelerators used during concrete work.
- .5 Shrinkage compensating grout: premixed compound consisting of non-metallic aggregate, Portland cement, water reducing and plasticizing agents.
 - .1 Compressive strength: XXXXXXXXXX.
- .6 Tactile walking surface strip indicators

CAST-IN-PLACE CONCRETE

- .1 Tactile walking surface indicators shall be made of cast iron, according to CSA B651-2012 and follow Ontario Regulation 191/11, and meet the following requirements:

Standard	Property	Minimum Result
ASTM A 8	tensile strength	
ASTM C 1028	slip resistance	
ASTM C 501-84	wear resistance	

- .2 The truncated domes shall be of uniform size and shape. Units shall be uniform in texture, be free from pouring faults, sponginess, cracks, blowholes, and other defects, and have clean-cut and well-defined edges. All surfaces shall be bare, without any coating, and be uniform and free of flaking rust or mounts of rust or debris. Tactile walking surface indicators shall have ribs cast to the underside of the unit, have vent holes, and have a minimum plate thickness of 5 mm.

2.4 GRANULAR BASE COURSE

- .1 Granular base course quality: sound, hard, durable material free from soft, thin, elongated or laminated particles, organic material, clay lumps or minerals, or other substances that would act in deleterious manner for use intended.
- .2 Any granular materials specified for the various works, on the drawings or in other sections of the specifications or by direction of the NCC Representative, shall conform OPSS.MUNI 1010 Material Specification for Aggregates – Granular A, B, M, and Select Subgrade Material
- .3 Blending to obtain the correct gradation shall be permitted when the Contractor demonstrates that he can produce a correct gradation and has a plant capable of producing to the satisfaction of the NCC Representative.
- .4 Granular "A" : This materials shall conform to OPSS.MUNI 1010.
- .5 Granular "B": This material shall conform to OPSS.MUNI 1010.
- .6 Select Subgrade material: See section 31 23 10 Excavation, Trenching and Backfilling
- .7 Provide samples as per Section 01 33 00 – Shop Drawings, Product data and Samples

2.5 MIXES

- .1 Alternative 1 - Performance Method for specifying concrete: to meet NCC representative performance criteria in accordance with CAN/CSA-A23.1/A23.2.
 - .1 Ensure concrete supplier meets performance criteria as established below and provide verification of compliance as described in quality control plan.
 - .2 Provide concrete mix to meet following hard state requirements:
 1. Durability and class of exposure: C-1.
 2. Minimum compressive strength at ████████████████████.
 3. Intended application: C-1
 4. Diameter of aggregates: at least 20 mm.
 5. Air entrained 5 to 8%
 - .3 Provide quality management plan to ensure verification of concrete quality to specified performance.
 - .4 Concrete supplier's certification.

CAST-IN-PLACE CONCRETE

DC 5205-16

February 2017

3.0 EXECUTION

3.1 PREPARATION

- .1 Obtain NCC representative's approval before placing concrete.
 1. Provide 48 hours notice prior to placing of concrete.
- .2 Place concrete reinforcing in accordance with Section 03 20 00.01 - Concrete Reinforcing
- .3 During concreting operations:
 1. Development of cold joints not allowed.
 2. Ensure concrete delivery and handling facilitates placing with minimum of re-handling, and without damage to existing structure or Work.
- .4 Pumping of concrete will not be permitted after approval of equipment and mix
- .5 Ensure reinforcement and inserts are not disturbed during concrete placement.
- .6 Prior to placing of concrete obtain NCC representative's approval of proposed method for protection of concrete during placing and curing in adverse weather.
- .7 Protect previous Work from staining.
- .8 Clean and remove stains prior to application for concrete finishes.
- .9 Maintain accurate records of poured concrete items to indicate date, location of pour, quality, air temperature and test samples taken.
- .10 In locations where new concrete is dowelled to existing work, drill holes in existing concrete.

3.2 IMPLEMENTATION

- .1 Do cast-in-place concrete work in accordance with CAN/CSA-A23.1.
- .2 Sleeves and inserts:
 - .1 Do not permit penetrations, sleeves, ducts, pipes or other openings to pass through joists, beams, column capitals or columns, except where indicated or approved by NCC representative.
 - .2 Sleeves and openings greater than 100 x 100 mm not indicated must be reviewed by NCC representative.

CAST-IN-PLACE CONCRETE

DC 5205-16

February 2017

- .3 Do not eliminate or displace reinforcement to accommodate hardware. If inserts cannot be located as specified, obtain approval of modifications from NCC Representative before placing of concrete.
 - .4 Check locations and sizes of sleeves and openings shown on drawings.
 - .5 Set special inserts for strength testing as indicated and as required by non-destructive method of testing concrete.
 - .3 Anchor bolts.
 - .1 Set anchor bolts to templates under supervision of appropriate trade prior to placing concrete.
 - .2 With approval of NCC Representative, grout anchor bolts in preformed holes or holes drilled after concrete has set.
 - .1 Formed holes to be minimum 100 mm diameter.
 - .3 Protect anchor bolt holes from water accumulations, snow and ice build-ups.
 - .4 Set bolts and fill holes with shrinkage compensating grout.
 - .4 Finishing and curing:
 - .1 Finish concrete in accordance with CAN/CSA-A23.1.
 - .2 Concrete Pads and concrete barrier curbs (type 01 & Type 02) finish: Magnesium trowel finish
 - .3 Concrete mountable curb and dropped sidewalk finish: as per City of Ottawa's Standards – meet and match existant.
 - .4 Rub exposed sharp edges of concrete with carborundum to produce 3 mm radius edges unless otherwise indicated.
 - .5 Proceed to the sawing of the slab 200 mm thick concrete as soon as the support without leaving workers impression 6 to maximum 18 hours after pouring of concrete.
- 3.3 SITE TOLERANCE
- .1 Concrete tolerance in accordance with CAN/CSA-A23.1 straight edge method.
- 3.4 FIELD QUALITY CONTROL
- .1 Inspection and testing of concrete and concrete materials will be carried out by a Testing Laboratory designated by Consultant in accordance with CAN/CSA-A23.1.
 - .1 Concrete pours.

CAST-IN-PLACE CONCRETE

DC 5205-16

February 2017

- .2 Slump tests.
- .3 Air entrained
- .4 Compressive strength at [REDACTED].
- .5 Ambient temperature and temperature of the concrete.
- .2 Inspection and testing of concrete and concrete materials will be carried out by testing laboratory designated by NCC Representative for review, to his satisfaction and in accordance with CSA-A23.1/A23.2. Testing of concrete and concrete materials will be paid by the Owner.
- .3 Contractor to paid repeat testing on fail sampling.
- .4 Ensure test results are distributed for discussion at pre-pouring concrete meeting between testing laboratory and NCC Representative.
- .5 Testing laboratory will take additional test cylinders during cold weather concreting. Cure cylinders on job site under same conditions as concrete which they represent.
- .6 Non-Destructive Methods for Testing Concrete: in accordance with CSA-A23.1/A23.2
- .7 Inspection or testing by NCC representative will not augment or replace Contractor quality control nor relieve Contractor of his contractual responsibility.

3.5 CLEANING

- .1 Perform cleanup as follow:
 - .1 Provide on-site, adequate space for safely washing concrete trucks.
 - .2 It is prohibited to dump unused adjuvants into sewers, in a stream, a lake, on the ground or any other place where it could pose a risk to health or the environment.
 - .3 Make the necessary arrangements to prevent contaminating adjuvants waterbodies or drinking water sources.
 - .4 If necessary, collect the liquid or solidify with an inert non-combustible taking all appropriate safety material.
 - .5 Remove and dispose of waste in accordance with the requirements of federal provincial territorial and local laws.

END OF SECTION

PART 1 GENERAL

1.1 REFERENCES

- .1 American Society for Testing and Materials (ASTM)
 - .1 ASTM D698, Test Method for Laboratory Compaction Characteristics of Soil Using Standard Effort (600 kN-m/m³).

1.2 Related section

- .1 01 35 43 – Environmental Protection
- .2 01 61 20 – Material & Equipment
- .3 31 23 10.01 – Excavation, Trenching and Backfilling
- .4 32 91 21.01 – Topsoil and Finish Grading

1.3 PROTECTION

- .1 Protect existing fencing, landscaping, natural features, bench marks, buildings, pavement, surface or underground utilities which are to remain as directed by NCC Representative. If damaged, restore to original or better condition unless directed otherwise.
- .2 Maintain access roads to prevent accumulation of construction related debris on roads.

PART 2 PRODUCTS

2.1 GRANULAR BASE COURSE MATERIAL

- .1 Granular base course quality: sound, hard, durable material free from soft, thin, elongated or laminated particles, organic material, clay lumps or minerals, or other substances that would act in deleterious manner for use intended.
- .2 Any granular materials specified for the various works, on the drawings or in other sections of the specifications or by direction of the NCC Representative, shall conform OPSS.MUNI 1010 Material Specification for Aggregates – Granular A, B, M, and Select Subgrade Material
- .3 Blending to obtain the correct gradation shall be permitted when the Contractor demonstrates that he can produce a correct gradation and has a plant capable of producing to the satisfaction of the NCC Representative.
- .4 Granular "A" : This materials shall conform to OPSS.MUNI 1010.
- .5 Granular "B": This material shall conform to OPSS.MUNI 1010.
- .6 Select Subgrade material: See section 31 23 10 Excavation, Trenching and Backfilling
- .7 Provide samples as per Section 01 33 00 – Shop Drawings, Product data and Samples

PART 3 EXECUTION

3.1 STRIPPING OF TOPSOIL AND TURF

- .1 Do not strip or disturb existing soil and turf, unless otherwise indicated.
- .2 Any excavated topsoil from site to be disposed of as per Section 01 61 10 - Management and Disposal of Excess Material.

- .3 No excavated material can be re-used as backfilling material.

3.2 PLACING

- .1 Place granular material to depth and grade in areas indicated.
- .2 Ensure no frozen material is placed.
- .3 Place material only on clean unfrozen surface, free from snow and ice.
- .4 Place material using methods which do not lead to segregation or degradation of aggregate.
- .5 Spread and shape material in uniform layers of required thickness.
- .6 Shape each layer to smooth contour and compact to specify density before succeeding layer is placed.
- .7 Remove and replace that portion of layer in which material becomes segregated during spreading.

3.3 GRADING, COMPACTING AND TESTING

- .1 Rough grade to levels, profiles, and contours allowing for surface treatment as indicated in the contract documents. Compact to specified density as shown on the contract drawings.
- .2 Shape and roll alternately to obtain smooth, even and uniformly compacted base.
- .3 Apply water as necessary during compacting to obtain specified density. If material is excessively moist, aerate by scarifying with suitable equipment until moisture content is corrected.
- .4 In areas not accessible to rolling equipment, compact to specified density with mechanical tampers.
- .5 Compaction and testing as per OPSS.MUNI 501.
- .6 Compaction tests to be paid by owner and performed by pre-approve testing agency.
- .7 Contractor to pay for repeat testing on fail samples.
- .8 Testing to be performed throughout progress of work to determine adequacy of compaction.
- .9 Co-operate with inspection staff during testing period.
- .10 Correct surface irregularities by loosening and adding or removing material until surface is within specified tolerance.
- .5 Do not disturb existing contaminated bare soil, soil within branch spread of trees or shrubs to remain unless otherwise specified by the NCC Representative.

3.4 PROTECTION

- .1 Maintain finished base in condition conforming to this Section until succeeding material is applied or until acceptance by NCC Representative.

3.5 CLEANING

- .1 Leave aggregate stockpile site in tidy, well drained condition, free of standing surface water.
- .2 For temporary or permanent abandonment of aggregate source, restore source to condition meeting requirements of authority having jurisdiction

3.6 SURPLUS MATERIAL

- .1 Remove surplus material and material unsuitable for fill, grading or landscaping as directed by NCC Representative.

END OF SECTION

PART 1- GENERAL

- 1.1 Related Work Specified Elsewhere
 - .1 Environmental Protection Section 01 35 43
 - .2 Site Work Demolition and Removals Section 02 41 13
 - .3 Site Grading Section 31 23 13
- 1.2 Utility Lines
 - .1 Before commencing work, establish location and extent of underground utility lines in area of excavation. Notify Contract Administrator of findings.
 - .2 Advise Contract Administrator to re-route existing lines in area of excavation. Costs for such work will be paid by Owner.
 - .3 Record locations of maintained and re-routed underground utility lines.
 - .4 Make good and pay for damage to existing utility lines resulting from work.
- 1.3 Protection
 - .1 Protect bottoms of excavations from softening. Should softening occur, remove softened soil and replace with material as directed by Contract Administrator.
 - .2 Protect bottoms of excavations from freezing.
 - .3 Provide adequate protection around bench markers, layout markers, survey markers, and geodetic monuments.
 - .4 Provide protection to ensure no damage to existing facilities and equipment situated on site.
 - .5 Effect approved measures to minimize dust as a result of this work.
 - .6 Do not stockpile excavated material to interfere with site operation or drainage.
- 1.4 Compaction Densities
 - .1 Compaction densities are percentages of maximum densities obtainable from ASTM D698-70.

PART 2 - PRODUCTS

- 2.1 Materials
 - .1 Backfill: native fill as per Section 31 22 13 – Site Grading.
- 2.2 Stockpiling
 - .1 Stockpile fill materials in areas designated by Contract Administrator. Stockpile native fill in a manner to prevent segregation. Protect stockpiled fill material from freezing.
 - .2 Protect fill materials from contamination.

PART 3- EXECUTION

- 3.1 Excavating
 - .1 Excavate to elevations and dimensions indicated for installation, construction and inspection of work specified.
 - .2 Excavate all vegetation and surficial organic material (topsoil, rootmat, peat, etc.)
 - .3 Excavate to well defined lines to minimize quantity of fill material required.
 - .4 Earth bottoms of excavations to be dry undisturbed soil, level, free from loose or organic matter.
 - .5 Notify Contract Administrator when bottom of excavation is reached
 - .6 Obtain Contract Administrator's approval of completed excavation.
 - .7 Keep excavation free of water while work is in progress.
 - .8 Protect open excavations against flooding and damage due to surface run off.
 - .9 Provide sediment control measures in accordance with Section 01 35 43 and as indicated

- elsewhere in the contract.
- .10 Excavation must not interfere with normal 45 degree splay of bearing from bottom of any footing.
 - .11 When complete, have Contract Administrator inspect excavations to verify soil bearing capacity, depths and dimensions.
 - .12 Correct unauthorized excavation at no extra cost as follows:
 - .1 Fill under bearing surfaces with Select Subgrade Material compacted to 95% SPMDD as directed by Contract Administrator.
 - .13 Do not disturb soil within branch spread of trees or shrubs that are to remain. If excavating through roots, excavate by hand and cut roots with sharp saw.
 - .14 Remove concrete masonry, paving, walks, rubble and other obstructions encountered in course of excavation.
 - .15 Dispose of all excavated non re-usable material off site.
 - .16 Do not obstruct flow of surface drainage or natural watercourses.

3.2 Backfilling

- .1 Do not commence backfilling until areas of work to be backfilled have been inspected and approved by Contract Administrator.
- .2 Areas to be backfilled and backfill material must be free from debris, snow, ice, water or frozen ground.
- .3 Prior to installation of granular materials, compact existing subgrade to obtain required bearing capacity. Remove "**soft**", unstable or weak subgrade materials and fill with approved material.
- .4 Backfill simultaneously each side of walls and other structures to equalize soil pressures.
- .5 Where temporary unbalanced earth pressures are liable to develop on walls or other structures, erect bracing or shoring to counteract unbalance, and leave in place until removal is approved by Contract Administrator.
- .6 Place and compact fill materials in continuous horizontal layers not exceeding 150 mm compacted depth. Compact to at least 95% Standard Proctor Maximum Dry Density. Compact each layer before placement of the next layer.
- .7 Use methods to prevent disturbing or damaging buried services. Make good any damage.

3.3 Surplus Material

- .1 Dispose of material unsuitable for fill, grading or landscaping off site.

END OF SECTION

PART 1 - GENERAL

1.1 Section Includes

- .1 Materials and installation for fertilizing and preserving root systems of plants affected by changing grades or excavation.
- .2 Materials and installation of ground protection and other measures as deemed necessary to protect existing trees according to contract drawings and conditions outlined in this section.

1.2 Related Sections

- .1 Section 01 33 00 – Submittal Procedures
- .2 Section 01 56 00 – Temporary Barriers and Enclosures
- .3 Section 01 74 19 – Waste Management

1.3 References

- .1 Canadian Standards Association (CSA International)
 - .1 CSA G30.5-M1983 Welded Steel Wire Fabric for Concrete Reinforcement.
- .2 Department of Justice Canada
 - .1 Canadian Environmental Protection Act (CEPA), 1999, c.33.
 - .2 Fertilizers Act (R.S. 1985, c. F-10).
 - .3 Fertilizers Regulations (C.R.C., c. 666).
 - .4 Transportation of Dangerous Goods Act (TDGA), 1992, c.34.
- .3 Health Canada - Pest Management Regulatory Agency (PMRA)
 - .1 National Standard for Pesticide Education, Training and Certification in Canada 1995.
- .4 Health Canada/Workplace Hazardous Materials Information System (WHMIS)
 - .1 Material Safety Data Sheets (MSDS).

1.4 Submittals

- .1 Submittals in accordance with Section 01 33 00 - Submittal Procedures.
- .2 Submit monthly written reports on maintenance during warranty period to the NCC Representative identifying:
 - .1 Maintenance work carried out.
 - .2 Development and condition of plant material.
 - .3 Preventative or corrective measures required which are outside Contractor's responsibility.

1.5 Delivery, Storage and Handling

- .1 Separate waste materials for reuse and recycling in accordance with Section 01 74 19 – Waste Management.
- .2 Place materials defined as hazardous or toxic in designated containers.
- .3 Dispose of unused fertilizer material at official hazardous material collections site approved by the NCC Representative.
- .4 Handle and dispose of hazardous materials in accordance with CEPA, TDGA, regional and municipal regulations.
- .5 Do not dispose of unused fertilizer material into sewer system, into streams, lakes, onto ground in any other location where they will pose health or environmental hazard.
- .6 Ensure emptied containers are sealed and stored safely.

1.6 Scheduling

- .1 Obtain approval from the NCC Representative of schedule indicating beginning of Work.

1.7 Maintenance during Warranty Period

- .1 From time of acceptance by the NCC Representative to end of warranty period, perform following maintenance operations.
 - .1 Water to maintain soil moisture conditions for optimum growth and health of plant material without causing erosion.
 - .2 Apply fertilizer in early spring at manufacturer's suggested rate.
 - .3 Remove dead, broken or hazardous branches from plant material. Seek approval from NCC Representative prior to removing any branches. Pruning may only be carried out by a certified arborist.
 - .4 During periods of extended drought, wind or grading, trunks, limbs and foliage should be sprayed with water to remove accumulated construction dust.
 - .5 Maintain tree protection fencing in good repair.
 - .6 Maintain ground protection in good repair.

PART 2 - PRODUCTS

2.1 Materials

- .1 Fertilizer:
 - .1 To Canada Fertilizer Act and Fertilizers Regulations.
 - .2 Complete, commercial, slow release with 35 % of nitrogen content in water-insoluble form.
- .2 Anti-desiccant: commercial, wax-like emulsion.
- .3 Water: potable - free from impurities that inhibit growth.

2.2 Tree Protection Fencing

- .1 The modular construction fencing shall act as the tree protection fencing. Refer to Section 01 56 00 – Temporary Barriers and Enclosures.

2.3 Ground Protection

- .1 Mulch: 2" unpainted, untreated wood chip or bark mulch.
- .2 Granular A.
- .3 Steel plates.

PART 3 - EXECUTION

3.1 Identification and Protection

- .1 Do construction occupational health and safety in accordance with Section 01 35 30 – Health and Safety.
- .2 The trees on this site are ceremonial trees and are designated cultural assets of great importance. They are considered irreplaceable.
- .3 Extreme care must be taken to protect existing trees (including crown, trunk and root system) from damage, compaction and contamination during all stages of work. The roots of a tree can extend from the trunk to approximately 2-3 times the distance of the dripline.
- .4 No material, construction equipment, or vehicles are to be stored in the tree protection zone (TPZ) or within the critical root zone (drip line) of trees at any time.
- .5 No movement of vehicles, equipment or pedestrian in the TPZ will be permitted.
- .6 The use of tree trunks as a backstop, winch support, anchorage, as a temporary power pole, signpost or other similar function is prohibited.

- .7 Any disturbed vegetation or landscaping will be repaired or replaced without delay to the satisfaction of the NCC Representative.
- 3.2 Tree Protection Fencing (Green colored)**
- .1 Supply and install **Green** colored tree protection fencing to protect existing trees.
 - .2 Tree protection fencing must be installed before construction begins and equipment arrives on site and maintained until the project is completed.
 - .3 Removal of fences, even temporarily to allow deliveries or equipment access is not allowed unless approved by the NCC Representative and ground protection is installed.
- 3.3 Ground Protection within the Critical Root Zone**
- .1 Ground protection must be installed before construction begins and equipment arrives on site and maintained until the project is completed.
 - .2 In areas where the critical root zone cannot be fenced and is within the limits of work, wood chip or bark mulch must be installed to a minimum depth of 6", followed by a layer of Granular A with ¾" plywood sheets laid on top. Steel plates can also be used in place of plywood. Leave the tree trunks clear of mulch. Install where indicated in the drawings and as directed by the NCC Representative to protect the sensitive root zone.
 - .3 Asphalt removal from within the critical root zone must be supervised by a certified arborist. Once removed, the granular base shall be protected from repeated compaction from vehicular circulation by the placement of steel plates.
- 3.4 Excavation within the Critical Root Zone**
- .1 Limits of excavation to be approved by the NCC Representative prior to commencing work.
 - .2 Hand digging, hydraulic, or pneumatic excavations are permitted methods for excavation within the critical root zone.
 - .3 Do not cut or damage roots greater than 25mm (1") diameter. When larger roots are encountered, consult a certified arborist before proceeding. If there are no roots greater than 25mm diameter, leave at least two (2) of the largest roots per meter of trench. Retain as many roots as possible.
 - .4 Prune roots that must be removed using sharp, clean tools such as secateurs or a landscape handsaw. Make a clean cut and leave as small a wound as possible. All root pruning to be supervised by a certified arborist.
 - .5 If any roots are exposed during construction, they should be immediately reburied with soil or wrapped in peat moss and burlap and kept moist until they can be buried permanently. Avoid exposing roots during hot, dry weather.
 - .6 Directional micro-tunneling and boring may be permitted within the limits of the critical root zone subject to the approval of the NCC Representative.
 - .7 Open face cuts that are consistent with an approved plan and that require root pruning, require the services of a certified arborist. An exploratory dig, either by hand or using a low water pressure hydro vacuum, or air spade method, must be completed prior to commencing with open face cuts.
- 3.5 Lowering Grade Around Existing Tree**
- .1 Begin Work in accordance with schedule approved by the NCC Representative.
 - .2 Cut slope not less than 500 mm from tree trunk to new grade level.
 - .3 Excavate to depths as indicated. Protect from damage root zone which is to remain.
 - .4 When severing roots at excavation level, cut roots with sharp tools.
 - .5 Cultivate excavated surface manually to 15 mm depth.
 - .6 Prepare homogeneous soil mixture consisting by volume of:
 - .1 60 % excavated soil cleaned of roots, plant matter, stones, debris.

- .2 25 % coarse, clean sterile sand.
- .3 15 % organic matter.
- .4 Grade 2:12:8 fertilizer at rate of 1.5 kg/m³.
- .7 Place soil mixture over area of excavation to finished grade level. Compact to 85 % Standard Proctor Density.
- .8 Water entire root zone to optimum soil moisture level.

3.6 Watering

- .1 Ensure that the ongoing maintenance and irrigation of the site vegetation is performed by a qualified contractor, while the construction hoarding is in place.
- .2 During the construction period, water existing trees within protected areas by applying water to surface, soaking area 1.5 times the diameter of the dripline of each tree.
- .3 Watering schedule to be approved by the NCC Representative.

3.7 Damage to Trees

- .1 Any damage or injury to trees shall be reported as soon as possible to the NCC Representative.
- .2 A substantial fine, as determined by the NCC Representative, may be enforced for any damage to the trees including unauthorized pruning.

3.8 Pruning

- .1 If pruning is required, consult an arborist and seek approval from the NCC Representative.
- .2 Prune in accordance with Section 32 93 45 - Tree Pruning.
- .3 Prune crown to compensate for root loss while maintaining general form and character of plant.

3.9 Anti-Desiccant

- .1 Apply anti-desiccant to foliage where applicable and as directed by the NCC Representative.

END OF SECTION

PART 1 – GENERAL

1.1 Related Work

- .1 Excavating and Backfilling Section 31 23 10
- .2 Pathway Construction Section 32 11 30

1.2 References

- .1 Ontario Provincial Standard Specification (OPSS):
 - .1 OPSS 1010 Material Specification for Aggregates – Granular A and B.

PART 2 – PRODUCTS

2.1 Materials -
General Requirements

- .1 Any granular materials specified for the various works, on the drawings or in other sections of the specifications or by direction of the Contract Administrator, shall conform to this material specification for the class of granular material required.
- .2 The materials shall be selected or produced from pits or quarries to conform to the requirements specified herein for each class of granular materials.
- .3 Material retained on the number 4 sieve shall consist of hard durable particles or fragments of stone or gravel.
- .4 Materials that break up when alternatively frozen and thawed or wetted and dried shall not be permitted.
- .5 Fine aggregate passing the Number 4 sieve shall consist of natural or crushed sand, and, material passing the Number 200 sieve shall consist of fine mineral particles.
- .6 The material shall be free from vegetable matter and lumps or balls of clay.
- .7 The material shall be non-plastic and non-frost susceptible.
- .8 Blending to obtain the correct gradation will be permitted when the Contractor demonstrates that he can produce a correct gradation and has a plant capable of producing to the satisfaction of the Contract Administrator.
- .9 The Contractor shall advise the Contract Administrator two weeks in advance of the intent use of any of the specified materials to allow sufficient time for sampling and testing. The Contractor shall submit samples of granular materials to be used in the works if so requested by the Contract Administrator.
- .10 Approval of a sample does not mean acceptance of the whole

GRANULAR MATERIALS

source. Each load of material received at the job site shall be subject to all the requirements of that material.

- .11 All gradation requirements are shown as percentage by weight passing U.S. Standards Sieves, A.A.S.H.O. M-92-65.

2.2 Materials:
Specific Requirements

- .1 Granular "A":
 - .1 This material shall conform to OPSS 1010.
- .2 Granular "B" Type II
 - .1 This material shall conform to OPSS 1010
- .3 Granular "D" (stonedust):
 - .1 This material shall be crushed rock screenings or stone dust.
 - .2 Gradation Requirements:

<u>Sieve</u>			<u>% Passing</u>
9.5	mm	(3/8")	
4.75	mm	(No. 4)	
1.18	mm	(No. 16)	
300	um	(No. 50)	
75	um	(No. 200)	

- .4 Select Subgrade Material (SSM):
 - .1 As per Section 31 23 10.

END OF SECTION

PART 1- GENERAL

- | | | | |
|-------------------|----|---|------------------|
| 1.1 Related Works | .1 | Excavating and Backfilling | Section 31 23 10 |
| | .2 | Geotextiles | Section 31 32 21 |
| | .3 | Granular Materials | Section 32 11 23 |
| | .4 | Concrete Sewer and Pipe Culverts | Section 33 42 13 |
| 1.2 Protection | .1 | Prevent damage to buildings, landscaping, curbs, sidewalks, roads and trees. Make good on any damage. | |

PART 2- PRODUCTS

- | | | | |
|---------------|----|--|--|
| 2.1 Materials | .1 | Granular "A": as per Section 32 11 23 | |
| | .2 | Granular "B" Type II as per Section 32 11 23 | |
| | .3 | Granular "D" as per Section 32 11 23 | |
| | .4 | Geotextiles as per Section 31 32 21 | |

PART 3- EXECUTION

- | | | | |
|-----------------------|----|---|--|
| 3.1 Layout of Pathway | .1 | Notify Contract Administrator after completion of each stage and receive approval of layout prior to proceeding to next stage. Stages:
.1 Staking of centerline.
.2 Subgrade
.3 Sub-base
.4 Prior to laying of Granular D, Contract Administrator to inspect alignment and grades | |
| | .2 | All curves shall be true. No tangents shall be accepted at the beginning or end of curves. Obtain approval of Contract Administrator on site during work. | |
| 3.2 Inspection | .1 | Check graded subgrade for conformity with elevations and sections before placing granular base materials and obtain approval of Contract Administrator. | |
| | .2 | Proof roll graded subgrade surface with a heavy smooth drum roller (weight and type of roller to be approved by Contract Administrator).
.1 Check for unstable areas.
.2 Check for areas requiring additional compaction.
.3 Notify Contract Administrator of unsatisfactory conditions. | |
| 3.3 Sub-base | .1 | Refer to Section 31 23 10, Excavating and Backfilling | |
| 3.4 Base Course | .1 | Place Granular 'A' and Granular 'B' base materials to compacted thickness as indicated. | |

- .2 Place in layers not exceeding 150mm compacted thickness. Compact each layer to 100% maximum dry density as determined by Standard Proctor Density.
- .3 Obtain approval of Contract Administrator prior to laying of stonedust .

3.5 Surface Course

- .1 Place stonedust surface course to compacted thickness as indicated and compact to 98% SPMDD.

3.6 Reinstatement of Edges

- .1 Reinststate edges of pathway with approved earth fill and topsoil as indicated.

END OF SECTION

PART 1 - GENERAL

- 1.1 Related Works Specified Elsewhere
 - .1 Excavating and Backfilling Section 31 23 10
 - .2 Granular Materials Section 32 11 23
 - .3 Pathway Construction Section 32 11 30

- 1.2 References
 - .1 Ontario Provincial Standard Specification (OPSS):
 - .1 310, 311
 - .2 City of Ottawa Special Provisions 2009:
 - .1 F-3104
 - .3 City of Ottawa Standard Detailed Drawings 2009:
 - .1 R-10

- 1.3 Protect existing items designated to remain and materials designated for salvage and relocation. In event of damage, immediately replace such items or make repairs to the satisfaction of Contract Administrator and at no additional cost to the Commission.

- 1.4 Site Conditions
 - .1 Contractor to contact appropriate utilities to verify presence and location of all overhead and underground services and establish location for all such services in the field before commencing work. Report any discrepancies to Contract Administrator

- 1.5 Basis of Payment
 - .1 Basis of payment clauses included in references are deleted in their entirety and will be measured and paid as per Section 01 10 00 – Pay Items Description

PART 2 - PRODUCTS

- 2.1 Materials
 - .1 Performance Graded HL3 Hot Mix Asphalt – (Beige colored and black colored) submit samples prior to commencement of work. :
 - .1 This material shall conform to OPSS 310 as amended by City of Ottawa Special Provisions F-3104

 - .2 Tack Coat - (Beige colored and black colored) submit samples prior to commencement of work. :
 - .1 This material shall conform to OPSS 310 as amended by City of Ottawa Special Provision F-3107

PART 3 - EXECUTION

- 3.1 Asphalt Paving
 - .1 The Contractor shall notify the Contract Administrator five (5) days prior to paving.
 - .2 The Contractor must obtain the Contract Administrators approval before placing any asphalt.
 - .3 Asphalt is to be placed to thicknesses, grades and lines as shown on plans or as indicated by the Contract Administrator
 - .4 The Contractor paving shall be conducted as specified in OPSS 310 or as directed by the Contract

Administrator

- .5 Step joints shall be used as indicated where new asphalt will connect to existing pavement

3.2 Quality Control and Assurance

- .1 OPSS 310 sub-sections 310.07.01 and 310.07.05 are deleted in their entirety.
- .2 The Contractor must supply a minimum of one (1) quality assurance sample and one (1) referee sample to the Contract Administrator. The samples shall be randomly chosen or as directed by the Contract Administrator. The Contract Administrator may request additional samples.
- .3 The samples shall be delivered within 4 hours to a location as specified by the Contract Administrator.
- .4 Samples shall be accompanied by the City of Ottawa 'Quality Assurance Sample Data Sheet' for Hot Mix Asphalt and completed to the satisfaction of the Contract Administrator.

3.3 Compaction

- .1 Compaction requirements shall be as specified in OPSS sub-section 310.08.015.03 and meet the requirements specified in OPSS 310, Table 9, to the satisfaction of the Contract Administrator
- .2 The Contractor shall conduct the compaction testing and supply the Contract Administrator with the results.

END OF SECTION

PART 1- GENERAL

1.1 RELATED SECTIONS

- .1 Section 31 23 10 – Excavation and Backfilling
- .2 Section 31 05 17 – Granular Materials

1.2 PROTECTION

- .1 Prevent damage to landscaping, curbs, sidewalks, trees, fences, roads and adjacent property. Make good any damage.

1.3 SAMPLES

- .1 Submit a full-size sample of each type of unit paver used.
- .3 Install a mock-up of pavers layout for NCC Representative approval's before commencement of work. Mock-up to be at minimum 1m x 1m.

PART 2- PRODUCTS

2.1 MATERIALS

- .1 Prefabricated concrete unit pavers:
 - .A Dimension : 100x300x100mm
Range color: Dark Grey
Finish: Smooth
 - .b Dimension : 100x300x100mm
Range color: Light Grey
Finish: Smooth
- .2 On granular base: 150mm granular 'A' & 150mm granular 'B'
- .3 Laying Course: dry clean masonry sand, 25mm thickness
- .4 Joint materials: Polymeric Sand, dark Grey colour
- .5 Edge Restraint: Flexible PVC such as SNAP EDGE (or approved equal) with min 300mm spikes at 300mm O.C..

PART 3- EXECUTION

3.1 SUBGRADE

- .1 Ensure that subgrade preparation conforms to levels and compaction required to allow for installation of granular base.

- .1 Ensure that subgrade preparation conforms to levels and compaction required to allow for installation of granular base.

3.2 GRANULAR BASE

- .1 Place base to compacted thicknesses as indicated on drawings.
- .2 Compact to a density of not less than 95% Standard Density in accordance with ASTM D698.
- .3 Shape and roll alternately to obtain a smooth, even and uniformly compacted granular base and ensure conformity of grades with finish surface.
- .4 Apply water as necessary during compaction to obtain specified density. If granular base is excessively moist, aerate by scarifying with suitable equipment until moisture content is corrected.
- .5 In areas not accessible to rolling equipment, compact to specified density with approved mechanical tampers.
- .6 Ensure top of granular base does not exceed plus or minus 10 mm of finished grade, less combined thickness of sand laying course plus concrete unit pavers.

3.3 LAYING COURSE

- .1 Place masonry sand laying course to compacted thickness as indicated on drawings.
- .2 Ensure laying course is dry (4-8% moisture content) prior to placement of unit pavers.

3.4 SURFACE COURSE

- .1 Install unit paving true to grade, in location, layout and pattern as indicated on drawings.
- .2 Install stone step tight to building face, and in same manner as unit paving on granular base and sand levelling course (slope step away from building).
- .3 Where required, cut unit pavers accurately without damaging edges.
- .4 Tamp down and level pavers with mechanical plate vibrator on minimum 19 mm thick plywood until pavers are true to grade and free of movement.
- .5 Fill spaces between pavers by sweeping polymeric sand into joints, vibrating, wetting and cleaning as per manufacturer's instructions. Completely fill joints.
- .6 Surface of finished pavement: free from depressions exceeding 5 mm as measured with 3 m straight edge.
- .7 Sweep surface course clean.

END OF SECTION

PART 1 - GENERAL

- 1.1 Related Works Specified Elsewhere
 - .1 Site Work Demolition and Removals Section 02 41 13
 - .2 Asphalt Paving Section 32 12 16
- 1.2 Basis of Payment
 - .1 Basis of payment clauses included in references are deleted in their entirety and will be measured and paid as per Section 01 10 00 – Pay Items Description

PART 2 - PRODUCTS

- 2.1 .1 Paint:
 - .1 To CGSB 1-GP-74M, alkyd traffic paint.
 - .2 Color: white
 - .3 Upon request, NCC Representative will supply a qualified product list of paints applicable to work. Qualified paints may be used but NCC Representative reserves right to perform further tests.
- .2 Thinner: to CGSB 1-GP-5M.
- .3 Templates and Stencils: as required to produce symbols as indicated on drawings. Submit manufacturer's data including size of each stencil.
- 2.2 EQUIPMENT REQUIREMENT
 - .1 Paint applicator to be an approved pressure type mobile distributor capable of applying paint in single solid lines. Applicator to be capable of applying marking components uniformly, as rates specified, and to dimensions as indicated, and to have positive shut-off.

PART 3 - EXECUTION

- 3.1 CONDITIONS OF SURFACES
 - .1 Pavement surface to be dry, free from ponded water, frost, ice, dust, oil, grease and other foreign materials.
 - .2 Remove existing markings that will interfere with legibility of new painted lines and symbols.
- 3.2 APPLICATION
 - .1 Lay out pavement markings and obtain approval by NCC Representative.
 - .2 Unless otherwise approved by NCC Representative, apply paint only when air temperature is above 10°C, wind speed is less than 60 km/h and no rain is forecast within next 4 h.
 - .3 Apply traffic paint evenly at rate of 3 m²/L.
 - .4 Do not thin paint unless approved by NCC Representative.
 - .5 Symbols and letters to conform to dimensions indicated.
 - .6 Paint lines to be of uniform color and density with sharp edges.
 - .7 Width of paint lines to be 65 mm.
 - .8 Thoroughly clean distributor tank before refilling with paint.

- 3.3 TOLERANCE
- .1 Paint markings to be within plus or minus 12 mm of dimensions indicated.
 - .2 Remove incorrect markings as indicated by NCC Representative.
- 3.4 PROTECTION OF WORK
- .1 Protect pavement markings until dry.

END OF SECTION

PART 1- GENERAL

1.1 RELATED SECTION

- .1 01 33 00 - Shop Drawing, product data and samples

1.2 SUBMITTALS

- .1 Submit product data in accordance with Section 01 33 00 – Shop Drawing, product data and samples
- .2 Submit required shop drawings in accordance with Section 01 33 00 - Shop Drawing, product data and samples.
- .3 Indicate dimensions, sizes, assembly, anchorage and installation details for each furnishing specified.
- .4 Provide maintenance data for care and cleaning of site furnishings.

1.3 DELIVERY, STORAGE AND HANDLING

- .1 Damaged furniture and components will not be accepted and will have to be replaced at no charge for the NCC.

PART 2- PRODUCTS

2.1 BENCHES

- .1 Type: Model C-140 from the [REDACTED] as supplied by [REDACTED].
 - Specifications:
 - .1 C-140 components
 - .2 6 foot length
 - .3 Standard metalwork color: black
 - .4 2x3 IPE Slats
 - .5 No stain
 - Installation :
 - .1 Install and secure to asphalt covered concrete base (refer to landscape plans)
 - .2 Clearance for 3/8" (10mm) anchor bolts (anchor bolts to be provided by contractor)
 - .3 Mounting: It is not recommended to locate anchor bolts until bench is in place.

2.2 WASTE RECEPTACLE

- .1 Type: Model S-42 from the [REDACTED] as supplied by [REDACTED].
 - .1 Standard metalwork color: black
 - .2 Mounting plate: (3) anchor bolt holes.
 - Installation :
 - .1 Install and secure to asphalt covered concrete base (refer to landscape plans)
 - .2 Clearance for 3/8" (10mm) anchor bolts (anchor bolts to be provided by contractor)

- .3 Mounting: It is not recommended to locate anchor bolts until bench is in place.

2.3 BOLLARD (BLACK) - FIXED BOLLARD

- .1 Model: Maglin MTB500-B1 Bollard
 - a. Dimensions:
 1. Height: 34.5" (87.6 cm)
 2. Diameter: 4.5" (11.4 cm)

PART 3- EXECUTION

3.1 INSTALLATION

- .1 Assemble furnishings in accordance with manufacturer's instructions.
- .2 Install furnishing true, plumb, anchored and firmly supported, as indicated by the NCC Representative.
- .3 Touch-up damaged finishes to approval of the NCC Representative.

END OF SECTION

PARTIE 1 - GENERAL

1.1 Related Work Specified Elsewhere

- | | |
|-----------------------------|------------------|
| .1 Excavating & Backfilling | Section 31 23 10 |
| .2 Seeding | Section 32 92 20 |
| .3 Sodding | Section 32 92 23 |

1.2 Testing

- .1 Obtain Contract Administrator's initial approval of imported topsoil at source.
- .2 Test existing and imported topsoil for NPK, Mg, soluble salt content, organic matter and pH value prior to delivery to site.
 - 1 Submit 0.5 kg sample of topsoil to testing laboratory and indicate intended use.
 - 2 Determine requirements for amendments to bring pH value of soil to 5.5 to 7.7 level.
 - 3 Submit two copies of soil analysis and recommendations for corrections to Contract Administrator.
 - .4 Inspection and testing of topsoil will be carried out by testing laboratory designated by Contract Administrator.
 - .5 National Capital Commission will pay cost of testing.

1.3 Scheduling of Work

- .1 Schedule placing of topsoil to permit immediate seeding and sodding operations.

PARTIE 2 - PRODUCTS

2.1 Bioswale soil (Atlantis parking area)

Mix ratio:

50% sand (0.05-2mm)

30% soil consisting of:

50-85% sand

0-50% silt (0.002-0.05mm)

10-20% clay (<0.002mm)

- 1.5-10% organic matter
- 20% well decomposed, stable compost, free of weeds and weed seeds
- pH: 5.5-7.5

2.2 [REDACTED] (seeding and reforestation soil amendment areas)

[REDACTED] as supplied by [REDACTED] or approved equal. Submit sample and name of supplier five (5) days in advance and obtain approval by NCC representative prior to shipping to site.

2.3 [REDACTED] (soil amendment under existing trees within seeding area)

[REDACTED] as supplied by [REDACTED] or approved equal. Submit sample and

name of supplier five (5) days in advance and obtain approval by NCC representative prior to shipping to site.

2.4 Topsoil: (imported should be avoided, re-use on site soil for all grading requirements)

- .1 Stockpiled topsoil: see Section 31 23 10
- .2 If additional soil is required, it should meet the following requirements: friable loam, neither heavy clay nor of very light sandy nature containing minimum of 10% organic matter for sandy loams to maximum of 25% by volume. Free from subsoil, roots, grass, weeds, toxic materials, stones, foreign objects and an acidity range (Ph) of 5.5 to 7.5. Topsoil containing crabgrass, couch grass or other noxious weeds, not acceptable.

PARTIE 3 - EXECUTION

3.1 Preparation

- .1 Grade subgrade, eliminating uneven areas and low spots, ensuring positive drainage. Remove stones larger than 50 mm diameter and other deleterious materials. Remove subsoil that has been contaminated with oil, gasoline or calcium chloride. Dispose of removed materials as directed.
- .2 Cultivate entire area receiving topsoil to depth of 50 mm. Core aerate in those areas where equipment used for hauling and spreading has compacted subgrade. Do not cultivate soils around existing trees and shrubs.

3.2 Reuse of Existing Topsoil

- .1 Unless otherwise indicated existing stockpiled topsoil shall be used for all reinstatement. Imported sources of topsoil shall only be used when all approved sources of existing topsoil have been used.

3.3 Spreading of Topsoil

- .1 Do not spread topsoil until Contract Administrator has inspected and approved subgrade.
- .2 Spread topsoil with adequate moisture in uniform layers during dry weather over approved, dry, unfrozen subgrade, where seeding is indicated.
- .3 Bring topsoil up to finished grade.
- .4 Remove stones, roots, grass, weeds, construction materials, debris and foreign non-organic objects from topsoil.
- .5 Manually spread topsoil around trees, plants, surface utilities and other obstacles.

3.4 Soil Amendments

- .1 If required, apply lime, sulphur or other soil amendment at rate determined from soil sample test.

- .2 Mix soil amendment well into full depths of topsoil by cultivating.

3.5 Finish Grading

- .1 Fine grade entire topsoiled area to contours and elevations as indicated or as directed. Eliminate rough spots and low areas to ensure positive drainage.
- .2 Roll topsoil with 50 kg roller, minimum 900 mm wide, to compact and retain surface.
- .3 Leave surface smooth, uniform, firm against deep foot printing, with fine loose texture.

3.6 Surplus Material

- .1 Dispose of surplus topsoil not required for fine grading/landscaping off site.

END OF SECTION

PART 1 – GENERAL

- 1.1 Related Works
.1 01 33 00 – Shop Drawings, Product Data and Samples
.2 32 91 21.01 - Topsoil and Finish Grading

PART 2 – PRODUCTS

2.1 MATERIALS

- .1 Seed:
- .1 [REDACTED] as supplied by [REDACTED] or approved equal.
Contact info: [REDACTED]
(Sowing rate of 15,0 g/m²)
* add additional Lolium Multiflorum nurse crop to mix (Sowing rate of 3 g/m²)
- .2 [REDACTED] as supplied by [REDACTED] or approved equal.
Contact info: [REDACTED]
(Sowing rate of 25,0 g/m²)
- .3 [REDACTED] as supplied by [REDACTED] or approved equal. Contact info: [REDACTED]
(Sowing rate of 4,0 g/m²)
* add additional Lolium Multiflorum nurse crop to mix (Sowing rate of 3 g/m²)
- .4 [REDACTED] as supplied by [REDACTED] or approved equal. Contact info: [REDACTED]
(Sowing rate of 7 g/m²)
- .5 **Type 1- cool custom seed mix**
- | | |
|------------------------|-------|
| Agastache foeniculum | - 10% |
| Allium cernuum | - 4% |
| Asclepias syriaca | - 5% |
| Asclepias verticillata | - 4% |
| Aster laevis | - 7% |
| Echinacea pallida | - 9% |
| Iris Versicolor | - 5% |
| Liatris Spicata | - 12% |
| Monarda fistulosa | - 5% |
| Physostegia Virginiana | - 2% |
| Tradescantia ohioensis | - 5% |
| Verbena Hastata | - 5% |
- Grasses:
- | | |
|-------------------------|-----|
| Carex pensylvanica | -4% |
| Carex Vulpinoida | -4% |
| Deschampsia flexuosa | -4% |
| Elymus Canadensis | -5% |
| Lolium multiflorum | -8% |
| Schizachyrium scoparium | -2% |
- (Sowing rate to be determined by supplier)
* add additional Lolium Multiflorum nurse crop to mix (Sowing rate of 3 g/m²)
- .6 **Type 2- warm custom seed mix**
- Perennials:
- | | |
|----------------------|-----|
| Achillea millefolium | -8% |
| Asclepias tuberosa | -5% |

Coreopsis lanceolate	-5%
Echinacea paradoxa	-7%
Penstemon digitalis	-10%
Rudbeckia hirta	-9%
Rudbeckia triloba	-5%
Solidago Canadensis	-5%
Thalictrum dasycarpum	-6%

Grasses:

Calamagrostis Canadensis	-7%
Carex muskingumensis	-9%
Deschampsia cespitosa	-3%
Deschampsia flexuosa	-5%
Lolium multiflorum	-8%
Sorghastrum nutans	-4%
Sporobolus heterolepis	-4%

(Sowing rate to be determined by supplier)

* add additional Lolium Multiflorum nurse crop to mix (Sowing rate of 3 g/m²)

.7 Mown lawn

55% *Festuca rubra*
30% *Poa pratensis*
15% *Lolium perenne*

(Sowing rate to be determined by supplier)

- .2 Packages will be individually labeled in accordance with 'Seeds Regulations' and indicate clearly the name of the supplier, species, content, grade and mass.
- .3 Use appropriate agriculture broadcast or no till planter seeder and mulching equipment. The Contract Administrator to approve all proposed products and equipment for the work. Ensure soil cover over all new seeds.

2.2 WATER

- .1 Free of impurities that would inhibit germination and growth.
- .2 Water must be supplied from a designated source.

2.3 CELLULOSE-BASED MULCH (PAPER MULCH)

- .1 Use only cellulose-based mulch if seeds were broadcasted to ensure moisture retention during germination. Do not use a tackifier since wildflower seeds can't penetrate through.

PART 3 - EXECUTION

3.1 WORKMANSHIP

- .1 Do not perform work under adverse field conditions as determined by the NCC Representative.
- .2 Additional care shall be taken when seeding adjacent to watercourses or paved area to ensure that seed does not spread or blown onto those areas.

3.2 PERMANENT COVER

- .1 Seeding shall not be carried out under adverse conditions, of high wind, frozen ground or ground covered with snow, ice or standing water.
- .2 Sowing shall be done during the following periods:
 1. Between May 15 and June 15th;
 2. Between September 1st and October 15. (Preferable)
 3. Dormant seeding after November 1st when daytime temperatures are consistently below 5oC.

3.3 SEED BED PREPARATION ON DISTURBED SOIL OR NEW CONSTRUCTION SITE

- .1 Mow existing weeds as low as possible and disposed off-site.
- .2 Remove and dispose of all debris, stones 50 mm in diameter and larger, soil contaminated by oil, gasoline and other deleterious materials off-site.
- .3 Aerate all compacted soil due to construction traffic.
- .4 Add 50mm of live mulch (as supplied by [REDACTED] or approved equivalent) and till in top 200mm of existing soil.
- .5 Do not carry out seed bed preparation more than 1 calendar day before the seeding operation so the Contractor shall avoid run-off problems.
- .6 Surface preparation will produce a soil surface that is predominantly fine in nature (particle sizes of 5 to 10 mm), with no more than five lumps measuring between 10-25 mm in diameter in any 1m² area, and no lumps larger than 25 mm.

SEED BED PREPARATION UNDER EXISTING TREES

- .1 Mow existing grass as low as possible and dispose off-site.
- .2 Remove and dispose of all debris, stones 50 mm in diameter and larger, soil contaminated by oil, gasoline and other deleterious materials off-site.
- .3 Add 50mm of [REDACTED] soil (as supplied by [REDACTED] or approved equivalent) and spread by hand under protected root zone. Ensure mulch doesn't touch trunk at any time
- .4 Do not carry out seed bed preparation more than 1 calendar day before the seeding operation so the Contractor shall avoid run-off problems.
- .5 Surface preparation will produce a soil surface that is predominantly fine in nature (particle sizes of 5 to 10 mm), with no more than five lumps measuring between 10-25 mm in diameter in any 1m² area, and no lumps larger than 25 mm.

SEED BED PREPARATION IN UNDISTURBED GRASS AREAS

- .1 Mow existing grass as low as possible. and disposed off-site.
- .2 Remove and dispose of all debris, stones 50 mm in diameter and larger, soil contaminated by oil, gasoline and other deleterious materials off-site.
- .3 Remove the top 75mm of existing grass and soil with a sod cutter off-site.
- .4 Add 50mm of live mulch (as supplied by [REDACTED] or approved equivalent) and till in top 200mm of existing soil.
- .5 Do not carry out seed bed preparation more than 1 calendar day before the seeding operation so the Contractor shall avoid run-off problems.
- .6 Surface preparation will produce a soil surface that is predominantly fine in nature (particle sizes of 5 to 10 mm), with no more than five lumps measuring between 10-25 mm in diameter in any 1m² area, and no lumps larger than 25 mm.

3.4 HYDROSEEDING (HYDRAULIC SEEDING)

- .1 This application method will **NOT** be accepted for any of the seeding within this contract. It does not ensure firm seed to soil contact and prevents seed stratification to happen which will lead the seed to germinate at the wrong time of the year.

3.5 MECHANICAL PLANTERS

- .1 Use appropriate agriculture broadcast or no till planter seeder. Specific models that can successfully plant native grasses and flowers include the Tye drill, Truax drill, John Deere Rangeland drill, and properly outfitted Brillion seeders.
- .2 Ensure soil cover over all new seeds.
- .3 Roll the seeded area after planting. This step is very important for germination success
- .4 The Contract Administrator to approve all proposed products and equipment for the work.
- .5 Sowing rate to be followed and never increased as it will result in a dominant grass meadow rather than flower meadow where indicated.

3.6 CELLULOSE-BASED MULCH (PAPER MULCH)

- .1 All bare soil areas shall be stabilized with paper mulch immediately after seeding.
- .2 The Contract Administrator to approve all proposed products and equipment for the work.

3.7 MAINTENANCE DURING ESTABLISHMENT AND 2 YEAR WARRANTY PERIOD

Establishment:

- .1 Water seeded areas to maintain optimum soil moisture level for germination and continued growth of grass. Control watering to prevent washouts.
- .2 Gully formations and washouts as a result of rain events greater than 20 mm per day shall be repaired, including regrading and re-seeding.
- .3 Seeded areas shall be accepted by the NCC Representative provided that:
 - .1 seeded areas are properly established;
 - .2 seeded areas are free of weeds and bare or dead spots;
 - .3 no surface soil is visible when grass has been cut to a height of 50 mm;
(mown lawn only)
 - .4 seeded areas have been cut minimum 2 times, the second cut within 24 hours prior to acceptance.
- .4 Areas seeded in fall will be accepted the following spring, one month after the beginning of the growing season, provided the acceptance conditions are met.
- .5 The Contractor shall maintain the seeded areas including mowing until acceptance by the NCC Representative. Unacceptable areas shall be reseeded.
- .6 Weed control:
 - .1 Do not pull weeds at any time. Mowing or hand cutting will be accepted.

First year of maintenance:

- .1 Weed control:
 - a. Mow weeds when they reach a maximum height of at 200-250mm height on a regular basis to prevent them from self-seeding throughout 1st growing season.
 - b. A flail-type mower works best, as it chops up the weeds so they can dry out rapidly. Rotary mowers and sickle bar mowers will not be accepted.

- c. Do not pull weeds at any time due to soil disturbance. Large weeds can be cut by hand if required.
- d. If weeds become thick by mid-summer they should be cut back, along with the nurse crop. If weeds are thin, cut when in bloom, before they set seed.
- e. Do not mow down the year's growth at the end of the season. Leave it to help protect the young plants over the winter. The plant litter and the snow that it catches insulate the soil from rapid changes in soil temperatures, which can cause plant losses due to frost heaving.

Second year of maintenance:

- .1 Weed control:
 - a. Mow the meadow in spring of the second year right to the ground and rake off the cuttings.
 - b. If weeds remain a problem in the second year, mow the meadow in late spring or early summer (before the weeds reach 200-250mm height)
 - c. A flail-type mower works best, as it chops up the weeds so they can dry out rapidly. Rotary mowers and sickle bar mowers will not be accepted.

END OF SECTION

PART 1 GENERAL

1.1 RELATED SECTION

- .1 32 91 21.01 – Topsoil and finish grading
- .2 32 93 12.01 – Plant maintenance and warranty

1.2 SOURCE QUALITY CONTROL

- .1 The Contractor shall commence sourcing the specified material immediately upon award of the Contract.
- .2 Plant materials shall be conformed to species specified in the contract document. All plant materials shall be identified with their complete name and caliper.
- .3 No substitutions will be considered unless the Contractor can demonstrate to the NCC Representative's satisfaction that a prolonged and widespread search for the specified cultivars has been undertaken. The NCC Representative's written approval of plant substitution is required.
- .4 Obtain approval of source of plant material. Acceptance and selection of plant at its source does not prevent rejection on site prior to or after planting operations.
- .5 After harvesting and prior to shipping any plants from the growing nursery, notify the NCC Representative to allow for an inspection of the plants at the growing nursery to assure that all harvesting requirements have been satisfied.

1.3 SHIPMENT AND PRE-PLANTING CARE

- .1 All plants shall be inspected by the Contractor for damage in transit. No defective material shall be delivered to the site. Material subsequently damaged shall be replaced immediately at no additional cost for the NCC.
- .2 Protect plant materials against abrasion, exposure and extreme temperature change during transit.
- .3 Keep roots moist and protected from sun and wind

1.4 STORAGE AND PROTECTION

- .1 Protect plant materials from frost, excessive heat, wind and sun during delivery.
- .2 Immediately store and protect plant material which will not be installed within 1 hour after their arrival on site, in storage locations approved by NCC Representative.
- .3 Protect plant material from damage during transportation
 - .1 When delivery distance is less than 30 km, and vehicle travels at speeds under 80 km/h, tie tarpaulins around plants or over vehicle box.
 - .2 When delivery distance exceeds 30 km or vehicle travels at speeds over 80 km/h, use enclosed vehicle where practical.

- .3 Protect foliage and root balls using anti-desiccants and tarpaulins, where use of enclosed vehicle is impractical due to size and weight of plant material.
- .4 Protect stored plant material from frost, wind and sun and as follows:
 - .1 For pots and containers, maintain moisture level in containers.
 - .3 For balled and burlapped, and wire basket root balls, place to protect branches from damage. Maintain moisture level in root zones.

PART 2 PRODUCTS

2.1 PLANT MATERIALS

- .1 Comply with Guide Specification for Nursery Stock, latest edition, of Canadian Nursery Trades Association referring to size and development of plant material and root ball.
- .2 All plant material to come from a commercial nurseries. The plant material shall be grown in zone 4b or 5a, according to the hardiness zones for plants in Canada established by Agriculture Canada.
- .3 Use plants with strong fibrous root systems free of disease, insects, defects or injuries and structurally sound. Plants must have been root pruned regularly, but not later than one growing season prior to arrival on site.
- .4 Substitution to plant material as indicated on planting plan are not permitted unless written approval has been obtained as to type, variety and size.
- .5 Size indicated are the minimum allowable after pruning.

2.2 WATER

- .1 Free of impurities that would inhibit plant growth.

2.3 MYCORRHIZE INOCULANTS

- .1 Apply mycorrhize inoculants [REDACTED] of [REDACTED] [REDACTED], following application instructions, or an equivalent approved by the NCC and registered in Canada;

2.4 STAKES

- .1 No staking required

2.5 GUYING COLLAR

- .1 N/A

2.6 TREE TRUNK PROTECTION

- .1 'Surtronic' fine mesh trunk wraps as supplied by Dendrotik or approved equal.

2.7 MULCH

- .1 [REDACTED] Composted Pine Mulch as supplied by [REDACTED] or approved equal. Submit sample and name of supplier five (5) days in advance and obtain approval by NCC representative prior to shipping to site.

2.8 GROWING MEDIUM

Growing medium according to section 32 91 21.01 – Topsoil and finish grading

2.9 ANTI-DESICCANT

- .1 Wax-like emulsion to provide film over plant surfaces reducing evaporation but permeable enough to permit transpiration.

2.10 BONEMEAL

- .1 Bonemeal: raw bonemeal, finely ground (minimum analysis of 4% nitrogen and 20% phosphoric acid) to be added at the bottom of each tree and shrub planting hole as per manufacturer recommendations. Mix bonemeal thoroughly with soil.

PART 3 EXECUTION

3.1 PRE-PLANTING PREPARATION

- .1 Delivered plant material to be inspected and approved NCC Representative.
- .2 NCC Representative to approve layout mockup of plant material for all beds until advised differently. Planting bed grades will also need to be approved before planting.

3.2 PLANTING TIME

- .1 Plant materials shall be planted from May 15 to June 30 or from August 15 to October 1, unless otherwise approved by the NCC Representative
- .2 The Contractor shall arrange for all plant species recommended for spring only digging, to be dug and containerized in the spring, immediately upon award of the Contract.
- .3 The foliage of deciduous trees which have broken buds shall be sprayed with anti-desiccant to slow down transpiration prior to transplanting.

3.3 EXCAVATION

- .1 Excavate planting holes to width and depth as indicated on drawings.
- .2 The sides of the planting hole shall be scarified so that water and roots can readily penetrate.

- .3 Place mycorrhize inoculants and bonemeal in the bottom of each plant hole as per manufacturer recommendation.

3.4 PLANTING

- .1 Planting trees and shrubs vertically in the places indicated, oriented in a manner to produce the best possible visual effect with the surrounding structures such as buildings, roads and sidewalks.
- .2 For burlapped root balls, cut away top one third of wrapping and wire basket without damaging root ball. Do not pull burlap or rope from under root ball.
- .3 For container stocks or root balls in non-degradable wrapping, remove entire container or wrapping without damaging root ball.
- .4 Place plant material at a depth similar to depth in nursery.
- .5 Backfill with existing soil in 150 mm layers. Tamp each layer to eliminate air pockets. When two thirds of depth of planting pit has been backfilled, fill remaining space with water. After water has penetrated into soil, backfill to finish grade. Form watering saucer as indicated.
- .6 Water plant material thoroughly.
- .7 After soil settlement has occurred, fill with soil to finish grade.
- .8 Spread 75mm of mulch over all areas of bare soil. Mulch heavily contaminated with soil is not acceptable. Diameter of 400mm around all plant material.
- .9 Remove dead and injured branches and branches that rub causing damage to bark.
- .10 Dispose of burlap, wire and container material off site.

3.5 TRUNK PROTECTION

- .1 Install fine mesh trunk wraps on deciduous trees as indicated.

3.6 TREE SUPPORTS

- .1 No staking required

3.7 PROTECTION DURING CONSTRUCTION

- .1 The Contractor shall protect all work and materials from damage due to planting operations; operations by other Contractors; or trespassers. Maintain protection during installation until acceptance. Treat, repair or replace damaged work immediately.
- .2 Damage done to any of the work by the Contractor, or any of their sub-contractors, shall be replaced by the Contractor at their own expense.

3.8 MAINTENANCE PRIOR TO FINAL INSPECTION

- .1 Perform following maintenance operations from time of planting until the project has been approved by the NCC Representative and the interim certificate of Approval has been issued at Substantial Performance.
 - .1 Water to maintain soil moisture conditions, for optimum establishment, growth and health of plant material without causing erosion.
 - .2 **Structural pruning by a certified arborist must be completed once a year and arborist must provide report to NCC representative.**
 - .3 If acceptance is delayed due to a drawn out schedule by the Contractor, the Contractor shall be responsible for the scope of maintenance outlined in section 32 93 12.01 until final acceptance of the site. The Contractor shall still be responsible for the full term of the warranty as of the date of approval.

3.9 FINAL INSPECTION

- .1 At final inspection, plant material shall be acceptable when it is properly installed, unbroken, shows adequate formation of buds and is free from blight of any description. All planting areas shall be free of weeds, litter and in good order.

END OF SECTION

PART 1 - GENERAL

1.1 RELATED WORKS

- .1 Trees and shrub planting Section 32 93 10.01

1.2.1 WARRANTY

- .1 All plant material shall be warranted for a period of two years from the date of substantial performance.
- .2 The warranty shall cover any defects in materials and workmanship.
- .3 A warranty inspection shall be carried out at the end of the warranty period.
- .4 Extend 2 year warranty on all replacement of plant material.

1.3 DURATION

- .1 Plant material maintenance shall begin immediately after each portion of planting has been completed and shall continue throughout the maintenance and warranty period to the satisfaction of the NCC Representative.

PART 2 - PRODUCTS

2.1 MATERIALS

- .1 Water: shall be free from any contaminants which could adversely affect plant growth.
- .2 Pruning Tools: shall be designed specifically for horticultural purposes and shall be clean, sharp and in proper, safe, working order. Pruning equipment shall be capable of producing clean, flush cuts without tearing or fraying the bark.

PART 3 - EXECUTION

3.1 OPERATIONAL CONSTRAINTS

- .1 Do each maintenance operation continuously and complete within a reasonable time period.
- .2 No maintenance equipment, materials or other miscellaneous items may be stored on site.
- .3 All debris, waste and other extraneous material resulting from the maintenance operation shall be removed from the site daily upon completion of maintenance.
- .4 The Contractor shall be fully acquainted with all relevant Provincial and Municipal By-laws and Regulatory Codes relating to the work of this contract, and will be required to comply with such by-laws and codes without extra compensation.
- .5 Notify the NCC Representative immediately of damage incurred by pest, disease, mechanical or vandalism.

3.2 INTERIM REPLACEMENT OF PLANT MATERIAL

- .1 Throughout the maintenance and warranty period, units of plant material that are found to be unacceptable will be replaced by the Contractor. Any unacceptable material must be replaced within one month unless otherwise directed by the NCC representative. Weekly inspections must be reported for the first growing season.
- .2 At the discretion of the NCC Representative, plant material that is identified as dead or in a poor or diseased condition shall be immediately removed from the site.

3.3 WATERING

- .1 The Contractor is responsible for interim manual watering of all plant material, from time of planting until the end of the warranty period (24 MONTHS).
- .2 Water all plant material immediately after installation. Thereafter,
 - .1 Water daily for the first week after planting;
 - .2 Water every second day for the next 3 weeks;
- .3 For the first warranty year;
 - .1 The contractor shall submit for approval a watering schedule at the beginning of the warranty period. The watering shall occur at least once a week, on Thursday, Wednesday or Tuesday. Once the day is chosen, the watering shall happen each week at the same day.
 - .2 Provide all water required to keep soil within and around the root and in the soil at optimum moisture content between 10 and 20% as measured using a General Digital Moisture Meter.
 - .3 Proceed to watering with a slow water spray jet oriented toward the growing media.
 - .4 The watering shall be made before 11h am or after 14h30 pm to avoid full sun period. Watering should also be avoided during peak use period between 7-9am, 12-1pm and 3-5pm.
 - .5 Proceed to the watering even on rainy days unless receiving written notice of the NCC representative.
 - .6 Hose bibs are available on site, see plans.
- .4 For the remainder of the warranty period, thoroughly water whenever natural precipitation falls below 20 mm per week (Sunday to Saturday) for 2 consecutive weeks. Precipitation data shall be as per Environment Canada from the Macdonald-Cartier Airport weather station.
- .5 Ensure the root zone is thoroughly saturated during each watering operation.
- .6 Repair any damage caused by watering operations.

3.4 WEEDING

- .1 All weeds, dead plants, leaves, branches, paper and other refuse within planting beds shall be removed by hand and disposed of off the Contract site.
- .2 Weeds shall not exceed 5 cm in height between weeding's.
- .3 Ensure the entire root system of weeds is removed and not just the above ground growth.
- .4 At a minimum, weeding shall occur:
 - .1 Weekly from June 1 to August 15;
 - .2 Every two weeks from May 1 to May 31, and from August 16 to October 31.
 - .3 A final weeding shall be completed immediately prior to the final warranty inspection.
- .5 The application of herbicides or mechanical weed removers is prohibited.
- .6 Ensure planting beds are weed free prior to the application of mulch material.
- .7 The scope of work also includes weeding of joints between pavers and between curbs.

3.5 PRUNING

- .1 Prune off dead and injured branches in accordance with accepted arboricultural practices.

3.6 GARBAGE REMOVAL

- .1 Keep planting beds free of garbage and other foreign debris. Remove garbage off-site.

3.7 PEST MANAGEMENT

- .1 Monitor plant material throughout the warranty period for any sign of disease or insect problems. Practice integrated pest management.
- .2 The use of pesticides shall not be permitted.

3.8 WINTER PREPARATION

- .1 In the fall of each warranty year, the Contractor is responsible for completion of the following:
 - .1 Ensure all plant material is watered before freeze-up.

3.9 SPRING PREPARATION

- .1 In late spring of each warranty year, after the soil has thawed and dried up, re-apply mulch over all thin or bare areas to ensure good weed suppression. Mulch thicknesses shall be in accordance with Section 32 93 10.01, Trees and shrubs planting. Ensure new growth is not suppressed by the application of mulch material. Ensure mulch is neat and tidy with clean edges.

3.10 INCIDENTAL MAINTENANCE

- .1 The Contractor shall, in general, be responsible for any incidental maintenance to ensure healthy plant growth and a satisfactory appearance of plant material.

3.11 REINSTATEMENT

- .1 Any damage to vegetation, hard surfaces, structures or services caused as a result of the Contractor's work methods and practices for plant material maintenance shall be reinstated or repaired to the satisfaction of the NCC Representative. The cost of such reinstatement or repair shall be solely at the Contractor's expense.

3.12 FINAL WARRANTY INSPECTION

- .1 A one-time inspection of all plant material shall be carried out by the NCC Representative upon completion of the maintenance and warranty period.
- .2 Plant material shall be **acceptable** when it is undamaged, shows adequate growth and formation of buds, and is free from blight of any description. All planting beds and tree pits shall be free of weeds, litter and in good order, including the removal of all tree supports.
- .3 Plant material shall be **unacceptable** when it does not meet this quality standard.
- .4 Units of plant material that are found to be unacceptable will be replaced by the Contractor at the earliest opportunity. The NCC Representative reserves the right to extend the Contractor's maintenance and warranty responsibilities for an additional one-year for replacement plant material.
- .5 In the event that this inspection is satisfactory to the NCC Representative, and that there are no outstanding commitments to the contracted works, the Contractor will be given final approval of the maintenance and warranty requirements.
- .6 Where, in the opinion of the NCC Representative, the Contractor has failed to complete obligations as detailed in this Specification; and further, fails to rectify said deficiency within two days of written notification from the NCC Representative, the NCC Representative reserves the right to retain others to complete the work and deduct incurred expenses from monies owing to the Contractor.

END OF SECTION

PART 1 – GENERAL

- 1.1 Related Work Specified Elsewhere
- .1 Clearing and Grubbing Section 31 11 00
- 1.2 References
- .1 Ontario Ministry of Agriculture and Food
.1 Pruning Ornamentals - 1992.
- 1.3 Qualifications
- .1 Pruning shall be carried out by a certified arborist, as designated by the ISA. Please provide ISA # and name of arborist to NCC representative prior to commencement of work.
- 1.4 Field Sample
- .1 Do sample pruning acceptable to Contract Administrator to identify:
.1 Knowledge of target areas including branch bark ridge and branch collars.
.2 Technique for selection process and pruning used to establish desired form and shape for each species.
- .2 Acceptance of work will be determined by Contract Administrator from field sample.

PART 2 - PRODUCTS

- 2.1 Pruning Equipment
- .1 All pruning or cutting equipment shall be designed specifically for tree work and shall be clean, sharp, and in proper safe, working order. Pruning equipment shall be capable of producing clean, flush cuts without tearing or fraying the bark.
- 2.2 Disinfectant
- .1 20% solution of sodium hypochlorite or 70% solution of ethyl alcohol.

PART 3 - EXECUTION

- 3.1 General
- .1 Prune in accordance with Pruning Ornamentals, and as directed by Contract Administrator. Where discrepancies occur between standard and specifications, specifications govern.
- .2 Tool maintenance:
.1 Ensure that tools are clean and sharp throughout pruning operation. Do not use tools which crush or tear bark.
.2 Disinfect tools before each tree is pruned.
.3 On diseased plant material disinfect tools before each cut.
- .3 Notify immediately Contract Administrator of conditions detrimental to health of plant material or operations.

- .4 Prune during plant dormant period or after leaves have matured. Avoid pruning during leaf formation, at time of leaf fall, or when seasonal temperature drops below minus 10°C.
- .5 Retain natural form and shape of plant species.
- .6 Do not:
 - .1 Flush cut branches.
 - .2 Crush or tear bark.
 - .3 Cut behind branch bark ridge.
 - .4 Damage branch collars.
 - .5 Damage branches to remain.
- 3.2 Safety Pruning
 - .1 Remove dead, dying, diseased and weak growth from plant material designated by Contract Administrator in order to promote healthy growth and the safety of pathway users.
 - .2 Remove loose branches, twigs and other debris lodged in tree.
 - .3 For branches under 50 mm in diameter:
 - .1 Locate branch bark ridge and make cuts smooth and flush with outer edge of branch collar to ensure retention of branch collar. Cut target area to bottom of branch collar at an angle equal to that formed by line opposite to branch bark ridge.
 - .2 Make cuts on dead branches smooth and flush with swollen callus collar. Do not injure or remove callus collar.
 - .3 Do not cut lead branches unless directed by Contract Administrator.
 - .4 For branches greater than 50 mm in diameter:
 - .1 Make first cut on lower side of branch 300mm from trunk, one third diameter of branch.
 - .2 Make second cut on upper side of branch 500mm from trunk until branch falls off.
 - .3 Make final cut adjacent to and outside branch collar.
 - .5 Ensure that trunk bark and branch collar are not damaged or torn during limb removal. Repair areas which are damaged, or remove damaged area back to next branch collar.
- 3.3 Structural Pruning
 - .1 Follow: ISA ANSI A300 pruning standard - part 1
- 3.4 Care of Wounds
 - .1 Shape bark around wound to an oblong configuration ensuring minimal increase in wound size. Retain peninsulas of existing live bark.
- 3.5 Clean-Up
 - .1 Collect and dispose of pruned material daily and remove from site.
 - .2 Dispose of woody material in accordance with Section 31 11 00, Clearing and Grubbing.

END OF SECTION