

1. PLANTINGS AS SHOWN IN REINSTATEMENT DRAWING AND PLANTING DETAILS

FOR REVIEW ONLY
NOT FOR CONSTRUCTION

RUISSEAU PARK
RAVINE REHAB



TYPICAL SECTIONS & DETAILS

Contract No. CP000772 Dwg. No. 01

Sheet 2 of 4

Carina Duclos, P.Eng.
Director

Marc Tremblay, C.E.T.
Sr. Project Manager

McINTOSH PERRY

115 Walgreen Road, RR 3
Carp, ON K6A 1J0
Tel: 613-836-2184 Fax: 613-836-3742
www.mcintoshperry.com

Asset No.

Asset Group

Des. MV Chk'd. INITIALS

Dwn. MV Chk'd. INITIALS

Utility Circ. No. Index No.

CTY:XXXXX

Const. Inspector NAME:

Scale: N.T.S.

NOTE: The location of utilities is approximate only, the exact location should be determined by consulting the municipal authorities and utility companies concerned. The contractor shall prove the location of utilities and shall be responsible for adequate protection from damage.

No.	Description	By	Date (dd/mm/yyyy)
1	ISSUED FOR PUBLIC CIRCULATION	MV	21/07/2023

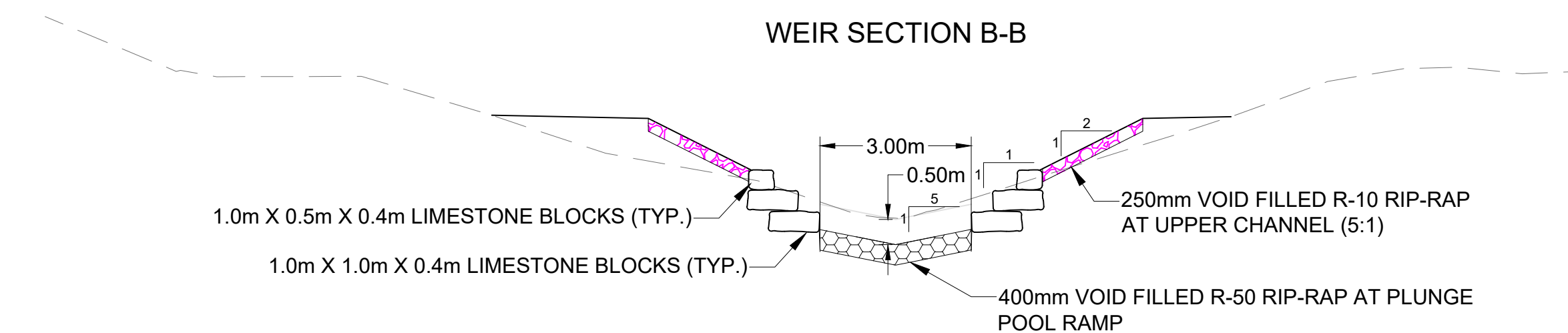
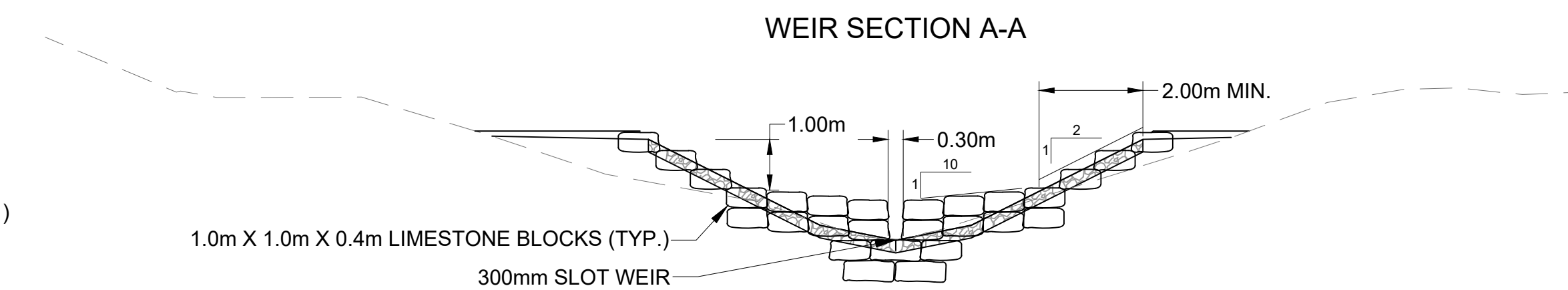
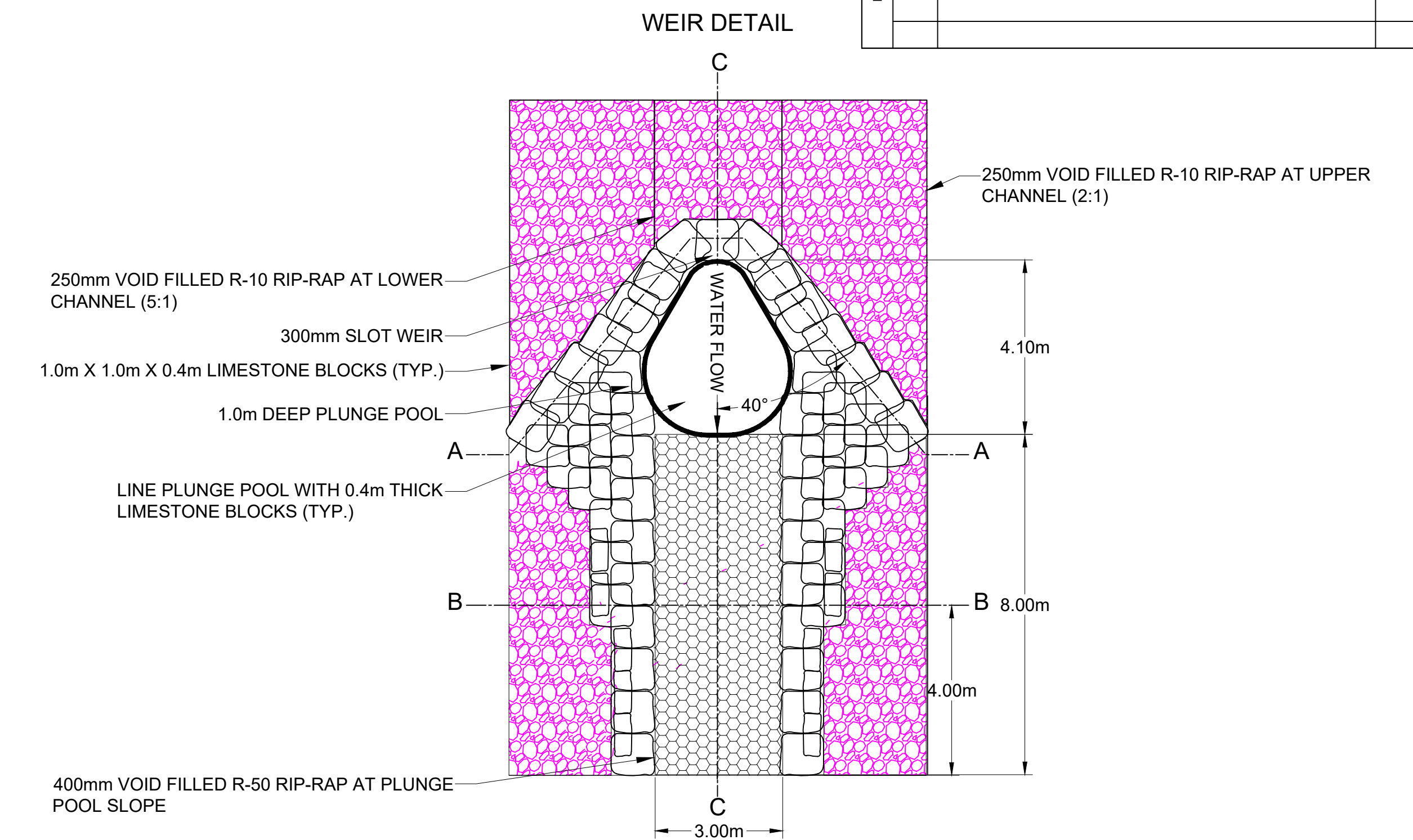
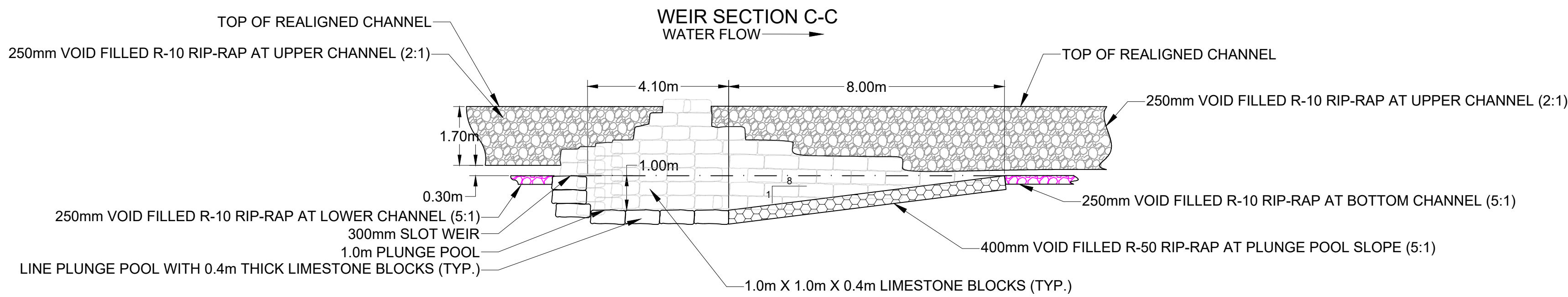
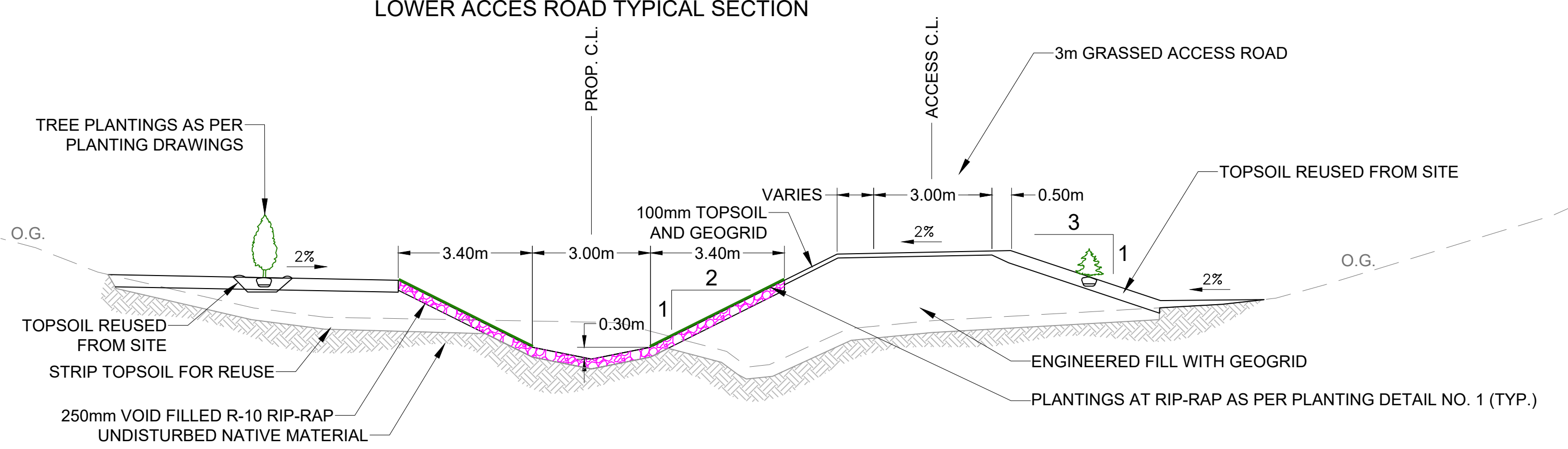
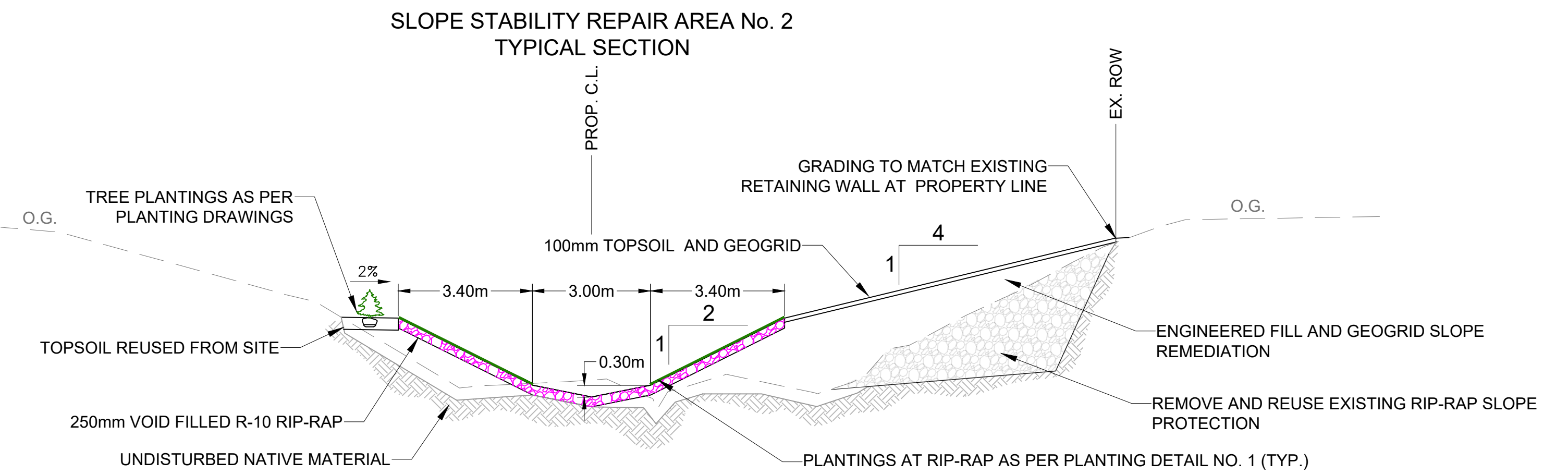
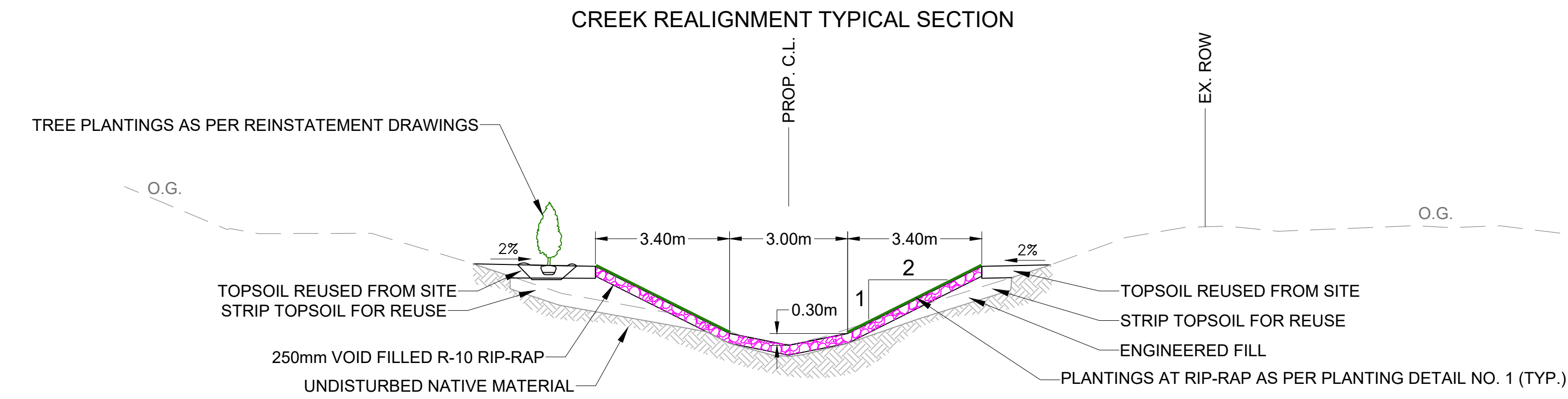

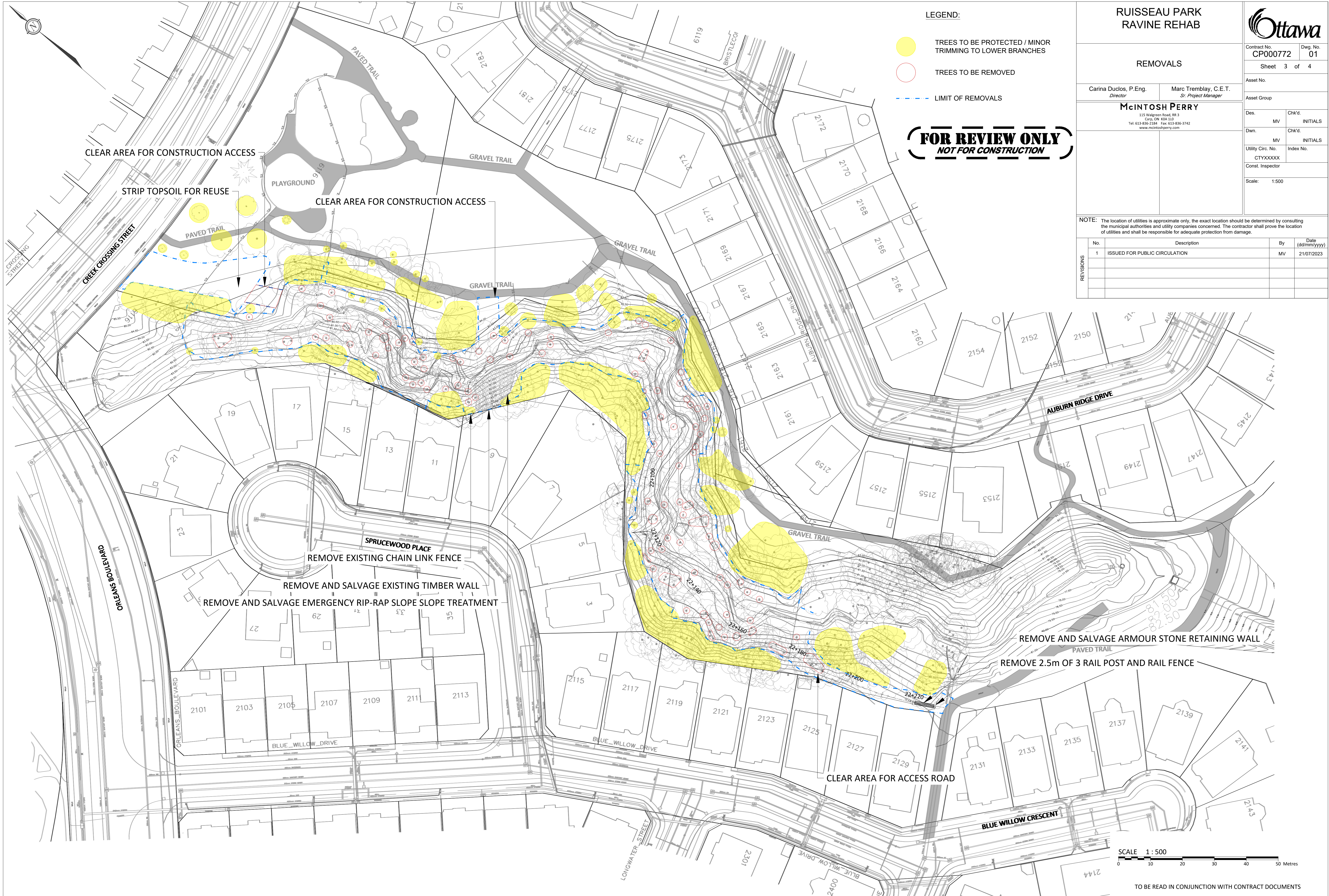

LEGEND:

- TREES TO BE PROTECTED / MINOR TRIMMING TO LOWER BRANCHES
- TREES TO BE REMOVED
- - - LIMIT OF REMOVALS

FOR REVIEW ONLY
NOT FOR CONSTRUCTION

**RUISSAU PARK
RAVINE REHAB**

REMOVALS

Contract No. CP000772 Dwg. No. 01
Sheet 3 of 4

Asset No.
Asset Group

Carina Duclos, P.Eng. Director
Marc Tremblay, C.E.T. Sr. Project Manager

McINTOSH PERRY
115 Walgreen Road, RR 3
Carrville, ON N0B 1J0
Tel: 613-836-2184 Fax: 613-836-3742
www.mcintoshperry.com

Des.	MV	Chk'd.	INITIALS
Dwn.	MV	Chk'd.	INITIALS
Utility Circ. No.	CTYXXXXX	Index No.	
Const. Inspector			
Scale:	1:500		



Contract No. CP000772 Dwg. No. 01

Sheet 3 of 4

Asset No.
Asset Group

Des. MV Chk'd. INITIALS

Dwn. MV Chk'd. INITIALS

Utility Circ. No. CTYXXXXX Index No.

Const. Inspector

Scale: 1:500

NOTE: The location of utilities is approximate only, the exact location should be determined by consulting the municipal authorities and utility companies concerned. The contractor shall prove the location of utilities and shall be responsible for adequate protection from damage.

No.	Description	By	Date (dd/mm/yyyy)
1	ISSUED FOR PUBLIC CIRCULATION	MV	21/07/2023

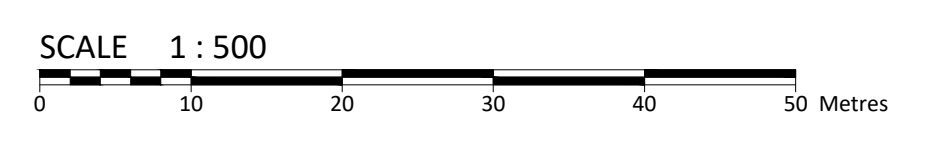





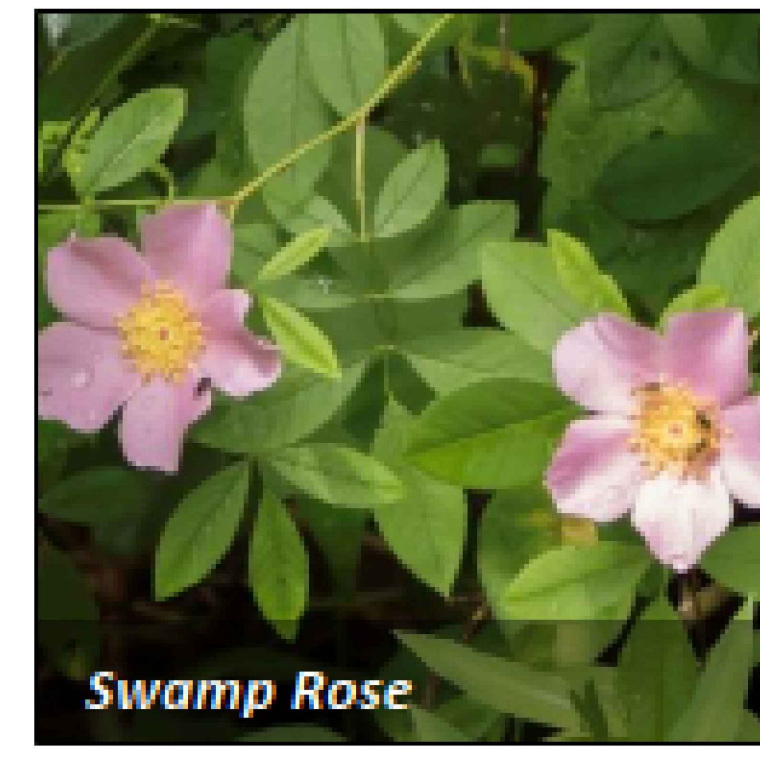

TO BE READ IN CONJUNCTION WITH CONTRACT DOCUMENTS

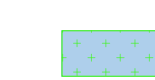
SHRUB PLANTING AT VOID FILLED RIP-RAP SPECIES



LEGEND:

-  SHRUB / POLE PLANTINGS WETLAND SEEDING MIX AT LOWER CHANNEL
-  SEEDING
-  SEEDING WITH TERRASLOPE GEOGRID
-  SHRUB PLANTINGS AND SEED MIX AT UPPER CHANNEL
-  CONIFEROUS TREE PLANTING
-  DECIDUOUS TREE PLANTING
-  SHRUB PLANTING

RUISSEAU PARK RAVINE REHAB



Contract No. CP000772 Dwg. No. 01

PLANTINGS

Carina Duclos, P.Eng. Director
Marc Tremblay, C.E.T. Sr. Project Manager

McINTOSH PERRY

115 Walgreen Road, RR 3
Carrville, ON K0M 1J0
Tel: 613-836-2184 Fax: 613-836-3742
www.mcintoshperry.com

Asset No.	Des.	Chk'd.
	MV	INITIALS
Asset Group	Dwn.	Chk'd.
	MV	INITIALS
	Utility Circ. No.	Index No.
	CTYXXXXX	
	Const. Inspector	
	Scale:	1:500

(FOR REVIEW ONLY)
NOT FOR CONSTRUCTION

NOTE: The location of utilities is approximate only, the exact location should be determined by consulting the municipal authorities and utility companies concerned. The contractor shall prove the location of utilities and shall be responsible for adequate protection from damage.

No.	Description	By	Date (dd/mm/yyyy)
1	ISSUED FOR PUBLIC CIRCULATION	MV	21/07/2023

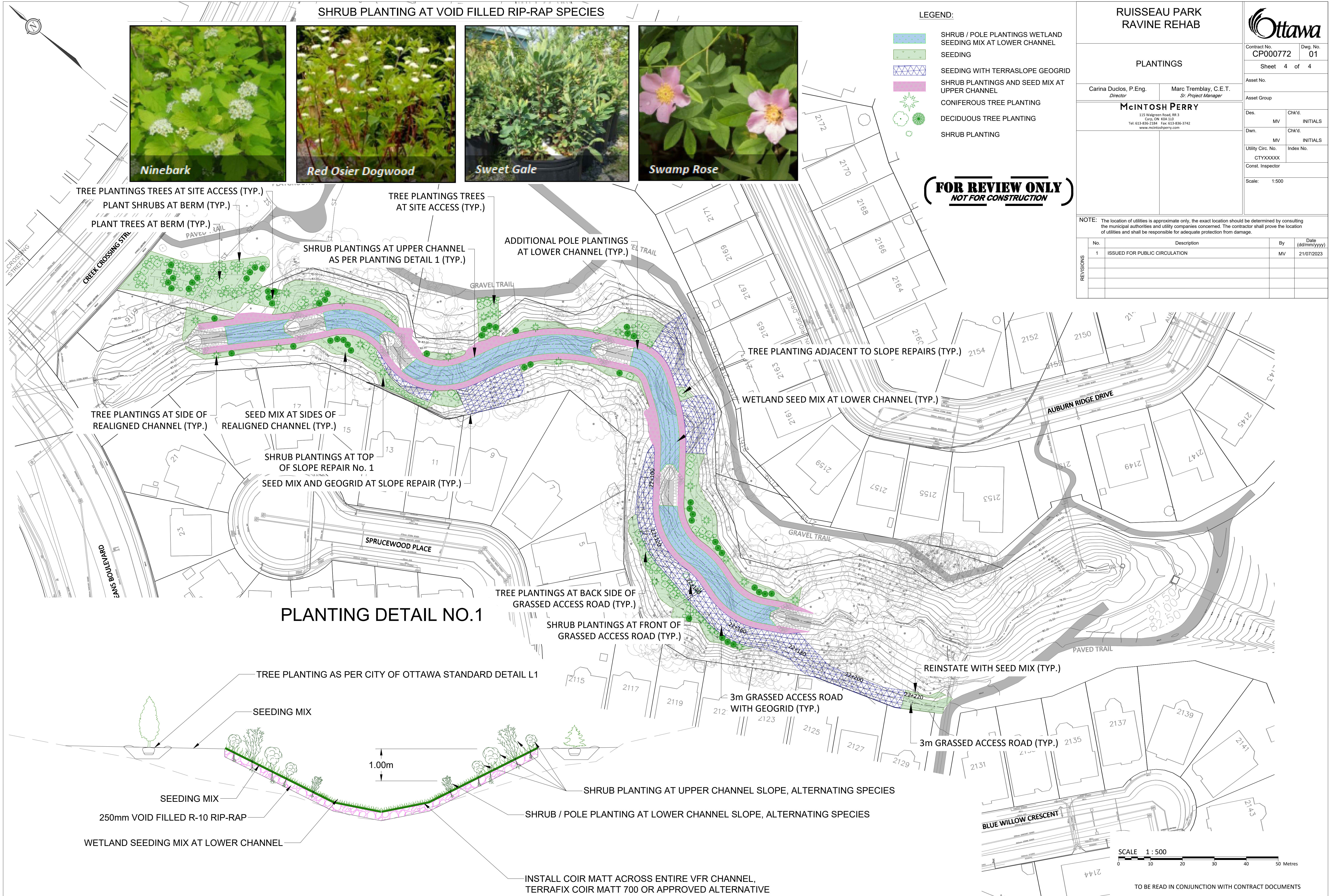

PLANTING DETAIL NO.1

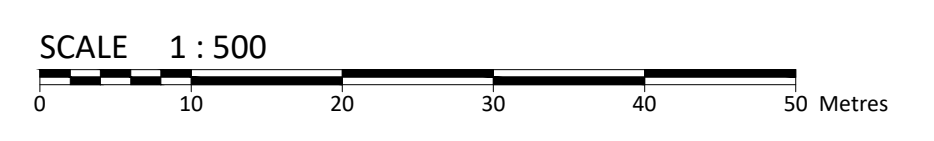

TO BE READ IN CONJUNCTION WITH CONTRACT DOCUMENTS