



# **Ottawa LRT Independent Review Report**

April, 2022  
Confidential

City of Ottawa  
c/o Singleton Urquhart  
Reynolds Vogel LLP  
150 King St West, Suite  
2512  
Toronto, ON  
M5G 1J9

# Ottawa LRT Independent Review Report

April, 2022  
Confidential

### Information class:Standard

This Report has been prepared solely for use by the party which commissioned it (the 'Client') in connection with the captioned project. It should not be used for any other purpose. No person other than the Client or any party who has expressly agreed terms of reliance with us (the 'Recipient(s)') may rely on the content, information or any views expressed in the Report. This Report is confidential and contains proprietary intellectual property and we accept no duty of care, responsibility or liability to any other recipient of this Report. No representation, warranty or undertaking, express or implied, is made and no responsibility or liability is accepted by us to any party other than the Client or any Recipient(s), as to the accuracy or completeness of the information contained in this Report. For the avoidance of doubt this Report does not in any way purport to include any legal, insurance or financial advice or opinion.

We disclaim all and any liability whether arising in tort, contract or otherwise which we might otherwise have to any party other than the Client or the Recipient(s), in respect of this Report, or any information contained in it. We accept no responsibility for any error or omission in the Report which is due to an error or omission in data, information or statements supplied to us by other parties including the Client (the 'Data'). We have not independently verified the Data or otherwise examined it to determine the accuracy, completeness, sufficiency for any purpose or feasibility for any particular outcome including financial.

Forecasts presented in this document were prepared using the Data and the Report is dependent or based on the Data. Inevitably, some of the assumptions used to develop the forecasts will not be realised and unanticipated events and circumstances may occur. Consequently, we do not guarantee or warrant the conclusions contained in the Report as there are likely to be differences between the forecasts and the actual results and those differences may be material. While we consider that the information and opinions given in this Report are sound all parties must rely on their own skill and judgement when making use of it.

Information and opinions are current only as of the date of the Report and we accept no responsibility for updating such information or opinion. It should, therefore, not be assumed that any such information or opinion continues to be accurate subsequent to the date of the Report. Under no circumstances may this Report or any extract or summary thereof be used in connection with any public or private securities offering including any related memorandum or prospectus for any securities offering or stock exchange listing or announcement.

By acceptance of this Report you agree to be bound by this disclaimer. This disclaimer and any issues, disputes or claims arising out of or in connection with it (whether contractual or non-contractual in nature such as claims in tort, from breach of statute or regulation or otherwise) shall be governed by, and construed in accordance with, the laws of Canada and Ontario to the exclusion of all conflict of laws principles and rules. All disputes or claims arising out of or relating to this disclaimer shall be subject to the exclusive jurisdiction of the Canadian and Ontarian courts to which the parties irrevocably submit.

# Contents

Volume 1: Executive Summary and Introduction

Volume 2: Project Co Failure Points

Volume 3: Track and Rail Systems

Volume 4: MSF

Volume 5: Revenue Vehicles

Volume 6: Compiled Recommendations

Volume 7: Appendices



# **Volume 1: Executive Summary and Introduction**

April, 2022  
Confidential

# Contents

|                                  |          |
|----------------------------------|----------|
| <b>Executive summary</b>         | <b>i</b> |
| List of Abbreviations            | vii      |
| <b>1 Introduction</b>            | <b>1</b> |
| 1.1 Background                   | 1        |
| 1.2 Independent Review           | 2        |
| 1.3 Document Review              | 3        |
| 1.4 The Structure of this Report | 4        |
| <br>                             |          |
| <b>Figures</b>                   |          |
| Figure 1.1: Otrain System Map    | 1        |

# Executive summary

Mott MacDonald has been engaged by the City of Ottawa (“City”) to provide Independent Review (“Independent Review”) services regarding the Confederation Line LRT Stage 1 Light Rail Transit project (the “Project”), designed, built, and maintained by the Rideau Transit Group “Project Co.”

The purpose of this report is to summarize Mott MacDonald’s findings regarding the review of the trackwork, OCS, vehicles, rail systems, as well as to provide a summary of recommended changes or repairs or upgrades that are required to improve the performance of the Project systems, and Project Operations and Maintenance. The review included evaluation of the Belfast Road Maintenance Service Facility (“MSF”) and the ability of the MSF’s to operate successfully as the LRV fleet number is increased during Stage 2 of the project, as well as documenting the conditions and potential issues seen in relation to the derailments within the MSF facility and elsewhere.

The City engaged Mott MacDonald through counsel to conduct the Independent Review, which included document review, site visits, and analysis, to assess the conditions and potential issues with the infrastructure, vehicles, systems, and maintenance practices designed, built and/or implemented by Project Co, as well as an analysis of the performance of the system, and a summary of recommended changes, repairs, or upgrades that are required to improve the performance of the system.

To complete the assignment, Mott MacDonald has engaged a team of subject matter experts from around the globe to review and comment on the issues found. The range of specialists has included those engineering disciplines required to address the issues fully, and in providing these opinions, Mott MacDonald has sought to distinguish between:

- Project Agreement (“ PA” )/Project Output Specification requirements; or
- Project Co commitment(s) or requirement(s) from one of their published plans or procedures (if not explicit in the PA); or
- Project Co activity that we do not believe meets “ Good Industry Practice” as required by PA, item 9.2(a)(ii)(D), and defined in PA Schedule 1 “ Definitions” item 1.238.

As part of the Independent Review, Mott MacDonald requested background information from Project Co. Document requests were tracked via a Request for Information (“RFI”) log, which is included as in Volume 7. In many cases, the requests were to provide documentary evidence or proof that a proposed rectification, as proposed by Project Co, has, in fact, been undertaken. At this time, responses to RFIs submitted to Project Co on many of these RFIs remain outstanding, so that Mott MacDonald could not make a conclusive assessment as to the efficacy of the measures implemented, with respect to those issues. In the absence of the documentary evidence, Mott MacDonald has worked to provide our assessment of whether any proposed rectification was likely to mitigate the given issue, though our opinion is subject to change should requested details be provided later.

This report has been prepared for release as requested by the City, as the City desired to inform City Council as to our efforts, and findings, to date, in spite of the fact that Mott MacDonald cannot definitely confirm our findings related to all issues noted, due to the time it has been taking for Mott MacDonald to receive answers to our various RFIs.

## The Structure of this Report

Given the varying nature of the work elements, this report has been divided into seven “Volumes,” as follows:

- Volume 1: Executive Summary and Introduction
- Volume 2: Project Co Failure Points

- Volume 3: Track and Rail Systems
- Volume 4: MSF
- Volume 5: Revenue Vehicles
- Volume 6: Compiled Recommendations
- Volume 7: Compiled Appendices

Each Volume contains a brief summary, technical observations and findings, and detailed recommendations, as appropriate, all related to the work element that is the topic of the Volume. All recommendations for all issues compiled in Volume 6, and Volume 7 contains the compiled Appendices for all of the other Volumes in this report.

This Executive Summary is structured in accordance with the report, and contains high level findings from each Volume.

Please note that any capitalized terms that are not defined in this report are used in the same sense as defined by the Project Agreement.

Please also note that this report has been developed under a privileged and confidential assignment on behalf of the City of Ottawa. While the report has been prepared for release to City Council as requested by the City and City Counsel, neither the City nor City Counsel have agreed to waive privilege over the overall assignment.

## **Volume 2 – Project Co Failure Points**

In its Notice of Default issued on March 10, 2020, the City refers to several clauses of the Project Agreement in relation to Project Co Events of Default. As a technical Independent Reviewer, Mott MacDonald has investigated the circumstances of Project Co Event of Default as they relate to the Failure Points for Aggregate Vehicle Kms Availability and System Events (together referred to as Vehicles Availability Ratios for the purpose of this analysis). Service and Quality Failures have been excluded from the analysis. Mott MacDonald's evaluation of the Vehicles Availability Ratios as it relates to Project Co Failure Points Events of Default is presented in detail in Volume 2 of this report.

Based on the Failure Points incurred prior to the March 10, 2020 the City issued a Notice of Default for Aggregate Vehicles Kms Availability and System Events. Subsequently, there were two derailment incidents in August and September 2021 causing the Failure Points to increase again and again to breach the threshold for Project Co Event of Default. These incidents prompted the City to issue a second Notice of Default on September 24, 2021. Mott MacDonald's calculations determined that that Project Co exceeded the thresholds for a Project Co Event of Default, in respect of both the March 2020 and September 2021 Notices of Default, as illustrated in Volume 2, **Table 2.1**.

Although Volume 2 is focused on the level of Failure Points incurred, it is worth noting that Failure Points do not give the full picture of operational and maintenance issues. Volumes 3 and 5 provide an in-depth review of technical and operational issues, some of which may not have impacted the level of Failure Points incurred to date.

In addition, Project Co likely benefited from lower service requirements since the start of the COVID-19 pandemic. For example, only eight trains were required in the spring 2020, and 11 trains were running in March 2022. However, the technical issues discussed in Volumes 3 and 5 will be under increased tension as it applies to possible negative long-term effects on System performance if maintenance activities continue to be deferred, as ridership increases and more vehicles are required post-COVID-19 pandemic.

## **Volume 3 – Track and Rail Systems**

### **Independent Review – Project Co Rectification Plan**

It is Mott MacDonald's assessment of the Rectification Plan dated March, 2020, proposed by Project Co ("the Rectification Plan") that the changes proposed are considered positive, and if implemented, are likely to improve the reliability of the System in future. However, Project Co has not provided any further

updated status to the implementation of the Rectification Plan, or whether the proposed changes made under the Project Co Rectification Plan have solved the issues as intended.

### *Track Design*

Many of the issues associated with the System's trackwork do not typically manifest immediately as issues which incur Failure Points. Instead, the issues seen are causal to downstream problems which will in themselves become factors in the System's overall performance. Examples of track issues that have been experienced, with the potential to lead to downstream problems, include:

- Track buckles associated with the Rail Neutral Temperature (" RNT" ) potentially resulting in speed restrictions or System stoppages which limit the System's ability to provide the required level of service.
- Track corrugation potentially causing breaches of the System's ride quality and noise and vibration requirements.
- Track corrugation potentially leading to premature deterioration of the condition of the LRVs resulting in increased maintenance or lack of availability for service.

Regarding the issue of RNT, in Volume 3 of this report we have presented a number of short-term measures that could be implemented to address immediate risks, and a number of strategic and longer-term fixes that would result in a more robust track structure, including implementing a proactive maintenance regime, all with the goal to minimize impact on the safe operation of the line.

Corrugation (the periodic wear of the rail surface into peaks and troughs) has been observed to be present by Mott MacDonald and by Project Co on both rails of the tight radius curves on the Confederation Line. This uneven surface results in high forces between rail and wheel that increases the severity of the corrugation and can result in damage to both track and vehicle. Corrugation is unlikely to limit the availability of the vehicles in the short term, but, over extended duration, the vehicles can experience cyclical loading that can introduce fatigue cracks which can impact safety. It is important to note that some bogie mounted equipment and associated mounting brackets/fixings have become detached and fallen off onto the track, including speed sensors, and wheel flange lubrication and sanding equipment, likely due to fatigue failures. In addition, corrugation results in high levels of noise that can be a nuisance to neighbours and to those onboard trains who can also experience lower ride quality.

Rail grinding removes the corrugation of the affected sections. It will reduce the high forces and the potential impact on the track and vehicle as well as arrest the development of defects before they become problematic. Project Co has contracted with a grinding contractor who has undertaken grinding of affected sections of the Confederation Line and also with a consultant to provide expert advice. These grinding programs have taken place but grinding the rail to the original profile will not prevent corrugation from forming in future, and given its previous rapid growth, it is likely to require grinding again. High growth rates of corrugation and frequent grinding would limit the lifespan of the rail.

### *Track Equipment*

Switch Heaters – switches had been observed to freeze during winter, so gas-fired switch heaters were proposed to be installed as part of Project Co's Rectification Plan. At the time of this report, we understand from City of Ottawa representatives that remedial works have been undertaken at the switch heaters, in accordance with Project Co's Rectification Plan. These changes to the heaters and the other proposed mitigations do appear to have improved the situation, but at this time, it is not possible to validate that all of the concerns regarding switch heaters have been addressed.

## **Rail Systems**

### *Overhead Catenary System ("OCS")*

Mott MacDonald carried out an assessment of the proposed modifications of OCS items included within the Rectification Plan proposed by Project Co. As noted above, it is Mott MacDonald's assessment of the Rectification Plan proposed by Project Co that the changes to the Parafil Rope, Rigid Rail and OCS Wire/Pantograph interface proposed are considered positive, and, if implemented, are likely to improve in future.

It must also be noted that the OCS system forms a direct point of contact and interface with the Revenue Vehicles. As such, there is further commentary on the OCS contained in Volume 5 of this report.

During the assessment and site visit several other items relating to the OCS were identified as requiring some maintenance and/or modifications on site, in addition to the actions proposed by Project Co in the Rectification Plan. These included:

- Crossovers and Turnouts – out-of-running contact wires are scraping on pantograph horns due to incorrect profile of contact wire and crossover/turnout cantilever limiting uplift of contact wire.
- Section Insulators – a number of the section insulators are in need of adjustment due to the poor transition of the pantograph.
- Balance Weights – the settings and allowable movement of the weights in balance weight anchor terminations require further assessment as they do not appear to be able accommodate extreme weather conditions.

In addition, a engineering analysis of the jumper wires is required to determine if there is adequate current carrying capacity of the system between the conventional catenary to rigid rail and at crossovers/turnouts.

Other issues were identified during the review of the video recordings of the pantograph/OCS interface before and after the mainline modifications as per the Project Co Rectification Plan, and are discussed in more detail in Volume 3 of this report.

#### *GIDS and SCADA*

Mott MacDonald reviewed the guideway intrusion detection system (“GIDS”) and supervisory control and data acquisition (“SCADA”) system by comparing the original project requirements against the Rectification Plan, incident logs, and typical SCADA system logs.

It appears that both of the GIDS and SCADA systems are in operation and meet technical aspects of the project requirements, noting that there are still instances of “false positives” in the GIDS system, and the SCADA system in its current configuration is providing a large volume of alarms that is causing operational disruption which therefore requires further remedy.

#### *CBTC*

Mott MacDonald reviewed the performance of the CBTC system in light of the Rectification Plan, reliability reports, incident logs, and system User Guides provided.

Analysis of the performance of the CBTC system reveals that the system has experienced various initial issues after operation commenced, but the frequency of these problems has since reduced, and Project Co has provided software updates on an ongoing basis to further improve the performance of the system, which reflects typical practice. The CBTC system is considered to perform as intended.

#### *Traction Power*

Mott MacDonald reviewed the Traction Power systems for the OLRT by comparing the original project requirements against the Rectification Plan, incident logs, SCADA system logs, sub-system design reports and commentary from the City of Ottawa regarding key matters.

The key operational issues (from the Rectification Plan, SCADA system logs, review of design and discussions with the City of Ottawa, as the Operator) understood by Mott MacDonald include:

This report has been developed under a privileged and confidential assignment on behalf of the City of Ottawa. While the report has been prepared for release to City Council as requested by the City and counsel to the City, neither the City nor its' counsel waive privilege for the overall assignment.

- Events generated by the SCADA system and recorded in the events log that indicate excessive operation of TPSS Negative Grounding Devices across the network; high levels of AC and DC tripping of circuit breakers; excess temperature issues in several of the sub-stations; and DC frame leakage (ground fault) alarms over period of February 2020 to April 2021.
- Reporting provided by the City of Ottawa that Enbridge Gas, a network adjacent utility, have experienced/are experiencing elevated levels of stray current from the O-Train.
- Evidence of a specific high priority NCR entry regarding missing stray current baselining data when the System was entered into service.
- Reporting provided by the City of Ottawa of an arcing event on March 5, 2021, at LRV-1117/Parliament Station, which is an indicator of issues with high rail potentials, grounding and bonding issues.

#### **Volume 4 – MSF**

The MSF appears to have been designed and constructed in general accordance with the Project Agreement (“PA”) Schedule 15. However, it should be noted that PA Schedule 15 is structured as an output specification, which is typical of AFP projects, but as such does not include or identify specific requirements for the MSF other than the need for the MSF to be designed, built, and maintained by Project Co and that the MSF is to provide for the maintenance of the systems vehicle fleet.

The maintenance areas appear to be reasonably equipped to perform the running type maintenance for the fleet. There are areas set aside for bench test equipment, welding, purpose build bogie stands, lifting jacks and specialized shunting machines to move the trains within the MSFs if required. Similarly, both MSF1 and MSF2 have areas where the overhead power can be provided to the train and the area isolated from workers not approved to be in that location, and both the MSFs also contain overhead cranes that can be used for lifting and moving equipment around the facility. MSF1 and MSF2 locations had good lighting, end doors in the maintenance building and air ventilation in operation during our visit.

The MSF may have been designed and constructed in general accordance with PA Schedule 15-2 and appears to have the required equipment and facilities to support the required operation for running type maintenance; however, Mott MacDonald has identified several areas of concern as they apply to Good Industry Practice that could be applied to the design and operation of this type of facility. These include:

- Track Condition and Geometry
- Vehicle Storage Shed
- Trackwork Loop
- Movement Constraints
- Miscellaneous Equipment Faults
- Operational Processes
- Asset Management Plan
- Revenue Vehicle Maintenance Processes
- Incidents within the MSF

#### **Volume 5 – Revenue Vehicles**

Revenue service vehicle reliability reports, maintainability and reliability reports, site visits, failure reports, part drawings, and maintenance manuals were reviewed to evaluate the effectiveness of Project Co’s Rectification Plan and their adherence to the PA. This effort was limited by lack of access to some specific information, data, and documentation, requested but not received from Project Co.

From the background review, subsequent site visits, and assessment of information provided to date, Mott MacDonald has identified the following categories of vehicle related issues, arising from our observations, and our review of maintenance practices:

- Deferred Maintenance

- Maintenance Observations
  - Wheel Truing
  - Wheel Flange Lubrication
  - Speed Sensors
  - Wheel Flats
  - Sanding
- Maintenance Practices:
  - Proactive Data Collection
  - LRV Daily Checklist.
  - Mainline Derailments
- Configuration Control and Traceability
- Spares Management

Further, issues with the level of fault reporting and vehicle status information and data being provided, have resulted in the City developing their own methods of collating and analyzing the data.

Our review of the issues with the Revenue Vehicles has raised several issues which left uncorrected, could lead to the further accumulation of Failure Points up to and including the Project Co Event of Default threshold, and which might be further exacerbated once normal Service levels are re-instated, post the COVID-19 pandemic. This is compounded by the apparent disconnect between the reliability reporting methods being used.

## **Volume 6 – Priority Recommendations**

Recommendations arising from the Independent Review are compiled in Volume 6 of this report.

### **Conclusion**

As noted earlier, it is Mott MacDonald's assessment that the changes proposed in Project Co's Rectification Plan will be positive in the context of System reliability. Our report also proposes mitigations to additional issues which we have noted, and that if implemented, are likely to further improve System performance.

In the longer term, we believe that Project Co should adjust their maintenance practices in accordance with good industry practice as defined in other jurisdictions, to gather and track the necessary data to provide traceability and continuity on how often assets have been adjusted, how long they have run, and the magnitude of any adjustments and replacements made. This data should be maintained through the lifecycle of the project and used to apply a proactive approach to maintenance and asset management.



## List of Abbreviations

Below is a summary of the abbreviations used throughout this report.

|       |   |       |  |
|-------|---|-------|--|
| AFP   | Alternate Financing and Procurement                           | MTBF  | Mean Time Between Failures               |
| AMP   | Asset Management Plan   | NGD   | Negative Grounding Device                |
| APS   | Auxiliary Converter   | NSAF  | Non-Service Affecting Failures           |
| APTA  | American Public Transit Association                           | O&M   | Operations & Maintenance                 |
| AREMA | American Railway Engineering & Maintenance-of-way Association | OCS   | Overhead Catenary System                 |
| ATO   | Automatic Train Operation                                     | OEM   | Original Equipment Manufacturer          |
| ATPM  | Automatic Train Protection Manual                             | OLE   | Overhead Line Equipment                  |
| ATS   | Automatic Train Supervision                                   | PA    | Project Agreement                        |
| CBTC  | Communications-Based Train Control                            | PAS55 | Publicly Available Standard 55           |
| CCTV  | Closed Circuit Television                                     | RCF   | Rolling Contact Fatigue                  |
| CRT   | Critical Rail Temperature                                     | RFI   | Request for Information                  |
| CSRS  | Central Service Regulatory Subsystem                          | RM    | Restricted Manual                        |
| CWR   | Continuous Welded Rail  | RNT   | Rail Neutral Temperature                 |
| DCU   | Door Control Unit   | RTG   | Rideau Transit Group                     |
| DFF   | Direct Fixation Fastener                                      | RTU   | Remote Terminal Units                    |
| EB    | Emergency Brake   | RVI   | Resident Vehicle Inspector               |
| E/B   | Eastbound   | SAF   | Service Affecting Failures               |
| EDR   | Emergency Door Release  | SAT   | Site Acceptance Test                     |
| FAT   | Factory Acceptance Testing                                    | SCADA | Supervisory Control and Data Acquisition |
| GIDS  | Guideway Intrusion Detection System                           | SI    | Section Insulator                        |
| GUI   | Graphical-User Interfaces                                     | SIW   | Sanding, Inspection and Wash             |
| HMI   | Human Machine Interface                                       | TCMS  | Train Control Management System          |
| HSCB  | High-Speed Circuit Breaker                                    | TCRP  | Transit Cooperative Research Program     |
| HVAC  | Heating, Ventilation and Air Conditioning                     | TPSS  | Traction Power Substation                |
| IO    | Infrastructure Ontario  | TSCC  | Transit System Control Centre            |
| I/O   | Inputs/Outputs  | TTC   | Toronto Transit Commission               |
| IFC   | Issued for Construction                                       | UPS   | Uninterrupted Power Supply               |
| IGBT  | Insulated-Gate Bipolar Transistor                             | UTO   | Unattended Train Operation               |
| IMIRS | Information Management Incident Reporting System              | VDV   | Verband Deutscher Verkehrsunternehmen    |
| LMB   | Light Maintenance Bay   | VLD   | Voltage Limiting Device                  |
| LRV   | Light Rail Vehicle  | VOBC  | Vehicle On-Board Controllers             |
| LV    | Low Voltage   | W/B   | Westbound                                |
| MA    | Movement Authority  | WEL   | White-etching Layer                      |
| MMS   | Maintenance Management System                                 | WO    | Work Order                               |
| MPU   | Main Processing Unit  | WRI   | Wheel Rail Interface                     |
| MSF   | Maintenance Storage Facility                                  | ZC    | Zone Controller                          |

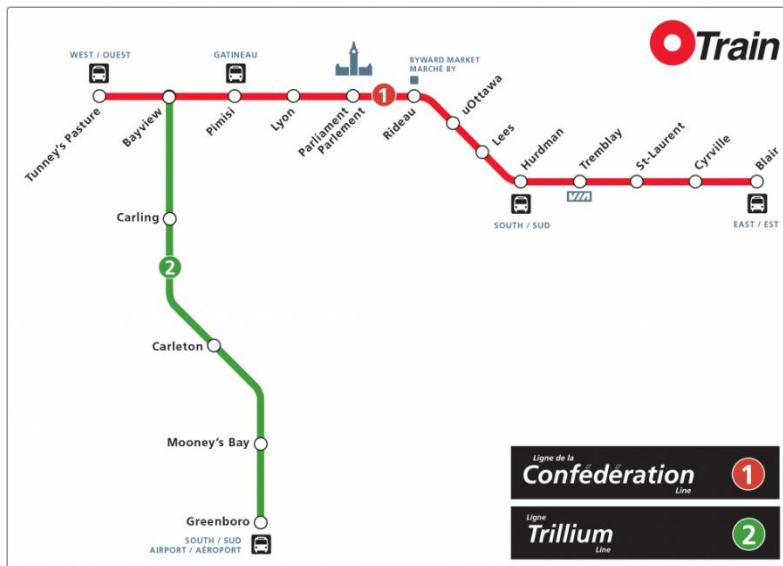
# 1 Introduction

Mott MacDonald has been engaged by the City of Ottawa (“City”) to provide Independent Review (“Independent Review”) services regarding the Confederation Line LRT Stage 1 Light Rail Transit project (the “Project”), designed, built, and maintained by the Rideau Transit Group “Project Co.”

The purpose of this report is to summarize Mott MacDonald’s findings regarding the review of the trackwork, OCS, vehicles, rail systems, as well as provide a summary of recommended changes or repairs or upgrades that are required to improve the performance of the Project systems, and Project Operations and Maintenance. The review included evaluation of the Belfast Road Maintenance Service Facility (“MSF”) and the ability of the MSFs to operate successfully as the LRV fleet number is increased during Stage 2 of the project, as well as documenting the conditions and potential issues seen in relation to the derailments within the MSF facility and elsewhere.

## 1.1 Background

The Confederation Line is part of the City’s O-Train light rail system, and is the second O-Train line opened, operating on an east to west route to complement the north-to-south Trillium Line. The System uses light rail rolling stock and technology (e.g., pantograph current collection from overhead catenary rather than a third rail) and is completely grade separated.



**Figure 1.1: O-Train System Map**

The Project is being delivered under a Design-Build-Finance-Maintain PA, which is based on Alternative Finance and Procurement, which is a procurement method that has been used on other similar projects in Ontario.

The Project began operations in September 2019; however, since that time passengers have experienced a number of service issues. Given the performance issues, the City issued a Notice of Default under the PA on March 10, 2020, followed by a Rectification Notice, which required Project Co to provide a rectification/remediation plan (the “Rectification Plan”). Project Co

This report has been developed under a privileged and confidential assignment on behalf of the City of Ottawa. While the report has been prepared for release to City Council as requested by the City and counsel to the City, neither the City nor its’ counsel waive privilege for the overall assignment.

delivered two versions of its Rectification Plan, one on March 31, 2020, and one on April 24, 2020, but the City rejected both versions for lack of detail and gave Project Co a deadline of August 4, 2020, subsequently extended to September 8, 2020, and again in March 2021, to restore service quality to a level that is below the Warning Notice and Default Failure Point thresholds as set out in the PA.

## 1.2 Independent Review

The City engaged Mott MacDonald through counsel to conduct the Independent Review. This includes the analysis and collection of evidence to document the conditions and potential issues with the infrastructure, vehicles, systems, and maintenance practices designed, built and/or implemented by Project Co, as well as an analysis of the performance of the System. It also includes a summary of recommended changes, repairs, or upgrades that are required to assure the performance of the System.

The work was conducted with initial focus on known issues stemming from the design and construction of the track, OCS, and the vehicles, followed by review of Project systems, and Project Operations and Maintenance, as well as review of any other elements that our initial assessment of known issues with the track, OCS and vehicles identified for further investigation.

As part of this ongoing review, Mott MacDonald also conducted a review of the Belfast Road Maintenance Service Facility and assessed the physical infrastructure as well as the process for planning, preparing and executing the servicing, maintenance and operation of the vehicles as required for safe operation of the Project. In addition, the MSF review also included physical site inspections to inspect, measure and record track gauge dimensions within the yard and the tunnel outlet where the MSF lead tracks connect with the mainline, as some of these locations have had more than one derailment occurring since the facility has operated trains.

To complete the assignment, Mott MacDonald has engaged a team of subject matter experts from around the globe to review and comment on the issues found. The range of specialists has covered all engineering disciplines required to provide required to fully address the issues

Mott MacDonald conducted a review of available background material, and assessed failures/issues against defined City requirements as well as Project Co derived requirements, investigated the design, and validated remedial activities implemented. The approach also included meetings with City and Project Co staff, where needed. Early-stage investigations were then used to guide later stages of the study when more in depth data collection, and site reviews and assessments, were carried out.

Mott MacDonald's review of the performance of the System is described further in the following Volumes of this Report and includes a summary of recommended changes or repairs or upgrades to improve the performance of the System. This includes Mott MacDonald's determination of required interventions, to identify actions against sources of unreliability, and deliver maximum benefit to System performance in the least amount of time.

Throughout our review, Mott MacDonald has endeavoured to be clear upon what basis we are providing any opinion. In doing so we have sought to distinguish between:

- PA/Output Specification requirements; or
- Project Co commitment(s) or requirement(s) from one of their published plans or procedures (if not explicit in the PA); or
- Project Co activity that we do not believe meets "Good Industry Practice" (as it related to design and construction, and/or operations and maintenance) as required by PA, item 9.2(a)(ii)(D), and defined in PA Schedule 1 "Definitions" item 1.238.

Please note that any capitalized terms that are not defined in this report are used in the same sense as defined by the Project Agreement.

Please also note that this report has been developed under a privileged and confidential assignment on behalf of the City of Ottawa. While the report has been prepared for release to City Council as requested by the City and City Counsel, neither the City nor City Counsel have agreed to waive privilege over the overall assignment.

### 1.3 Document Review

The document review included:

- Project Agreement and project specification requirements for each area
- Project Co's monthly Performance Monitoring Reports
- List of Project Co's Contract Deliverables to identify what was required and what has been delivered
- Project Co's Integration Matrix and any supporting documentation
- Project Co's Issues list and Risk Register
- Project Co's Traceability Matrix potentially any lower-level derived specifications (if possible) and select verification/validation (analysis, testing, etc.) documents
- Project Co's Interface Control Document (or similar)
- Design and construction information: Issued for Construction ("IFC") Drawings, Specification, Field Changes, Quality Records, and record drawings
- Project Co's maintenance plans
- Documentation relevant to known failures/issues and Project Co's Rectification Plans

Thirty (30) document requests were tracked via a Mott MacDonald RFI log, which is included as Appendix A. At this time, responses to RFIs submitted to Project Co on these issues remain outstanding. These include the following RFIs:

- Track RFI 016
- Rail Systems RFI 010, 012, 019, 022, 024
- Communications Based Train Control RFI 020
- Rolling Stock RFI 09, 010, 011, 012, 025, 026, 28, 30

As part of the Independent Review, Mott MacDonald requested background information from Project Co. Document requests were tracked via a Request for Information ("RFI") log, which is included as in Volume 7. In many cases, the requests were to provide documentary evidence or proof that a proposed rectification, as proposed by Project Co, has, in fact, been undertaken. At this time, responses to RFIs submitted to Project Co on many of these RFIs remain outstanding, so that Mott MacDonald could not make a conclusive assessment as to the efficacy of the measures implemented, with respect to those issues. In the absence of the documentary evidence, Mott MacDonald has worked to provide our assessment of whether any proposed rectification was likely to mitigate the given issue, though our opinion is subject to change should requested details be provided later

This report has been prepared for release as requested by the City, as the City desired to inform City Council as to our efforts, and findings, to date, in spite of the fact that Mott MacDonald cannot definitely confirm our findings related to all issues noted, due to the time it has been taking for Mott MacDonald to receive answers to our various RFIs.

## 1.4 The Structure of this Report

Given the varying nature of the work elements, this report has been divided into seven “Volumes,” as follows:

- Volume 1: Executive Summary and Introduction
- Volume 2: Project Co Failure Points
- Volume 3: Track and Rail Systems
- Volume 4: MSF
- Volume 5: Revenue Vehicles
- Volume 6: Compiled Recommendations
- Volume 7: Compiled Appendices

Each Volume contains a brief summary, technical observations and findings, and detailed recommendations, as appropriate, all related to the specific work element that is the topic of the Volume. Volume 7 contains the compiled Appendices for all of the other volumes in this report.

# **Volume 2: Project Co Failure Points**

April 2022  
Confidential

# Contents

|   |           |
|---|-----------|
| Volume 2 Summary                        | i         |
| Introduction to Volume 2                | ii        |
| 1.1 Background                          | ii        |
| 1.2 Project Co Document Review          | ii        |
| <b>2 Failure Points</b>                 | <b>5</b>  |
| 2.1 Analysis of Failure Points          | 5         |
| 2.1.1 Review of Failure Points Incurred | 5         |
| 2.1.2 Failure Point Thresholds          | 7         |
| 2.2 Mott MacDonald Opinion              | 9         |
| <b>3 Summary – Failure Points</b>       | <b>11</b> |

## Tables

|   |   |
|---|---|
| Table 2.1: Project Co's performance against thresholds for Warning Notice, Monitoring Notice, Remedial Rights, Project Co Event of Default and Replacement of Non-Performing Maintenance Contractor for Vehicle and System Availability Failures only (*) | 8 |
| Table 2.2: Anticipated compliance with 12-month Project Co Event of Default threshold (subject to assumptions below)  | 8 |

## Figures

|  |   |
|--|---|
| Figure 2.1: Aggregate Vehicle Kms Availability Ratios since September 2019 | 6 |
| Figure 2.2: Vehicle Kms Availability Failure Points since September 2019   | 6 |
| Figure 2.3: System Events Availability Failure Points since September 201  | 7 |

## Volume 2 Summary

Volume 2 of this Report contains Mott MacDonald's observations and findings related to the Failure Point regime as detailed in Schedule 20 of the PA, and the City's issuance of the March 2020, and September 2021 Notices of Default.

### Project Co Failure Points

Based on the Failure Points incurred prior to the March 10, 2020 Notice of Default for Aggregate Vehicles Kms Availability and System Events, the issuance of the Notice of Default was consistent with Mott MacDonald's calculations, as illustrated in **Table 2.1**.

Subsequently, there were two derailment incidents in August and September 2021, causing the Failure Points to increase again and breach the threshold for Project Co Event of Default. These incidents prompted the City to issue a second Notice of Default on September 24, 2021. The issuance of the second Notice of Default was also consistent with Mott MacDonald's calculations.

Although Volume 2 is focused on the level of Failure Points incurred, it is worth noting that Failure Points do not give the full picture of operational and maintenance issues. Volumes 3 and 5 provide a more in-depth review of technical and operational issues, some of which may not have impacted the level of Failure Points incurred to date. For example, Mott MacDonald has been informed by the City that several vehicles appeared to be unavailable due to a combination of missing/defective equipment and by having exceeded their maintenance periodicity limits

In response to the March 2020 Notice of Default Project Co developed the Rectification Plan. The implementation of the Rectification Plan, and the overall monitoring of operational performance, appear to be lacking in the following areas:

- Monitoring and recording process to assemble relevant data and provide traceability and continuity on how often assets have been adjusted, replaced, how long they have run, and the magnitude of any adjustments or replacements that have been made. Without such data, it is difficult to identify quantifiable trends for any changes made to the infrastructure
- Root-cause analysis of several recurring issues to resolve the source of the issues rather than their operational impacts

Accordingly, known technical issues for the Project, including those that have a potential impact on Vehicles Kms Availability and could subsequently translate into Failure Points/Project Co Events of Default, are summarized in **Table 2.2**, and should be monitored closely.

As shown in **Figure 2.1** the Aggregate Vehicle Kms Availability Ratio remained below the 98.0% threshold (hence incurring Failure Points) during 15 of the 31 months (September 2019 to March 2020, July and September 2020, August to November 2021, and January and February 2022) reviewed as part of this analysis.



# Introduction to Volume 2

Mott MacDonald has reviewed the Failure Points accrued by Project Co that resulted in the City issuing Notices of Default in March 2020 and September 2021. Following the reconciliation of Failure Points with the technical issues identified by our subject matter experts in other Volumes of the report, Mott MacDonald has formed its independent opinion on the Notices of Default, Project Co's ability to cure Project Co's Event of Default, and its ability to remain below the associated Failure Point threshold.

## 1.1 Background

In its Notice of Default issued on March 10, 2020, the City refers to several clauses of the Project Agreement in relation to Project Co's Events of Default. As a technical Independent Reviewer, Mott MacDonald has investigated the circumstances of Project Co Events of Default that relate to the Failure Points for Aggregate Vehicle Kms Availability and System Events (together referred to as Vehicles Availability Ratios for the purpose of this analysis). Service and Quality Failures have been excluded from the analysis, as these have been excluded from the Notices of Default.

Mott MacDonald has reviewed the Failure Points and associated work orders reported in Project Co's Information Management Incident Reporting System tracker and Project Co's monthly Performance Monitoring Reports to report, categorize, and analyze the events that led to the accumulation of Failure Points between September 2019 and March 2022, as it relates to Aggregate Vehicle Kms Availability and System Events. Although we understand that Project Co has adjusted a number of Failure Points recorded by the IMIRS, this report focuses solely on the Failure Points recorded by the IMIRS (unless otherwise specified).

## 1.2 Project Co Document Review

As it applies to our review of the application of Failure Points and issuance by the City of the Notices of Default, the document review included:

- Project Agreement and project specification requirements
- Project Co's Performance Monitoring Reports from September 2019 to March 2022
- Documentation relevant to known failures/issues and Project Co's Rectification Plans

## 2 Failure Points

### 2.1 Analysis of Failure Points

#### 2.1.1 Review of Failure Points Incurred

Based on the Vehicles Availability Ratios (Aggregate Vehicle Kms Availability and System Events) self-reported by Project Co, Mott MacDonald considers that Project Co was in an Event of Default per the terms of the Project Agreement as early as September 2019, as illustrated in **Table 2.1**.

With the exception of July 2020 (when cracks in the wheels of the vehicles were discovered, which resulted in the need to stop vehicles to carry out specific inspections), Failure Points for Vehicles Availability Ratios generally decreased from March 2020 to July 2021. However, this observation must be considered in conjunction with the following wider context:

- Data collected in the spring and summer 2020 in Alstom's monthly reliability reports showed a high volume of vehicle failures (service affecting and non-service affecting), which did not translate into Failure Points for Vehicles Availability Ratios; and
- Reduced ridership and fewer trains required to meet the service level requirements during the COVID-19 pandemic (for example, only eight trains were required in the spring 2020, and 11 trains were running in March 2022). A Temporary Service Level Decrease was agreed in a Term Sheet to address the service level changes.

The July 2020 performance was primarily affected by poor Vehicles Kms Availability Ratios (i.e., Aggregate Vehicle Kms Availability and System Events), which was related to the discovery of cracks in the wheels of the vehicles and subsequent investigations. Project Co was able to ramp up its Vehicles Kms in the following months and performance for Vehicles Kms Availability remained strong until August 2021, as demonstrated in **Figure 2.1**. Note the stronger performance in mid-2020 is despite the high volume of service affecting and non-service affecting vehicle failures reported in the Alstom monthly reports that Mott MacDonald was able to review, from May to September 2020. Failure Points for Vehicles Availability Ratios significantly increased from August to November 2021 as a result of service interruptions associated with the August 8, 2021 and September 19, 2021 derailments.

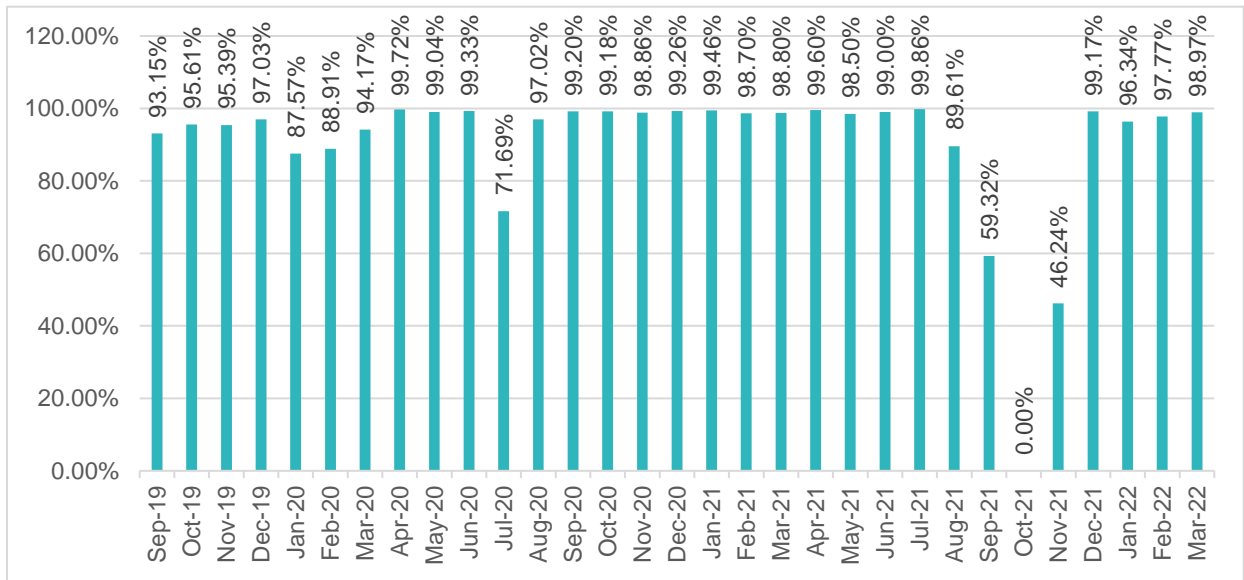
Further details on the Failure Points incurred for Aggregate Vehicle Kms Availability and System Events is provided below.

#### Aggregate Vehicle Kilometres Availability

Pursuant to Appendix C [Failure Points] of Schedule 20 [Payment Mechanism] to the Project Agreement, Failure Points shall be awarded in each Contract Month based on the Aggregate Vehicle Kms Availability Ratio calculated for that Contract Month. Failure Points are incurred for Aggregate Vehicle Kms Availability Ratios of below 98.0%.

As captured in **Figure 2.1** below, the Aggregate Vehicle Kms Availability Ratios remained below the 98.0% ratio threshold (hence incurring Failure Points) during 15 of the 31 months between September 2019 and March 2022. More specifically, the 98.0% target was not achieved in September 2019 to March 2020, July and September 2020, August to November 2021, or January 2022 and February 2022.

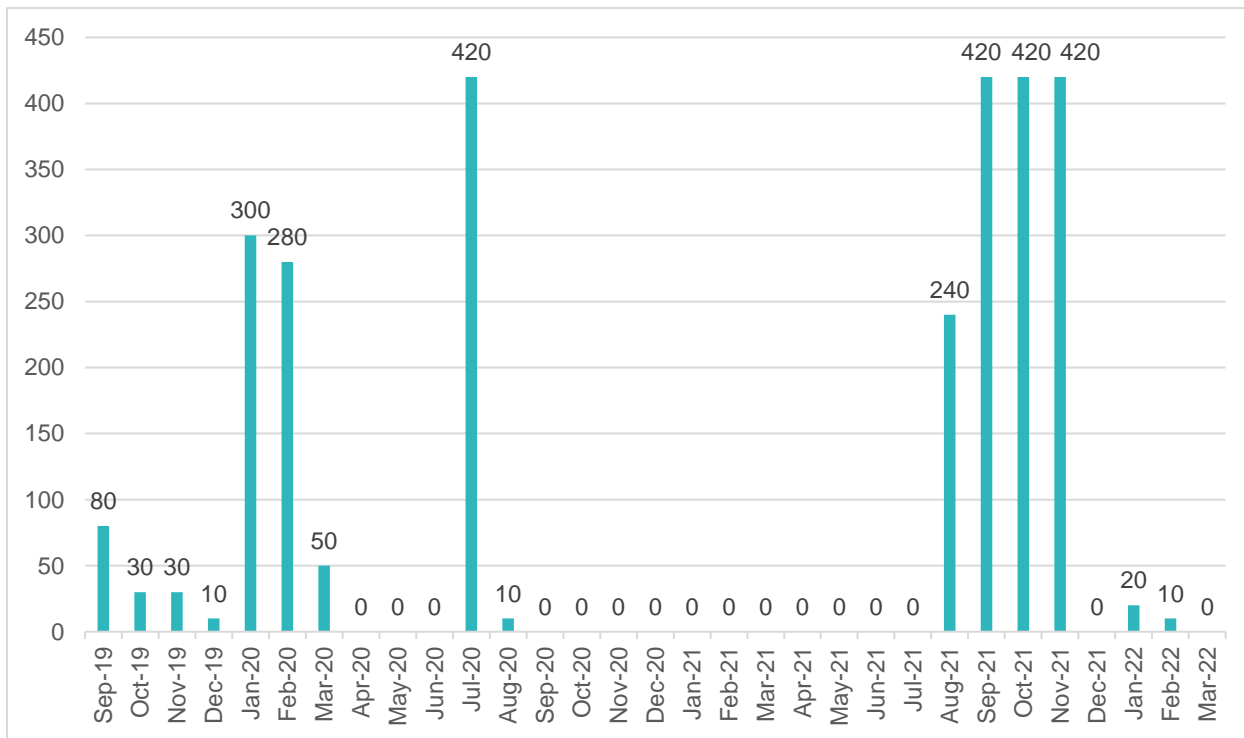
**Figure 2.1: Aggregate Vehicle Kms Availability Ratios since September 2019**



Source: Project Co's Performance Monitoring Reports (September 2019 to March 2022)

The performance of Vehicle Kms Availability was notably poor in January 2020, February 2020, July 2020, and August to November 2021, when services were offline because of investigations related to malfunctions (including cracks in the wheels of the vehicles and derailments).

**Figure 2.2: Vehicle Kms Availability Failure Points since September 2019**

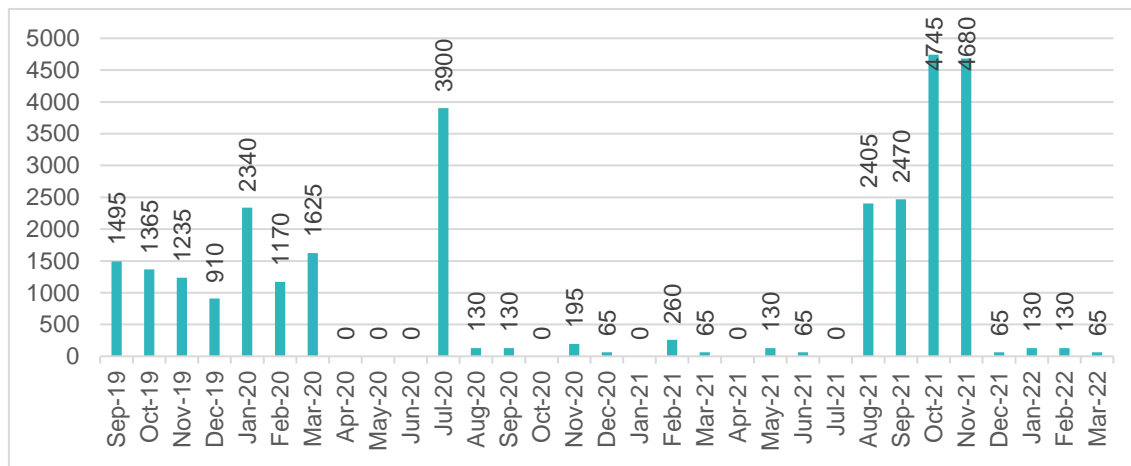


Source: RTG's Performance Monitoring Reports (September 2019 to March 2022)

### System Events

Unlike the Vehicle Kms Availability Ratio that measures performance monthly, the System Events assess Vehicles Kms Availability Ratios during peak periods (morning and afternoon) and over single days. In general, System Events tend to be recorded when the Vehicle Kms Availability Ratio is performing poorly. Failure Points for System Events were notably high prior to April 2020, in July 2020, and from August to November 2021, which is a similar trend to that of the Vehicles Kms Availability and is driven by services being offline because of investigations related to malfunctions (including cracks in the wheels of the vehicles and derailments). Failure Points for System Events are captured in **Figure 2.3**.

**Figure 2.3: System Events Availability Failure Points since September 2019**



Source: RTG’s Performance Monitoring Reports (September 2019 to March 2022)

#### 2.1.2 Failure Point Thresholds

The Project Agreement includes a series of Failure Point thresholds that enable the City to initiate notices to Project Co, including a Warning Notice, a Monitoring Notice, a Notice of the City’s exercising its Remedial Rights, a Notice of Replacement of Non-Performing Maintenance Contractor, and a Notice of Project Co Event of Default.

In **Table 2.1** below, Project Co’s self-reported Failure Points are assessed against the Project Agreement Failure Point thresholds.

**Table 2.2: Project Co’s performance against thresholds for Warning Notice, Monitoring Notice, Notice of Exercising of Remedial Rights, Notice of Project Co Event of Default and Notice of Replacement of Non-Performing Maintenance Contractor for Vehicle and System Availability Failures only (\*)**

|                    | Warning Notice                               |  |                                       | Monitoring Notice                                       |  |                                       | Remedial Rights                              |  |                                       | Project Co Event of Default                               |   |  | Replacement of Non-Performing Maintenance Contractor               |  |                                       |
|--------------------|--|--|---------------------------------------|---|--|---------------------------------------|--|--|---------------------------------------|---|---|--|--|--|---------------------------------------|
| Thresholds         | 120 Failure Points in any one Contract Month |  |                                       | 240 Failure Points in any rolling three Contract Months |  |                                       | 300 Failure Points in any one Contract Month |  |                                       | 1,300 Failure Points In any rolling three Contract Months | 1,600 Failure Points In any rolling six Contract Months | 2,000 Failure Points In any rolling twelve Contract Months | Threshold: 1,000 Failure Points in any rolling six Contract Months |  |                                       |
| Failure Categories | Vehicle & System Availability Failures       | Of which Vehicle Kms Availability Failures | Of which System Availability Failures | Vehicle & System Availability Failures                  | Of which Vehicle Kms Availability Failures | Of which System Availability Failures | Vehicle & System Availability Failures       | Of which Vehicle Kms Availability Failures | Of which System Availability Failures |   |   |  | Vehicle & System Availability Failures                             | Of which Vehicle Kms Availability Failures | Of which System Availability Failures |
| Sept-19            | 1,575  | 80   | 1,495                                 | 1,575   | 80   | 1,495                                 | 1,575  | 80   | 1,495                                 | 1,575   | 1,575   | 1,575  | 1,575  | 80   | 1,495                                 |
| Oct-19             | 1,395  | 30   | 1,365                                 | 2,970   | 110  | 2,860                                 | 1,395  | 30   | 1,365                                 | 2,970   | 2,970   | 2,970  | 2,970  | 110  | 2,860                                 |
| Nov-19             | 1,265  | 30   | 1,235                                 | 4,235   | 140  | 4,095                                 | 1,265  | 30   | 1,235                                 | 4,235   | 4,235   | 4,235  | 4,235  | 140  | 4,095                                 |
| Dec-19             | 920  | 10   | 910                                   | 3,580   | 70   | 3,510                                 | 920  | 10   | 910                                   | 3,580   | 5,155   | 5,155  | 5,155  | 150  | 5,005                                 |
| Jan-20             | 2,640  | 300  | 2,340                                 | 4,825   | 340  | 4,485                                 | 2,640  | 300  | 2,340                                 | 4,825   | 7,795   | 7,795  | 7,795  | 450  | 7,345                                 |
| Feb-20             | 1,450  | 280  | 1,170                                 | 5,010   | 590  | 4,420                                 | 1,450  | 280  | 1,170                                 | 5,010   | 9,245   | 9,245  | 9,245  | 730  | 8,515                                 |
| Mar-20             | 1,675  | 50   | 1,625                                 | 5,765   | 630  | 5,135                                 | 1,675  | 50   | 1,625                                 | 5,765   | 9,345   | 10,920   | 9,345  | 700  | 8,645                                 |
| Apr-20             | 0  | 0  | 0                                     | 3,125   | 330  | 2,795                                 | 0  | 0  | 0                                     | 3,125   | 7,950   | 10,920   | 7,950  | 670  | 7,280                                 |
| May-20             | 0  | 0  | 0                                     | 1,675   | 50   | 1,625                                 | 0  | 0  | 0                                     | 1,675   | 6,685   | 10,920   | 6,685  | 640  | 6,045                                 |
| Jun-20             | 0  | 0  | 0                                     | 0   | 0  | 0                                     | 0  | 0  | 0                                     | 0   | 5,765   | 10,920   | 5,765  | 630  | 5,135                                 |
| Jul-20             | 4,320  | 420  | 3,900                                 | 4,320   | 420  | 3,900                                 | 4,320  | 420  | 3,900                                 | 4,320   | 7,445   | 15,240   | 7,445  | 750  | 6,695                                 |
| Aug-20             | 140  | 10   | 130                                   | 4,460   | 430  | 4,030                                 | 140  | 10   | 130                                   | 4,460   | 6,135   | 15,380   | 6,135  | 480  | 5,655                                 |
| Sept-20            | 130  | 0  | 130                                   | 4,590   | 430  | 4,160                                 | 130  | 0  | 130                                   | 4,590   | 4,590   | 15,510   | 4,590  | 430  | 4,160                                 |
| Oct-20             | 0  | 0  | 0                                     | 270   | 10   | 260                                   | 0  | 0  | 0                                     | 270   | 4,590   | 12,540   | 4,590  | 430  | 4,160                                 |
| Nov-20             | 195  | 0  | 195                                   | 325   | 0  | 325                                   | 195  | 0  | 195                                   | 325   | 4,785   | 11,470   | 4,785  | 430  | 4,355                                 |
| Dec-20             | 65   | 0  | 65                                    | 260   | 0  | 260                                   | 65   | 0  | 65                                    | 260   | 4,850   | 10,615   | 4,850  | 430  | 4,420                                 |
| Jan-21             | 0  | 0  | 0                                     | 260   | 0  | 260                                   | 0  | 0  | 0                                     | 260   | 530   | 7,975  | 530  | 10   | 520                                   |
| Feb-21             | 260  | 0  | 260                                   | 325   | 0  | 325                                   | 260  | 0  | 260                                   | 325   | 650   | 6,785  | 650  | 0  | 650                                   |
| Mar-21             | 65   | 0  | 65                                    | 325   | 0  | 325                                   | 65   | 0  | 65                                    | 325   | 585   | 5,175  | 585  | 0  | 585                                   |
| Apr-21             | 0  | 0  | 0                                     | 325   | 0  | 325                                   | 0  | 0  | 0                                     | 325   | 585   | 5,175  | 585  | 0  | 585                                   |
| May-21             | 130  | 0  | 130                                   | 195   | 0  | 195                                   | 130  | 0  | 130                                   | 195   | 520   | 5,305  | 520  | 0  | 520                                   |
| Jun-21             | 65   | 0  | 65                                    | 195   | 0  | 195                                   | 65   | 0  | 65                                    | 195   | 520   | 5,370  | 520  | 0  | 520                                   |
| Jul-21             | 0  | 0  | 0                                     | 195   | 0  | 195                                   | 0  | 0  | 0                                     | 195   | 520   | 1,050  | 520  | 0  | 520                                   |
| Aug-21             | 2,645  | 240  | 2,405                                 | 2,710   | 240  | 2,470                                 | 2,645  | 240  | 2,405                                 | 2,710   | 2,905   | 3,555  | 2,905  | 240  | 2,665                                 |
| Sept-21            | 2,890  | 420  | 2,470                                 | 5,535   | 660  | 4,875                                 | 2,890  | 420  | 2,470                                 | 5,535   | 5,730   | 6,315  | 5,730  | 660  | 5,070                                 |
| Oct-21             | 5,165  | 420  | 4,745                                 | 10,700  | 1,080                                      | 9,620                                 | 5,165  | 420  | 4,745                                 | 10,700  | 10,895  | 11,480   | 10,895   | 1,080                                      | 9,815                                 |
| Nov-21             | 5,100  | 420  | 4,680                                 | 13,155  | 1,260                                      | 11,895                                | 5,100  | 420  | 4,680                                 | 13,155  | 15,865  | 16,385   | 15,865   | 1,500                                      | 14,365                                |
| Dec-21             | 65   | 0  | 65                                    | 10,330  | 840  | 9,490                                 | 65   | 0  | 65                                    | 10,330  | 15,865  | 16,385   | 15,865   | 1,500                                      | 14,365                                |
| Jan-22             | 150  | 20   | 130                                   | 5,315   | 440  | 4,875                                 | 150  | 20   | 130                                   | 5,315   | 16,015  | 16,535   | 16,015   | 1,520                                      | 14,495                                |
| Feb-22             | 140  | 10   | 130                                   | 355   | 30   | 325                                   | 140  | 10   | 130                                   | 355   | 13,510  | 16,415   | 13,510   | 1,290                                      | 12,220                                |
| Mar-22             | 65   | 0  | 65                                    | 355   | 30   | 325                                   | 65   | 0  | 65                                    | 355   | 10,685  | 16,415   | 10,685   | 870  | 9,815                                 |

Source: Project Agreement and RTG’s Performance Monitoring Reports (September 2019 to March 2022)

(\*) All Failure Point thresholds presented in the above table exclude Service, Quality and Station Availability Failures, which have not been factored into the March 10, 2020 Notice of Default

As it relates to the Failure Points captured in the table above (and incurred before and after the issuance of the first Notice of a Project Co Event of Default and the submission of Project Co's first Rectification Plan in March 2020), Mott MacDonald notes the following:

- **September 2019 to March 2020:** Project Co's Vehicles Availability Ratios consistently performed poorly against the Failure Points thresholds: System Event Failure Points were high every month, while the Aggregate Vehicle Kms Availability Ratio were particularly high in January and February 2020. The Failure Points self-reported by Project Co during this period triggered the issuance of the Notice of Project Co Event of Default.
- **April, May, and June 2020:** Project Co performed well against the Failure Points thresholds for Vehicles Availability Ratios in April, May, and June 2020. Contributing factors, such as improved weather conditions and lower ridership (due to the COVID-19 pandemic) likely had a positive impact, in addition to the reduced service levels that were implemented. Performance against the single-month Failure Points thresholds, such as Warning Notice and City's Remedial Rights, which do not take rolling performance into consideration, is compliant with the Project Agreement for the three-month period. Project Co also performed well against the Monitoring Notice threshold for June 2020, which is assessed in a rolling three-month period. Other thresholds measured over six- and 12-month rolling periods remain in breach due to poor historic performance (including pre-April 2020 performance).
- **July 2020:** Vehicle Kms Availability was only 71.69% in aggregate for the month of July 2020, and Project Co consequently accrued a high number of Failure Points associated with Vehicle Kms Availability (including System Events) during this period, resulting in all Failure Points thresholds defined in the Project Agreement being breached in July 2020. Poor performance in July 2020 is due to the discovery of cracks in the wheels of the vehicles and subsequent investigations.
- **August 2020 to July 2021:** Although performance improved from August 2020 to July 2021, Failure Points remained above the threshold for the 12-month rolling period Project Co Event of Default due to poor historic performance (including pre-April 2020 and July 2020) until June 2021. July 2021 is the only month when the Project Co Event of Default threshold was not breached.
- **August 2021 to November 2021:** Project Co incurred a significant amount of Failure Points due to the service shutdowns that followed the August 8, 2021 and September 19, 2021 derailment incidents. During this period, all Failure Point thresholds were breached, including the rolling three-, six-, and 12-month periods for Project Co Event of Default. As a result, the City issued its second Notice of Default on September 24, 2021.
- **December 2021 and January 2022:** Although Project Co incurred fewer Failure Points in December 2021 and January 2022, the three-, six- and 12-month rolling period thresholds continued to be breached due to poor performance related to derailments in August and September 2021, even while Project Co is running at reduced service levels.
- **February and March 2022:** Project Co continued to incur fewer Failure Points for the three to four months since December 2021, hence the three-month rolling period threshold for Project Co Event of Default is no longer in breach, but again while Project Co is running at reduced service levels.

## 2.2 Mott MacDonald Opinion

Based on the Failure Points incurred prior to the March 10, 2020 and the September 24, 2021 Notices of Default for Aggregate Vehicles Kms Availability and System Events, the issuance of the Notices of Default is consistent with Mott MacDonald's calculations, as illustrated in Table 2.2.

Project Co's ability to meet its performance requirements, including Vehicles Availability Ratios, is challenged by the technical and maintenance issues discussed in Volumes 3 and 5 and summarized in **Table 2.2**. Mott MacDonald is concerned by the backlog of deferred maintenance tasks, since deferring maintenance can jeopardize the service if it results in future shutdowns, or needing premature replacement. Mott MacDonald understands that Project Co was previously using new vehicles undergoing manufacture as a source of spare parts for vehicles currently in service that have suffered defects/failures. This allowed for ready repair of the current fleet but ceased being a viable strategy when manufacturing halted in Alstom's Brampton facility. Mott MacDonald has been informed by the City that several vehicles appeared to be unavailable due to a combination of missing/defective equipment and by having exceeded their maintenance periodicity limits (though this has not been confirmed independently). If this unavailability continues, it could impact Project Co's ability to meet the Vehicles Kms Availability ratios requirements, especially when ridership increases post-COVID-19 pandemic.

There is also a lack of accurate data/information gathering that is required to monitor whether changes to infrastructure and on-board equipment including modifications are having the desired effect and will allow Project Co to maintain Vehicle and System Availability Failure Points below the Event of Default threshold on the long term. The implementation of the Project Co Rectification Plan, and the overall monitoring of operational performance, appear to be lacking in the following areas:

- A monitoring and recording process to assemble relevant data and provide traceability (including continuity on how often assets have been adjusted, replaced, how long they have run, and the magnitude of any adjustments or replacements that have been made). Without such data, it is difficult to identify quantifiable trends for any changes made to the infrastructure
- Root-cause analysis of several recurring issues to resolve the source of the issues rather than their operational impacts

Known technical issues for the Project, including those that have a potential impact on Vehicles Kms Availability and could subsequently translate into Failure Points/Project Co Event of Default, are discussed in Volumes 3, 4 and 5.

### 3 Summary – Failure Points

Based on the Aggregate Vehicles Kms Availability and System Events Failure Points self-reported by Project Co prior to the March 10, 2020 and the September 24, 2021 Notices of Default, the issuance of the Notices of Default is consistent with Mott MacDonald's calculations in **Table 2.1**.

Further, it is worth noting that the Failure Points do not give the full picture of operational issues. For example, in the months for which Alstom's Reliability Reports have been provided to Mott MacDonald, the number of both service and non-service affecting reliability events is significant (mostly communications events), including during the period when Vehicles Kms Availability Ratios are below the thresholds established in the Project Agreement. Over the longer term, Mott MacDonald believe that System performance will improve if Project Co complete implementation of their Rectification Plan, and adopt the recommendations made by our technical team in the other Volumes of this report.

Finally, data/information is not obviously gathered and applied by Project Co to support ongoing monitoring of modifications/changes to infrastructure and on-board equipment to indicate success. Project Co's ability to meet its performance requirements (including Vehicles Availability Ratios) is at risk given the expectation that other identified technical issues will be under increased tension when ridership increases after the COVID-19 pandemic.

These items are further discussed in the various Volumes of this report.



# **Volume 3: Track and Rail Systems**

April, 2022  
Confidential

# Contents

|  |           |
|--|-----------|
| Volume 3 Summary   | iv        |
| Introduction to Volume 3   | viii      |
| 2.1 Approach   | viii      |
| 2.2 Document Review  | viii      |
| <b>3 Technical Considerations</b>  | <b>12</b> |
| 3.1 Track  | 12        |
| 3.1.1 Rail Neutral Temperature   | 12        |
| 3.1.2 Switch Heaters   | 25        |
| 3.1.3 Rail Corrugation and Rolling Contact Fatigue   | 26        |
| 3.2 Rail Systems   | 44        |
| 3.2.1 Overhead Catenary System   | 44        |
| 3.2.2 Traction Power   | 61        |
| 3.2.3 GIDS and SCADA   | 71        |
| 3.2.4 CBTC   | 78        |
| <b>4 Recommendations – Track and Rail Systems</b>  | <b>84</b> |
| 4.1 Rail and Track Structure   | 84        |
| 4.1.1 Priority   | 84        |
| 4.1.2 Rail and Track Structure – Other Design and Maintenance  | 85        |
| 4.2 Rail Systems (OCS and Traction Power)  | 85        |
| 4.2.1 Priority   | 85        |
| 4.2.2 Rail Systems – Other Recommendations   | 88        |
| <b>Tables</b>  |           |
| Table 3.1: Locations with Corrugation  | 27        |
| Table 3.2: Maximum Contact Wire Gradients  | 56        |
| <b>Figures</b>   |           |
| Figure 3.1: Diagram showing differential tensile thermal forces (N) forming a stress transition zone     | 15        |
| Figure 3.2: Diagram showing differential compressive thermal forces (N) forming a stress transition zone | 15        |
| Figure 3.3: Highest temperatures recorded at Katoomba between 1991-2020                                  | 19        |
| Figure 3.4: Lowest temperatures recorded at Katoomba between 1991-2020                                   | 20        |
| Figure 3.5: Cab footage showing termination of the restraining rail within a spiral                      | 21        |
| Figure 3.6: Demonstration of the hunting oscillation due to conical wheels                               | 22        |

|   |    |
|---|----|
| Figure 3.7: Expansion joints installed in a “facing” position on the eastbound line                                 | 25 |
| Figure 3.8: Corrugation on Low Rail of Curve 210 at 104+725   | 30 |
| Figure 3.9: Corrugation on Low Rail of Curve 220 at 105+115   | 30 |
| Figure 3.10: Corrugation on High Rail of Curve 220 at 105+115   | 30 |
| Figure 3.11: Corrugation on Low Rail of Curve 230 at 105+655  | 31 |
| Figure 3.12: Corrugation on High Rail of Curve 330 at 108+685   | 31 |
| Figure 3.13: Corrugation on High Rail of Curve 230 at 105+655   | 32 |
| Figure 3.14: Wheel Burns and Periodic Patches on Rail at Blair Terminus   | 32 |
| Figure 3.15: Periodic Patches on Rail at Blair Terminus   | 32 |
| Figure 3.16: Noise Measurement between Hurdman and Leeds for Westbound track  | 34 |
| Figure 3.17: Rolling Contact Fatigue on Low Rail of Curve 210 at 104+725  | 36 |
| Figure 3.18: Rolling Contact Fatigue on Low Rail of Curve 220 at 105+115  | 37 |
| Figure 3.19: Schematic of Rail Wear   | 38 |
| Figure 3.20: RailPod Wear Plot for Westbound Hurdman Curves WB-240 and WB-230                                       | 39 |
| Figure 3.21: RailPod Rail Profiles Curve WB-240 205+928   | 39 |
| Figure 3.22: RailPod Rail Profiles Tangent Track 205+805  | 40 |
| Figure 3.23: RailPod Vertical Wear against Curve Radius   | 40 |
| Figure 3.24: RailPod Side Wear against All Curve Radius   | 41 |
| Figure 3.25: RailPod Side Wear against Curve Radius Less than 500m  | 41 |
| Figure 3.26: Information from 2nd Design Review for Truck Primary Suspension  | 43 |
| Figure 3.27: As-built v Design Contact Wire Height – Eastbound Track  | 48 |
| Figure 3.28: As-built v Design Contact Wire Height - Westbound Track  | 49 |
| Figure 3.29: As-built v Design Contact Wire Gradients – Eastbound   | 50 |
| Figure 3.30: As-built v Design Contact Wire Gradient - Westbound  | 50 |
| Figure 3.31: As-Built v Design Contact Wire Stagger – Eastbound Track   | 51 |
| Figure 3.32: As-built v Design Contact Wire Stagger – Westbound Track   | 52 |
| Figure 3.33: RailPod Data V Design Contact Wire Height for Eastbound Track  | 52 |
| Figure 3.34: RailPod Data V Design Contact Wire Height for Westbound Track  | 53 |
| Figure 3.35: Wear on Pantograph Horn  | 53 |
| Figure 3.36: RailPod Data Analysis of SW313 Crossover Wire Heights  | 54 |
| Figure 3.37: RailPod Data Analysis of SW315 Crossover Wire Heights  | 55 |
| Figure 3.38: Messenger Wire to OCR Jumper Wire  | 55 |
| Figure 3.39: Messenger Wire Cut-in Insulation   | 56 |
| Figure 3.40: OCS to OCS at Crossovers and Turnouts  | 56 |
| Figure 3.41: Underside of Section Insulator   | 57 |
| Figure 3.42: Upper Stop Support Bracket   | 60 |
| Figure 3.43: Lower Stop Bracket   | 60 |
| Figure 3.44: Balance Weight Guide Eyes  | 60 |
| Figure 3.45: Overview of Emergency Brake Events (Overspeed in ATO and Crawlback) Per Month                          | 81 |
| Figure 3.46: Communication Loss Events Per Vehicle. When Operated in Couple, an Event is Allocated to Both Vehicles | 82 |
| Figure 3.47: Redundancy Events (ZC, LSRS, CSRS or ATS Operating on Backup System)                                   | 83 |

# 1 Volume 3 Summary

The purpose of this Volume is to summarize Mott MacDonald's findings regarding the priority review of the trackwork and OCS as well as for the subsequent review of rail systems and other elements of the System, as well as providing a summary of recommended changes, repairs or upgrades that are required to improve the performance of the Project systems, and Project Operations and Maintenance.

## Independent Review – Project Co Rectification Plan

It is Mott MacDonald's assessment of the Rectification Plan dated March 2020, proposed by Project Co ("the Rectification Plan"), that the changes proposed are positive, and, if implemented, are likely to improve the reliability of the system for the future. Despite repeated requests, Mott MacDonald has not received updates regarding the implementation status of the Rectification Plan, or whether the proposed changes made under the Project Co Rectification Plan have solved the issues as intended.

In the absence of complete documentary evidence, Mott MacDonald has worked to provide our assessment of whether each proposed rectification was likely to mitigate the given issue, but our assessment is subject to change should requested documents or other updated information be provided.

## Independent Review – Mainline and Rail Systems

### *Track Design*

Many of the issues associated with the System's trackwork do not typically manifest immediately as issues which incur Failure Points. Instead, the issues seen are causal to downstream problems which will in themselves become factors in the System's overall performance. Examples of track issues that have been experienced, with the potential to lead to downstream problems, include:

- Track buckles associated with the Rail Neutral Temperature potentially resulting in speed restrictions or System stoppages which limit the System's ability to provide the required level of service.
- Track corrugation potentially causing breaches of the System's ride quality and noise and vibration requirements.
- Track corrugation potentially leading to premature deterioration of the condition of the LRVs resulting in increased maintenance or lack of availability for service.

Regarding the issue of RNT, given the limited remedial measures being put in place it is not possible to positively conclude that Project Co's proposal to increase the RNT from 20° C to 25° C will fully correct the issues, predominantly seen at higher temperatures as track buckles. In this Volume we have presented a number of short-term measures that could be implemented to address immediate issues, and a number of strategic and long-term fixes that would result in a more robust track structure, including implementing a proactive maintenance regime, all with the goal to minimize impact on the safe operation of the line.

Corrugation (the periodic wear of the rail surface into peaks and troughs) has been observed to be present by both Mott MacDonald and Project Co, on both rails of the tight radius curves on the Confederation Line. This uneven surface results in high forces between rail and wheel that increases the severity of the corrugation and can result in damage to both track and vehicle. Corrugation is unlikely to limit the availability of the vehicles in the short term but, over extended

durations, the vehicles can experience cyclical loading that can introduce fatigue cracks which can impact safety over time. In addition, corrugation results in high levels of noise that can be a nuisance to neighbours and to those on-board trains who can also experience lower ride quality.

Rail grinding removes the corrugation of the affected sections. It will reduce the high forces and the potential impact on the track and vehicle as well as arrest the development of defects before they become problematic. Project Co has contracted with a grinding contractor who have undertaken grinding of affected sections of the Confederation Line and also with a consultant to provide expert advice in this regard. These grinding programs have taken place; however, grinding the rail to the original profile will not prevent corrugation from forming in future and, given its previous rapid growth, it is likely to require grinding again soon. High growth rates of corrugation and frequent grinding will severely limit the lifespan of the rail.

### *Track Equipment*

Switch Heaters – switches had been observed to freeze during winter, so modifications and upgrades to switch heaters were proposed as part of Project Co's Rectification Plan. At the time of this report, we understand from City representatives that remedial works have been undertaken at the switch heaters, in accordance with the Rectification Plan. These changes to the heaters and the other proposed mitigations should improve the situation, but at this time, it is not possible to validate that all of the concerns regarding switch heaters have been finally addressed.

## **Rail Systems**

### *Overhead Catenary System*

Mott MacDonald carried out an assessment of the proposed modifications of OCS items included within the Rectification Plan proposed by Project Co.

Parafil Rope – a failed Parafil rope, as part of OCS cantilever support, caused a delay in service. A full report of incident/investigation has not been provided by Project Co, but the proposed modifications were included in Project Co's Rectification Plan, indicating a 10-month program to complete work, starting April 2020. With reference to the Project Co Confederation Line Major Issue Plan 20200910, the modifications to the Parafil ropes on the whole System were completed in September 2020. Mott MacDonald have not received any details on any issues found during the work, but with all rectification being completed as proposed, the likelihood of a failure of the Parafil rope should be significantly reduced.

Rigid Rail – the contact wire was pulled out of the rigid rail by maintenance staff removing ground straps and was not due any defect in the rigid rail equipment. A full report of incident/investigation was not provided by Project Co, but the proposed modifications to operations procedures were included in Project Co's Rectification Plan. With reference to the Project Co Confederation Line Major Issue Plan 20200910, the work was complete in April 2020, with earthing stirrups installed on the rigid rail and training of maintenance staff is complete. Mott MacDonald have not received any details of the locations where the stirrups were installed, procedure updates, or evidence of any operator training carried out, but if implemented as proposed, the incident should not reoccur. During our site visit, it was noted that no signs of remedial work were observed at the stirrup locations as mentioned in the Project Co Remedy Rectification Plan Master Schedule 2020-09-10.

OCS Wire Pantograph Interface – it was evident that heavy wear was taking place on the pantograph, reducing the life expectancy of the pantograph carbons and damage to the pantograph horns. Proposed modifications to the overhead contact system were included in Project Co's Rectification Plan including assessment of current OCS configuration compared to

This report has been developed under a privileged and confidential assignment on behalf of the City of Ottawa. While the report has been prepared for release to City Council as requested by the City and counsel to the City, neither the City nor its' counsel waive privilege over the overall assignment.

the detailed design and carrying out modifications accordingly. With reference to the Project Co Confederation Line Major Issue Plan 20200910, the modifications for the mainline and connector were completed in September 2020. There is no mention of any work being required or undertaken in the Yard area. Mott MacDonald has not received any details on work carried out on the main lines and connector, and if/when any work is to be carried out in the Yard area. The pantographs are being monitored to determine if the modifications have reduced the wear on the carbons. To-date, no reports have been received from Project Co on the current status of the pantographs. Based on the results of the review, the changes made will improve the performance of the pantograph-to-OCS interface; however, other issues noted below and not addressed as part of the Project Co Rectification Plan will result in continued excessive wear on the pantograph carbons and OCS, and may lead to additional maintenance and replacement of the pantograph carbons and OCS components on the Revenue Vehicles.

During the assessment and site visit several other items were identified as requiring either a engineering analysis and/or some modifications on site. These included:

- Crossovers and Turnouts – out-of-running contact wires are scraping on pantograph horns due to incorrect profile of contact wire and crossover/turnout cantilever limiting uplift of contact wire.
- Jumper Wires – to provide adequate current carrying capacity of the system, jumper wires are required at the transition from conventional catenary to rigid rail and at crossovers/turnouts.
- Section Insulators – a number of the section insulators are in need of adjustment due to the poor transition of the pantograph. This is causing undue wear on the section insulator and causing chipping on the pantograph carbons.
- Balance Weights – the settings and allowable movement of the weights in balance weight anchor terminations require further assessment as they do not appear to be able accommodate extreme weather conditions, which could result in over- or under-tensioning of the OCS wires and a potential dewirement.

Other issues were identified during the review of the video recordings of the pantograph/OCS interface before and after the mainline modifications as per the Project Co Rectification Plan.

#### *GIDS and SCADA*

Mott MacDonald reviewed the guideway intrusion detection system and supervisory control and data acquisition system by comparing the original project requirements against the Rectification Plan, incident logs, and typical SCADA system logs (with detailed references provided below).

The key operational issues (from the Rectification Plan, SCADA system logs, and discussions with the City of Ottawa, as the Operator) understood by Mott MacDonald included:

- Events generated from the GIDS causing an operational disruption to the light railway, due to interfacing signals between the GIDS and the communications-based train control system.
- Events on the SCADA system causing an operational disruption to the light railway, due to the high volume and categorisation of alarms, e.g., alarm handling and management.

Mott MacDonald has sought documents and information from Project Co that reductions in operational disruption have occurred but has not received any, including the addressing of the above noted points.

It appears that both of the GIDS and SCADA systems are in operation and meet technical aspects of the project requirements, noting that there are still instances of “false positives” in the

GIDS system, and the SCADA system in its current configuration is providing a large volume of alarms that is causing operational disruption which therefore requires further remedy.

### *CBTC*

Mott MacDonald reviewed the performance of the CBTC system based on the Rectification Plan, reliability reports, incident logs and system User Guides provided.

Analysis of the performance of the CBTC system reveals that the system has experienced various initial issue after operation commenced but the frequency of these problems has since reduced, and Project Co has provided software updates on an ongoing basis to further improve the performance of the system, which reflects typical practice. The CBTC system is considered to perform as intended.

### *Traction Power*

Mott MacDonald reviewed the Traction Power systems for the OLRT by comparing the original project requirements against the Rectification Plan, incident logs, SCADA system logs, sub-system design reports and commentary from the City of Ottawa regarding key matters.

The key operational issues (from the Rectification Plan, SCADA system logs, review of design and discussions with the City of Ottawa, as the Operator) understood by Mott MacDonald included:

- Events generated by the SCADA system and recorded in the events log that indicate excessive operation of TPSS Negative Grounding Devices across the network. This is an indicator of equipment fault or setting issues or systemic accessible voltage issues.
- Events generated by the SCADA system and recorded in the events log that indicate high levels of AC and DC tripping of circuit breakers (although event logs provided through 2020 would suggest this has largely diminished over the year).
- Events generated by the SCADA system and recorded in events logs that indicate excess temperature issues in several of the sub-stations. Most notably TPSS08 but also TPSS02, TPSS06 and TPSS07. (Some mitigation has been provided regarding TPSS08 only.)
- Events generated by SCADA and recorded in events logs specifically related to TPSS06 and the frequent recording of high priority DC frame leakage (ground fault) alarms over period Feb-20 to Apr-21.
- Reporting provided by several of the network adjacent utilities, including Enbridge Gas, indicates elevated levels of stray current in the utility infrastructure. There was also evidence of a specific high priority NCR entry regarding missing stray current baselining data when the System was entered into service.

Note: The report acknowledges that the levels of stray current had returned to more normal levels in this part of the network by June 2021. (Further reporting from Enbridge Gas.) This may have coincided with return to normal operation of sealed NGD devices as described in the note below.

- The arcing event on March 3, 2021, at LRV-1117/Parliament Station could be an indicator of issues with high rail potentials, grounding and bonding issues.

Note: The report acknowledges that the response to this event was to run with NGD devices sealed closed across parts of the network for a period of time and as such may have contributed to the elevated levels of stray current as reported by Enbridge Gas on March 3, 2022. (See item above).

Our recommendations are captured later in this Volume, and all recommendations from this report are compiled in Volume 6.



## 2 Introduction to Volume 3

The purpose of this Volume is to summarize Mott MacDonald's findings regarding the priority review of the trackwork and OCS, as well as for the subsequent review of rail systems and those other elements that were identified for review, as well as providing a summary of recommended changes or repairs or upgrades that are required to improve the performance of the Project systems, and Project Operations and Maintenance.

### 2.1 Approach

The Independent Review conducted by Mott MacDonald included analysis and evidence to document the conditions and potential issues with the infrastructure, vehicles, systems, and maintenance practices designed, built and/or implemented by Project Co as well as an analysis of the performance of the system. The Independent Review was intended to provide a summary of recommended changes, repairs, or upgrades required to assure the performance of the system.

The work was conducted with initial focus on known issues stemming from the design and construction of the track, OCS, and the vehicles, followed by review of Project systems, and Project Operations and Maintenance, as well as review of any other elements that our initial assessment of known issues with the track, OCS and rail systems identified for further investigation.

Mott MacDonald conducted a review of available background material, assessed failures/issues against defined City requirements as well as Project Co derived requirements, investigated the design, and validated remedial activities implemented. The approach also included meetings with City and Project Co staff, where needed. Early-stage investigations were then used to guide later stages of the study when more in depth data collection, and site reviews (September 2020) and assessments, were carried out.

The result of the review was analysis of the performance of the System including a summary of recommended changes or repairs or upgrades to improve the performance of the System, as described later in this Volume. This included Mott MacDonald's determination of required interventions, to identify actions against sources of unreliability, and deliver maximum benefit to System performance in the least amount of time.

### 2.2 Document Review

The document review included:

- Project Agreement and project specification requirements for each area
- Project Co's monthly Performance Monitoring Reports
- List of Contract Deliverables to identify what was required and what has been delivered
- Integration Matrix and any supporting documentation
- Issues list and Risk Register
- Traceability Matrix potentially any lower-level derived specifications (if possible) and select verification/validation (analysis, testing, etc.) documents
- Interface Control Document (or similar)
- Design and construction information: Issued for Construction ("IFC") Drawings, Specification, Field Changes, Quality Records, and record drawings



- Maintenance plans
- Documentation relevant to known failures/issues and the Rectification Plans

References used throughout this section of this report are listed in Volume 7.

Thirty (30) document requests were tracked via a Mott MacDonald's RFI log, which is included as Appendix A. At this time, responses to RFIs on these issues remain outstanding, and this remains an area of concern. These include the following RFIs:

- Vehicles / Track RFI 016
- Rail Systems RFI 010, 012, 019, 022, 024
- Communications Based Train Control ("CBTC") RFI 020

In many cases, the requests were to provide documentary evidence or proof that a proposed rectification has, in fact, been undertaken and/or how the works aligns with the rectification plan schedules. In the absence of documentary evidence, Mott MacDonald has worked to provide our assessment of whether the proposed rectification was likely to mitigate the given issue, but our assessment is subject to change should requested documents or other updated information be provided later.

## 3 Technical Considerations

The following sections contain our consolidated findings related to the technical aspects of the Independent Expert Review of the March 2020 Project Co Notice of Default and actions taken under Project Co's Rectification Plan.

### 3.1 Track

Many of the issues associated with the System's trackwork do not typically cause the accumulation of Failure Points immediately, but can be causal to downstream problems which can themselves become factors in the System's overall performance, and thus manifest as issues which incur Failure Points in future.

Based upon a review of the Service Failure Points attributable to track, the primary exception to this was deficiencies with switches and associated switch heaters which are reported through the SCADA system and directly documented. Examples of track issues leading to downstream problems include:

- Track buckles associated with the rail neutral temperature result in speed restrictions or System stoppages which limit the System's ability to provide the required level of service.
- Track corrugation causes breaches of the System's ride quality and noise and vibration requirements.
- Track corrugation leads to premature deterioration of the condition of the LRVs resulting in increased maintenance or lack of availability for service.

#### 3.1.1 Rail Neutral Temperature

There have been number of "sun kinks" or "buckles," on the Ottawa Confederation Line where operation has been compromised (for instance by the imposition of "go slow" orders), to maintain safety, due to misalignments of the track. Sun kinks occur when the thermal expansion of the rail creates lateral forces greater than the inherent resistance in the track formation, causing the track to move in a localized manner. If not addressed, these events represent a derailment risk to trains and impact on the operation of the System. Our Independent Review looked at the way Project Co had specified, designed and implemented the track infrastructure specifically to manage the risks associated with track buckles through thermal expansion, outlining findings and proposing additional mitigations that could be implemented in the short and long term to mitigate the situation.

The following information has been reviewed in this study:

- Project Agreement Schedule 15-2 Part 2 – OTT01: 5456518: v3
- Track Work Design Brief – RES-22-0-0000-DBC-0003 (0)
- Design Criteria Track Alignment and Geometric Design – RES-22-0-0000-DCI-0001 (0)
- Track Alignment As-Built Drawings
- Trackwork As-Built Drawings
- Rectification Plan – RTG-OTT-00-0-LET-0925 b014.ii Track Maintenance – Neutral Temperature
- JBA Confederation Line CWR report version 1.0 – JBACANADA/RTG/024-07-07
- Track Strategy Memo – REJ-06-0-0000-ME-0366
- Trackwork Maintenance Manual – RES-22-0-0000-MAN-0003 (0)

This report has been developed under a privileged and confidential assignment on behalf of the City of Ottawa. While the report has been prepared for release to City Council as requested by the City and counsel to the City, neither the City nor its' counsel waive privilege over the overall assignment.

- Design Brief - Proposed Change to Neutral Temperature – RES-22-0-0000-DBC-0108 A
- Video footage of the route

Project Co's Design Brief, *Proposed Change to Neutral Temperature*, and the Project Co Track Strategy Memo both address one aspect of the reason the track is buckling, which is the change in RNT. However, in addition to the assessment of RNT, there are a number of short-term measures that could be implemented to address immediate risks, and a number of strategic and longer-term fixes that would result in a more robust track structure.

It is worth noting that the JBA Consulting Engineers' Report covers a significant amount of background relating to RNT management proposals, including mitigation measures, and outlines a number of the defects associated with the infrastructure on the Confederation Line, providing accurate commentary on the root causes. However, there are still gaps relating to the infrastructure as designed and built, and limited commentary relating to any proactive maintenance regime to minimize impact on the safe operation of the line. The issues discussed in this Section will overlap some of the items that have been highlighted there but are focused on additional findings not specifically covered thus far.

Given the extreme temperature ranges experienced in Ottawa, defining a neutral temperature is challenging, particularly with the geometric properties associated with a light rail system. The selected range of 10°C – 20°C, as defined in Project Co's Trackwork Design Brief, was identified as low relative to other systems in Ontario and lower than the temperatures calculated using industry guidance from the American Railway Engineering and Maintenance-of-Way Association and the Transit Cooperative Research Program, both of which result in temperatures of approximately 30°C or higher.

JBA's Continuous Welded Rail Management Report (Ref - JBACANADA/RTG/024-07-07) ("the JBA Report"), communicated the real risk of derailments which exists with track buckles and proposed options to reduce their likelihood. Mott MacDonald concurs with JBA's assessment and as discussed in this section has concluded that there is a need to mitigate the issues before temperatures rise again in summer.

Further assessment of the RNT has been carried out and more in-depth conclusions are presented in the following subsections. The Project Agreement did not define the required RNT for the Project nor did it mandate the use of ballast or DF track along the System. Given this, Project Co made a design decision to construct the majority of the surface track with tie and ballast. The PA did mandate a permissible rail break gap for DF track but not for ballasted track and differing RNTs could have been adopted across the System.

At this time, it is not possible to positively conclude that Project Co's proposal, as documented in *Design Brief - Proposed Change to Neutral Temperature* (Document number RES-22-0-0000-DBC-0104 Rev A), will fully correct the issues predominantly seen at higher temperatures as track buckles. The proposed increase in the RNT, from 20°C to 25°C, is considered to be a positive change. However, consideration should be given to other measures, which may include options set out in the JBA's Report, to reduce the likelihood for further occurrences in the future.

Another design decision which is believed to be influencing the occurrence of buckles is the termination of restraining rails and guard rails within the spiral transition curves. The PA required their inclusion based upon specific criteria related to the track's elevation above surrounding infrastructure and the tightness of curve radii. These rails, which are firmly attached to the ties, provide additional stiffness to the structure, restricting track movements and helping prevent buckles from occurring. Our observations indicate that where this stiffness changes while there is still curvature, compounded by the fact that forces exerted by the trains are high as it is steered through the spiral, the forces exceed the ability of the tie and ballast system to

restrain them and the issues occur. Other systems require these additional rails to be extended into the adjacent tangential track. For instance, the Toronto Transit Commission requires these to start on tangent track 3m prior to the beginning of a spiral or circular curve and extend 15m beyond the end of a spiral or circular curve.

Further to the points noted above, the maintenance practices documented are not sufficient to deal with the challenges which have been observed on the System. More robust management of the ballast, to encourage consolidation, providing greater support to the ties, as well as enhanced proactive stress management, during periods of high and low temperature, could act to alleviate problems and prevent safety concerns arising.

### 3.1.1.1 Rail Neutral Temperature Definition

There is extensive calculation and discussion regarding the RNT within both Project Co and JBA documents, with the *Design Brief - Proposed Change to Neutral Temperature* document outlining a proposal to increase the RNT range by 5°C to 15°C-20°C, in order to mitigate buckle risk at higher temperatures while providing limited movement, should rail breaks occur at extreme low temperatures. Unless changes to the trackform are made, any increase in the neutral temperature will result in a change to the projected gap should a rail break occur. However, it is understood that to date, no rail breakages on the Confederation Line have been attributed to stress caused by cold temperatures whereas sun kinks have occurred due to high temperatures.

Based on the data provided in the JBA Report regarding mean temperatures across a period from 1981 to 2019, this average temperature range is between -13°C and 28°C although there will be variations above and below these levels and it is noted temperature variation can occur quickly.

The basis for the definition of the current RNT range between 10°C and 20°C was to manage the potential for extreme events between -38°C and +38°C which is an unusually large temperature range to manage effectively. The RNT range has been defined towards the lower range with focus more towards managing rail breaks given there are no signal track circuits in place to help manage this risk. It is noted that no rail breaks have been recorded on the route that are not attributable to deficient thermite welds although it is inconclusive as to whether this is due to effective lower temperature management through the lower range. Before changes to increase the neutral temperature are made, the consequences should a rail break occur must be assessed and mitigations put in place if deemed necessary following risk assessments.

## Track types

The Trackwork Design Brief Section 6.5 outlines differential performance requirements for rail in different states, which includes differential fixation types identifying:

- Standard Direct Fixation
- Resilient Direct Fixation
- Ballasted Track

As defined in the JBA Report, the network is subject to extremes in weather that result in very high and very low ambient temperatures. These temperature differentials will increase the effect of longitudinal thermal expansion and compression in the rail at these stress transition zones where the track structure changes.

Where temperatures fall to a minimum temperature, including where there is high differential between night and day, the fixed rail will develop a constant tension force although no rail contraction will occur.

This report has been developed under a privileged and confidential assignment on behalf of the City of Ottawa. While the report has been prepared for release to City Council as requested by the City and counsel to the City, neither the City nor its' counsel waive privilege over the overall assignment.

Where there is a differential in longitudinal forces or thermal effect between the differential track sections, this will develop a longitudinal resistance resulting in stress transition zone. Here, the tension force will vary linearly between the tensile forces inherent in the different track sections.

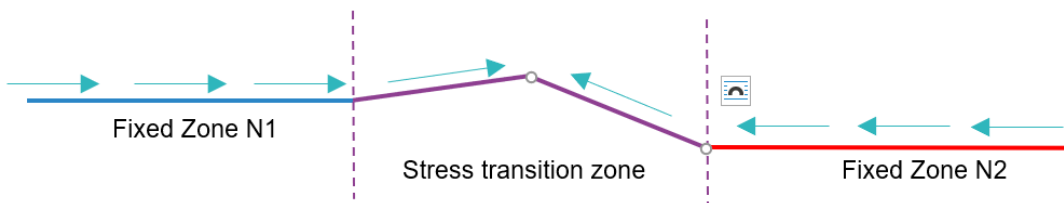
**Figure 3.1: Diagram showing differential tensile thermal forces (N) forming a stress transition zone**



As temperatures rise and fall, the thermal effect on the rail will reverse, either returning to a neutral temperature state (null force) or expanding in higher temperatures, resulting in a compressive force in the rail.

Within the stress transition zone, this will result in a variable compressive force potentially forming a resultant lateral force within the rail.

**Figure 3.2: Diagram showing differential compressive thermal forces (N) forming a stress transition zone**



Over time, this expansion and contraction within the stress transition zone will develop further and the length cannot be accurately evaluated, affecting the RNT within this section. This can result in the forces acting on the transition zone in an irregular way and can retain both compression and tensile forces and contain a higher thermal force than the track either side. At this point, the performance of the track will be unknown and can only be addressed by resetting the neutral temperature.

The tables included in section 6.5 of the Trackwork Design Brief document explore the specific tensile and compressive stresses in the rail but make no reference to the potential interface between the different track forms.

Areas where these behaviours are likely to develop are:

This report has been developed under a privileged and confidential assignment on behalf of the City of Ottawa. While the report has been prepared for release to City Council as requested by the City and counsel to the City, neither the City nor its' counsel waive privilege over the overall assignment.

- At the interface between direct fixation and ballasted track, the section changes in longitudinal resistance inherent in the systems
- Where there is a differential effect in thermal effect from weather extremes, such as between a tunnel (where ambient temperature is relatively stable) and open network
- Where bridge structures have thermal expansion measures independent of the track system

It is therefore important to recognize where these stress transition zones are likely to occur in order to mitigate the risk and meet the requirements. Documents describing or proposing remedial work should be reflective of this, highlighting the potential risks and proposing potential mitigation measures to reduce buckle or rail break risk.

In the documents (noted earlier in this Section) which have been reviewed, the interface areas between the open ballasted track sections and the tunnel sections, do not appear to Mott MacDonald to have been recognized as a potential risk. The track geometry at both the Pimisi and uOttawa tunnel portals is also complex with a compound horizontal curves and vertical curves located coincidentally, increasing dynamic forces in the track (refer to section 6).

Additional mitigation measures (covered in more detail later in this document) should be considered in the short term, such as increased ballast shoulders and localized restraining rails. Consideration should also be given to a regime of routine resetting of the RNT to manage these stress transition zones specifically.

### **Climate Change considerations**

In the JBA Report, the commentary relating to the weather ranges does not make any mention of potential long-term effects or strategies relating to Climate Change. There have been several papers and studies written on the subject given global temperatures and extreme weather events are generally increasing, including *“Impacts of climate change on the operation of the US rail Network”* from the Department of Civil, Environmental and Architectural Engineering, University of Colorado issued in March 2019.

The common theme from these papers is that there is a globally increasing trend in both rising temperatures and extreme weather events, but in almost all cases the recommendation in the papers is not to revise the RNT of the rail but to focus on monitoring and associated technologies in order to proactively manage defects from occurring. The current maintenance regime is discussed in the following section.

#### **3.1.1.2 Maintenance Regime**

The maintenance regime, defined in Chapter 6 of the Maintenance Manual (Ballasted Track Maintenance) listed earlier, is not currently robust enough, as described below, to fully support the requirements of the network in regard to buckle prevention during extreme weather events.

The PA does not definitively require the implementation of RNT management systems and procedures. However, given the known issues relating to RNT, it would be beneficial to the system, and could be considered in line with Good Industry Practice in maintenance, to implement them.

### **Proactive stress management**

There is some mention of possible intervention measures in the JBA Report, although the focus is specifically on mitigations relating to the physical railway. These could provide some level of remedy to the current issues, but there needs to be a process in place to specifically manage extreme events in order to minimize operational risks.

The information provided in the Maintenance Manual does not provide the network with the means to actively manage this critical issue and fails to provide any form of process or define requirements for personnel, beyond undertaking patrols when intervention temperatures are reached.

In many parts of the globe, there is an increasing focus on both hot and cold weather working to mitigate against sunk kinks and rail breaks. In the UK, Network Rail operates over 20,000 miles of track and defines over-arching processes in Network Rail Company Standard NR/L2/TRK/001 Inspection and Maintenance of Permanent Way, Modules 14 (Managing Track in Hot Weather) and 15 (Managing Track in Cold Weather). These processes provide a proven method for actively managing risks in extreme weather conditions.

There appears to be some form of record keeping within the Project as the VIS-04-0-S006-REP-QIF09 form is a stress recording form. It is unclear what the process associated with this Project Co document is, in terms of who is required to complete the form or where the records are kept and managed.

### **Hot weather management**

In the UK, Network Rail's process for managing hot weather risks is underpinned with a national data base of RNT-risk susceptible areas that are identified either by localized, known ongoing issues, or areas where works have been undertaken and ballast is yet to consolidate, as these will affect the track fixity and reduce RNT. The process is referred to as Critical Rail Temperature Management and covers both continuously welded and jointed track configurations.

The process identifies "sites" (in this case the Confederation Line would be considered a site), and assigns responsibility to a CRT co-ordinator to manage. Their role is to input data relevant to the site into the database, including track type, RNT and, where applicable, what works have been undertaken. The criteria defined in Module 14 then provides a method of calculating intervention levels which are also recorded in the database.

These intervention levels determine a targeted range of rail temperatures where additional inspections are required (Watchmen), or if speed reductions are needed to manage dynamic loading from passing trains. The recording of the rail temperatures is done from a remote "stillage" which can be a section of rail, elevated above ground where rail temperatures can be monitored remotely.

Where works have affected the RNT of the track, this is reviewed daily, based on the level of traffic consolidating the ballast, to reflect the improved fixity of the track and would supplement procedures defined in 6.5 of Project Co's Track Maintenance Manual. The consolidation rate would need to be reviewed against the gross tonnage of traffic on the transit system in Ottawa, if this process were adopted.

The CRT database is a very useful tool to the maintenance team in the UK as it allows focus of resource at RNT-risk susceptible areas specifically to mitigate risks, and how to implement a staged management process to keep the railway operating safely. The methodology currently defined in Project Co's Track Maintenance Manual (Ballasted Track Maintenance, Clause 6.5.3) is extremely general, relying on maintenance patrolling with no other defined systems, although does highlight potential RNT-risk susceptible sites.

Monitoring in hot weather could be further supplemented in the longer term by implementing smart infrastructure monitoring, using rail mounted probes that provide real time reporting and automatically register when intervention limits are being reached, triggering messages sent directly to maintenance teams or even drivers to inform them of any speed restrictions.



### **Cold weather management**

The cold weather management procedures defined in 6.5.4 of Project Co's Track Maintenance Manual makes specific reference to extreme temperature interventions and management but is also largely reliant on patrolling of maintenance staff and management, with specific focus on welds.

The previously referenced UK requirements do not need to take into account such extreme weather but do place more emphasis on mitigation measures for seasonal considerations, including prohibiting works below specific temperatures, to ensure rail and alignment integrity and identifying any potential weak points in the railway, such as damaged insulated rail joints.

There is mention of resetting the RNT of rails where the temperature range is higher than the specific range, which having access to a database to identify these sites would facilitate.

### **Differential neutral temperatures**

By developing, maintaining and analysing the information within a stress management register, it would be possible to identify high risk areas for additional mitigations, which include the use of lateral resistance plates, extending restraining rails and increasing ballast shoulders.

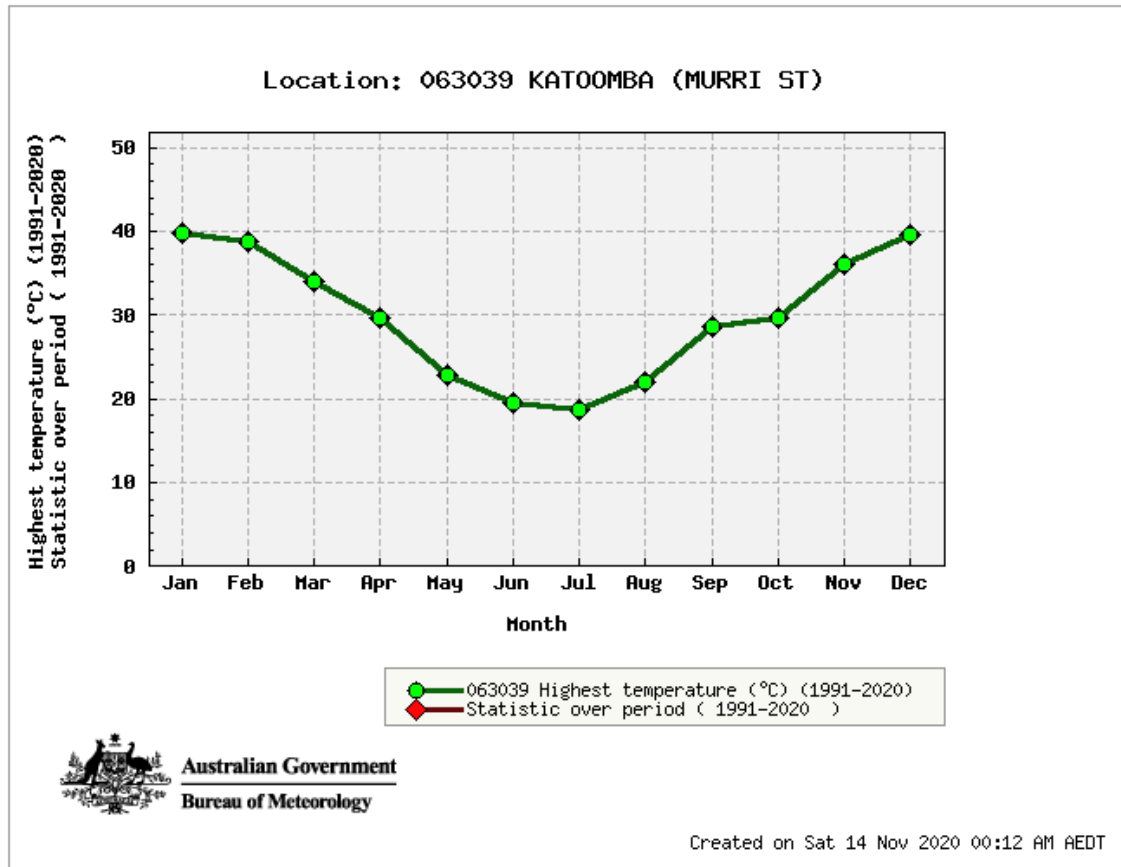
A review of the System would indicate that there are several areas that would be deemed high risk due to the geometry locality of line side structures, although in real terms this will only account for several hundred metres of track. It may therefore be possible to implement a regime of seasonal stressing in these key areas to account for the differential temperature ranges.

Another example of Good Industry Practice for track maintenance in extreme ranges of temperature comes from Sydney Trains in New South Wales, Australia. They currently operate this kind of intervention-based maintenance to manage risk around the town of Katoomba given that this is a section of route that traverses the Blue Mountains. Here, as shown in and there is an extreme temperature range, although not as varying as that found in Ottawa, which Sydney Trains deems to import a level of risk high enough to warrant seasonal stressing to be employed. This regime is reasonably localized, covering around 16km of route, so is viable to undertake.



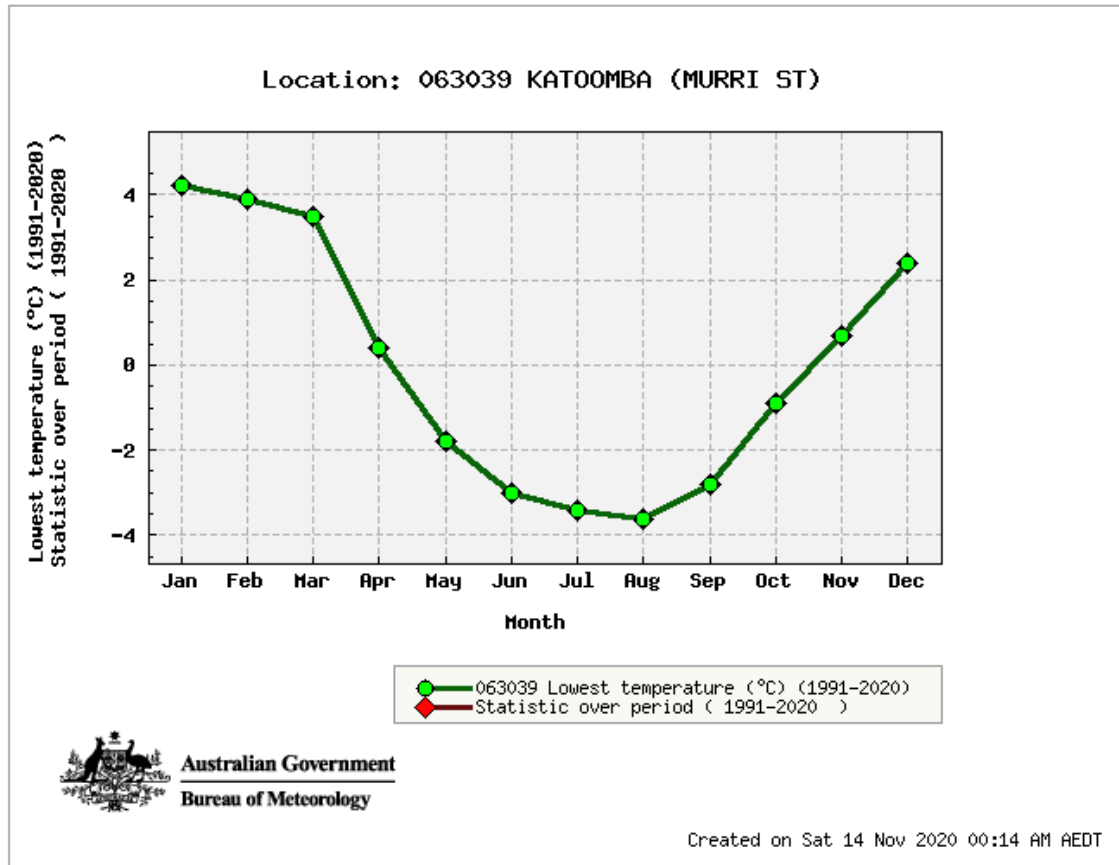
**Figure 3.3: Highest temperatures recorded at Katoomba between 1991-2020**

(Source Australian Bureau of Metrology)



**Figure 3.4: Lowest temperatures recorded at Katoomba between 1991-2020**

(Source Australian Bureau of Metrology)



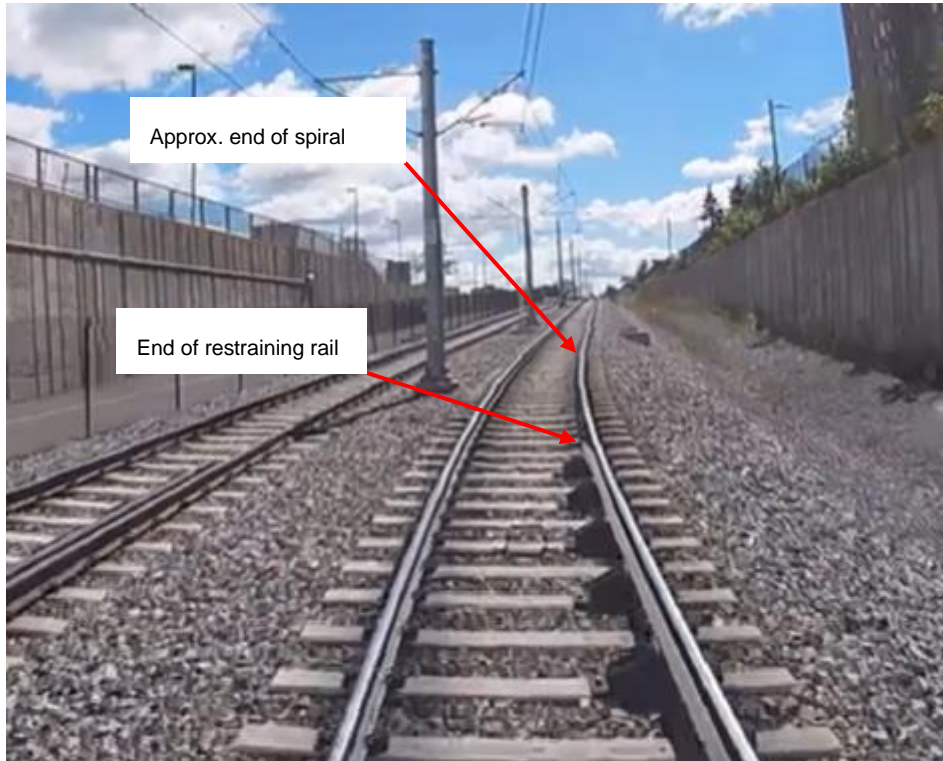
By identifying the RNT-risk susceptible areas and implementing this season-based approach to restressing of the track, this would provide the opportunity to directly address the challenge regarding mitigation of rail breaks against heat expansion and sun kinks/buckles.

### 3.1.1.3 Restraining Rails

The PA mandates the installation of restraining rails to 145m radius curves (Schedule 15-2, Part 2, 3.4.c.i). Restraining rails manage derailment risk by restricting wheel movement on the low rail to prevent wheels on the high rail from climbing over the rail causing a derailment. This requirement has been rigidly adhered to on Confederation Line with indications from both the design drawings and the video footage that restraining rails have been terminated at the point where track radius is 145m. In most instances, this occurs part way through a spiral transition curve.

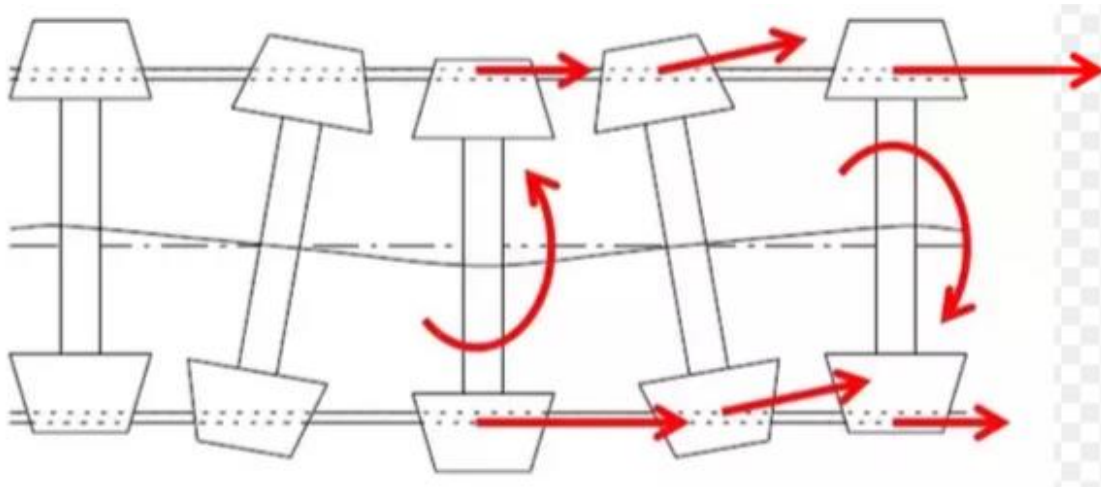
It is important to note that restraining rails have not been used in the yard of the MSF. The Project Co MSF derailment report related to the derailment of LRV 1126 also mentions the lack of restraining rails and includes a recommendation to include them. Since the MSF derailment in Nov 2020 there has been a further, more serious yard derailment in March 2021, at the same tight radius curve location which has resulted in serious damage to the derailed vehicle due to impact damage from coming in to contact with OCS poles and other wayside equipment. Further discussion of the MSF is contained within Volume 4 – MSF.

**Figure 3.5: Cab footage showing termination of the restraining rail within a spiral**



There will be an inherent stiffness differential within track that has three or four rails secured to ties with it being higher than that of a typical two rail arrangement and therefore increased ability to resist against forces as temperatures increase. There will also be additional weight to consider through these sections of track which will make the track more resistant to lateral loading.

The requirements for providing lateral resistance to manage thermal expansion are discussed at length within the JBA Report and there is extensive assessment of the rail stiffness and component parts undertaken and presented within the Technical Specification and the Project Co Trackwork Design Brief documents; however, these do not appear to address system stiffness differential with and without the restraining rails as would be expected in line with Good Industry Practice. As the vehicle traverses the spiral curve, it is constantly changing direction, which adds additional and fluctuating forces into the rail and track structure as the conicity of the wheels act against the rails creating a level of hunting oscillation. By having an instantaneous change in stiffness at the termination of the restraining rail, this introduces an instantaneous reduction in lateral stiffness into the track, increasing the potential for the forces acting on the wheel, to move the track laterally, potentially resulting in a misalignment or buckle.

**Figure 3.6: Demonstration of the hunting oscillation due to conical wheels**

An example of a Good Industry Practice in design and construction is where restraining, or “continuous check rails” are employed is in the UK, where Network Rail Company Standard, NR/L2/TRK/2102 mandates that where these rails are specified, the “*check rail shall be extended to terminate at least 9m into straight track or a curve of constant radius exceeding 200m.*” While this specification is generally associated with jointed track and not CWR, this is intended to provide the opportunity for the wheel or axle to stabilize before removing the additional rail, in part to manage the lateral loading and mitigate against track misalignments.

It is also noted that Project Co’s Track Alignment and Geometric Design document ref: RES-022-0-0000-DCI-0001, defines the desired minimum curve to be 150m radius (CI 5.3.2.1).

As such, further to stopping the restraining rail at the minimum standard of 145m radius curves, is it is recommended that restraining rails are extended into the next constant, geometric element, in accordance with Good Industry Practice, in order to alleviate some of the risk this situation poses.

#### 3.1.1.4 Ballast Management

The JBA Report highlights that ballast shoulder heights have not been defined and ends are generally 25mm lower than top of ties. As observed and documented during the site visits undertaken in September 2020, there is evidence of lateral movement within the track creating voids at the ends of ties which the ballast falls into. This lowers the ballast levels reducing lateral resistance.

The JBA Report makes reference to heaped ballast shoulders which are used across Europe to add mass to the end of ties in order to provided additional resistance, along with other lateral restraining measures, such as lateral end resistance plates and restraining bars, although it does not provide much detail in to how they could be deployed or managed.

A simple recommended mitigation which can be applied quickly would be to identify high risk areas where movements have occurred or may occur and add a ballast shoulder above the tie level. These shoulders would add to resistance, working to limit future movements, and would also refill any voids which form as ties move by allowing ballast to fall back into the pockets as the track realigns when temperatures return to more normal levels. In the UK, 125mm height

would be used as is defined in the Network Rail Track Construction Standard, NR/L2/TRK/2102.

Implementing ballast management measures is one relatively simple and cost-effective process which should help to reduce the risk of future track movements.

### **Track tolerances**

Both the construction tolerances and the maintenance tolerances defined in Project Co's RES-22-0-0000-DBC-0001\_0 and Project Co's Technical Standards and Maintenance Chapter 4 document are defined to a narrow band and do not differentiate between the different track construction types but by location; the values are reflective of typical limits for slab track systems globally. By specifying such close tolerances for track, this will reduce track fixity, compounding the misalignment risk and will reduce the life of the asset.

The maintenance limits defined are not reflective of the mechanisms of a ballasted track system, which will move under traffic – this is one of the basic functions as it dissipates load through vibration. Indeed, these limits appear more stringent than many construction tolerances for ballast track and therefore would be difficult to achieve at any point in the System's life. This was reflected in the survey values obtained in the 2020 RailPod survey. As such, it is not reasonable to define the track parameters in such a way unless other fixity measures are considered, such as “gluing” as referred to in the JBA Report (Clause 8.4).

If the intention is to retain the ballasted track in its current form, then the maintenance tolerances must be revised to reflect the inherent movement that will occur and define intervention limits accordingly.

A relevant example of Good Industry Practice in track maintenance is from the UK. The Network Rail Company Standards for Track Construction (NR/L2/TRK/2102) and Track Geometry Maintenance (NR/L2/TRK/001 Module 11) provide a level of differentiation between the two types of track construction: direct fixation or ballast. They provide construction and maintenance limits that align with those specified in the Confederation Line's Technical Standards & Maintenance document for direct fixation track, but also for different thresholds for ballasted track systems where larger tolerances are defined to reflect the reduced fixity of the system.

A periodic maintenance regime is implemented to ensure defects are addressed on a regular basis in order to prevent defects from propagating and affecting both ride quality and the track structure. Inspections by the maintainer will determine if further intervention is required in line with prescribed limits.

The requirement to maintain the ballasted track to such close tolerances will require interventions to be undertaken at a high frequency which will incur high costs and affect the economic viability of the System. Additionally, as ballasted track is realigned through mechanized “tamping,” this will result in breaking up the ballast at an accelerated rate, reducing the fixity of the track and reducing the life of the asset. It is therefore advised that the maintenance tolerances are reassessed to implement requirements for the differing track forms.

### **Management of clearances**

Taking into account the potential to relax maintenance interventions and allowances for greater track alignment tolerances, where ballasted track is located through clearance critical areas, such as platforms, it is reasonable to refine these tolerances, if necessary, and undertake more frequent maintenance in order to ensure track position is relatively stable or employ track stabilization. The Confederation Line employs spacers to maintain lateral tie position within station areas, so movement is unlikely.

This report has been developed under a privileged and confidential assignment on behalf of the City of Ottawa. While the report has been prepared for release to City Council as requested by the City and counsel to the City, neither the City nor its' counsel waive privilege over the overall assignment.

### 3.1.1.5 Length of Rail

The maximum permitted length of CWR track is defined in the Trackwork Design Brief, Section 3.2.5.1 as 500m. The JBA Report notes that there are only adjustment switches located on the Rideau River Bridge which would indicate that the 500m requirement has been exceeded throughout the route. This is reflective of Section 9.1.1 of the Trackwork Design Brief which refers to sliding rail expansion joints to counteract the thermal expansion of the structure.

In other parts of the world, this is not usually a consideration, not least when coupled with other mitigations as noted here and in the JBA Report. However, the compound and complex geometry and temperature ranges that the network operates within, will increase the risk of track buckling and installing adjustment switches in higher risk locations, meaning those locations where problems have already been observed, where there are complex combinations of geometry, changes of track type, etc., and so further intervention should be considered.

It is not desirable to install sections of jointed track as these introduce discontinuities into the rail which introduces impact loading into the track structure, increases maintenance burden, affects ride quality and rail performance. Mechanical joints are also still subject to thermal affects and will still be subject to closures and buckling in high temperatures and breakage from tensile forces in cold weather.

There is no specific assessment to determine the effectiveness of this system of risk mitigation and there are no standards governing this methodology so would require additional assessment if a similar arrangement were adopted on the Confederation Line System.

In the UK, maintenance teams in South Wales have adopted using adjustment switches (expansion joints) around complex geometry where this follows the alignment of the valleys. This is done to manage heat expansion in rails and reduce the risks of buckles, while not having to connect rails with mechanical joints. The methodology encompasses installing adjustment switches at either end of the curves with an additional adjustment switch located centrally in the curve.

Additionally, the specific function of the adjustment switch, with rails allowed to slide across each other, can have limitations in terms of the geometry it can be employed on. The sharp horizontal and vertical geometry will impact on the ability for the adjustment switch to function properly as rails will not be free to slide, and could also result in a very localized misalignment. It may, however, be possible to incorporate adjustment switches either side of tight radius curves, beyond the extents of any restraining rails.

It is worth noting that the joints at the Rideau River Bridge have not been installed in accordance with Good Industry Practice for design and construction. The inner blades should be pointed in the direction of traffic or primary traffic direction. Whereas the alignment of the components is the same on both tracks rather than reversed on each to suite primary traffic directions.



**Figure 3.7: Expansion joints installed in a “facing” position on the eastbound line**



Photo Source: Mott MacDonald

While this will not affect the function of the expansion joint directly, this does import increased risk of the asset being damaged with the thin end of the ‘blade’ being exposed to the impact forces from the passage of the wheels across the discontinuity in the track. This could result in reduction in effectiveness of the adjustment switch and accelerate maintenance interventions and renewals. A recommendation in this respect is provided in Section 4.

### 3.1.2 Switch Heaters

Previously it was noted that Project Co has proposed the following modifications to improve the operation of the switch heaters:

- Modification to duct arrangement and additional insulation to enhance performance of existing system and direct more heat to the critical areas, the heel blocks. The plan states that 16 switches have received modified duct work and all 26 mainline switches will be modified before next winter.
- SCADA monitoring issues were discovered, which meant that faults with the unit were not correctly reported. The plan indicates that work instructions will be written to dispatch crews to rectify this issue, and that switches will be cleared manually if required.
- It is understood that side nozzle adjustments have been undertaken to aim the nozzle at the web of the stock rail, directing more of the heat towards the heel blocks as intended.
- Options are currently being explored with regard to Heat Tracing and Crib Heating.
- Additional switch heater management protocols are also in progress, evaluating the benefit of switching the heaters on two to four hours prior to a snow event.

At the time of this report, the City has advised that the following works have been undertaken:

1. The following 12 switch heaters have been converted to higher powered gas heaters:
  - a. Conversion to natural gas:
    - i. Blair (four in total)
    - ii. Connector Track (three in total)
  - b. Conversion to propane (conversion to natural gas was to take place in 2021):

This report has been developed under a privileged and confidential assignment on behalf of the City of Ottawa. While the report has been prepared for release to City Council as requested by the City and counsel to the City, neither the City nor its' counsel waive privilege over the overall assignment.

- i. Connector Track (five in total)
2. All remaining electrical heaters between Tremblay Road and Tunney's Pasture (14 in total) have been upgraded and had heat tracers added.

These changes to the heaters and the other proposed mitigations do appear to have improved the situation, but at this time, it is not possible to validate that all of the concerns regarding switch heaters have been addressed.

### 3.1.3 Rail Corrugation and Rolling Contact Fatigue

Corrugation has been observed to be present by Mott MacDonald and by Project Co on both rails of the tight radius curves on the Confederation Line. Corrugation is the periodic wear of the rail surface into peaks and troughs. This uneven surface results in high forces between rail and wheel that increases the severity of the corrugation and can result in damage to both track and vehicle. Corrugation is unlikely to limit the availability of the vehicles in the short term but over extended durations the vehicles can experience cyclical loading that can introduce fatigue cracks which can impact safety. In addition, corrugation results in high levels of noise that can be a nuisance to neighbours and to passengers and staff on board trains who can also experience lower ride quality. The corrugation observed on the Confederation Line was found to be severe (greater than 0.5mm in places) after a year in passenger service. The corrugation is greater than the intervention limit of 0.25mm within the Project Co Track Maintenance Manual, RES-22-0-0000-MAN-0003, but is less than the limit of 1/8" (3.2mm) in the PA [Schedule 15-3 Maintenance and Rehabilitation Requirement, Appendix B, section 6(e), table 6.5.3B].

Project Co has contracted with a grinding contractor to undertake grinding of the affected sections of the Confederation Line and also with a consultant to provide expert advice in this regard. Grinding will remove the corrugation of the affected sections which will reduce the high forces and the potential impact on the track and vehicle. However, grinding the rail to the original profile will not prevent corrugation from forming in future and, given its previous rapid growth, it is likely to require grinding again soon. High growth rates of corrugation and frequent grinding will severely limit the life of the rail.

Associated with the corrugation at the same locations is the presence of rolling contact fatigue on the low rail. RCF is the initiation and growth of cracks on the rail head due to the contact forces between wheel and rail. If left untreated it is possible for cracks to propagate into the rail head and potential result in failure of the rail with the associated derailment risks for trains. In the early stages, RCF cracks can be removed by grinding, longer cracks can only be removed by rail replacement. As the RCF has been observed in the same locations as corrugation, given the limited time of operation of the Confederation Line, the grinding undertaken by Project Co should remove them as well. However, this should be confirmed post grinding through non-destructive testing.

Corrugation and RCF have formed after a short time period, less than one year of service operation, on the Confederation Line due to high wheel/rail contact forces. There are many potential causes for the high wheel/rail contact forces which are discussed in the following subsections. To understand the causes of corrugation and RCF on the Confederation Line, a detailed wheel/rail assessment is required to be undertaken so that solutions can be developed. This is also the conclusion reached by Advanced Rail Management (Canada) Inc. in their Pre-Grind Inspection and Post-Grind Report, Rev. 1, December 16, 2020; however, Project Co have not undertaken this further analysis.



### 3.1.3.1 Corrugation on Confederation Line

A summary of the corrugation on the System is presented below based on the Independent Review by Mott MacDonald as well as capturing comments made by representatives from the City of Ottawa:

- Corrugation is present on the low/inside rail of tight radius curves.
- The high/outer rail can have corrugation.
- Corrugation is predominantly present on ballasted track, with little or none reported on direct fixation track.
- No obvious trigger of corrugation (e.g., rail joints or welds).
- Little or no corrugation has been reported on tangent/straight track or shallow curves.
- Wavelength of corrugation is different between low and high rails.
- Low rail RCF, in the form of head checks, has been observed on the same curves as corrugation.
- No track side rail lubricators are installed.
- The ride quality of the vehicle is good on direct fix and on ballasted straight tracks and shallow curves but less than desirable on tight radius curves.
- All vehicles are of the same type, Alstom Citadis Spirit.
- The vehicle is fitted with on board sanding and flange lubrication equipment.
- CBTC/ATO is in operation.
- The on-board flange lubrication equipment is on a frequency, distance travelled, basis, not GPS location based. There have been observed issues with the maintenance of the on-board system in terms of incorrect alignment/adjustment of the flange lubrication spray nozzles, especially after post wheel truing when they are required to be adjusted accordingly. There have also been missing spray nozzles observed during our site visit.
- Damage to the truck mounted speed sensors and lubrication equipment has been experienced on the vehicles due to them becoming detached from their mounting locations.
- Corrugation has appeared within one year of the start of passenger operations (in September 2019), although vehicles had been operating over the tracks for testing, commissioning and driver training prior to the start of passenger service. Mott MacDonald first observed the extent of the corrugation when undertaking site visits in September 2020.
- The rail was ground in August/September 2019 for mill scale removal on the rail head (letter from the grinding contractor 21 December 2020).
- Further rail grinding has taken place in 2021 as noted elsewhere in this report.

Details presented in Table 3.1 on the locations with corrugation are developed by Mott MacDonald and taken from "Rail Corrugation on the Main Line," Garcia, M., Alstom, 2 October 2020.

**Table 3.1: Locations with Corrugation**

| Curve  | MM Location (m) | Corrugation Low Rail | Low Rail Wavelength (mm) | Low Rail Amplitude (mm) | Corrugation High Rail | High Rail Wavelength (mm) | Length (m) | Low Rail RCF | High Rail RCF |
|--------|-----------------|----------------------|--------------------------|-------------------------|-----------------------|---------------------------|------------|--------------|---------------|
| EB-210 | 104+725         | Yes                  | 50-75<br>75-100**        | 0.2                     | No                    |                           | 92         | Yes          | No            |
| EB-220 | 105+115         | Yes                  | 50-80                    |                         | Yes                   | 220-250                   |            | Yes          | No            |

This report has been developed under a privileged and confidential assignment on behalf of the City of Ottawa. While the report has been prepared for release to City Council as requested by the City and counsel to the City, neither the City nor its' counsel waive privilege over the overall assignment.

|        |         |              |                   |     |              |                           |     |        |
|--------|---------|--------------|-------------------|-----|--------------|---------------------------|-----|--------|
| EB-230 | 105+655 | Yes          | 110-130           |     | Yes          | 200>                      | Yes | No     |
| EB-240 |         | Yes          | 75**              | 0.4 | Not reported |                           | 125 |        |
| EB-280 |         | Yes          | 75**              | 0.4 | Not reported |                           | 74  |        |
| EB-330 | 108+685 | Not reported |                   |     | Yes          | Long and Short Wavelength |     |        |
| WB-210 | 104+725 | Yes*         | 50-75<br>75-100** | 0.3 | No           |                           | 87  | Yes No |
| WB-220 | 105+115 | Yes          | 50-80             |     | Yes          | 220-250                   |     | Yes No |
| WB-230 | 105+655 | Yes          | 110-130           |     | Yes          | 200>                      |     | Yes No |
| WB-240 |         | Yes*         | 75**              | 0.6 | Not reported |                           | 119 |        |
| WB-280 |         | Yes*         | 75**              | 0.4 | Not reported |                           | 85  |        |
| WB-330 | 108+685 | Not reported |                   |     | Yes          | Long and Short            |     |        |

Source: Mott MacDonald and Garcia, M.

\*The report from Alstom labels the corrugation for these curves as being present on the high rail which is not consistent with the information from the Mott MacDonald site visit.

\*\*The report from Alstom states the corrugation wavelength as “3/4inch” it is assumed that this means 3- to 4-inch and not 0.75-inch.

The depth of corrugation appears to be excessive considering the short time the System has been opened to traffic. The depth is greater than the maintenance intervention limit of 0.25mm in Chapter 3, section 3.4.5 of the Project Co Track Maintenance Manual, RES-22-0-0000-MAN-0003. It is, however, less than the intervention limit contained within the PA of 1/8” (3.2mm), [Schedule 15-3 Maintenance and Rehabilitation Requirement, Appendix B, section 6(e), table 6.5.3B]. In addition to the amplitude limit the PA requires corrugation to be controlled so that it does not result in “*track-based noise and/or vibration exceeding the limits imposed by City Bylaws or Schedule 17 of this Agreement.*” A “high-level” noise and vibration review was undertaken, and while the methodology was not strictly aligned with PA requirements, the review found that noise levels in exceedance of PA requirements are likely in the areas associated with the tight radius curves on the System, where corrugation is present. Further information is provided later in this section of this report.

The 1/8” limit in the PA is the same as that in the American Public Transit Association Rail Transit Track Inspection and Maintenance Standard APTA RT-FS-S-002-02, Rev. 1, 2017. The limit of 0.25mm will ensure that intervention will be carried out at a stage where corrugation is less likely to cause damage to track and vehicle than the PA limit; it is however greater than the limit used by London Underground of 0.08mm<sup>1</sup>. The Project Co maintenance document specifies that corrugation is to be monitored as part of the annual inspection, given that corrugation is, in places, greater than twice the intervention limit, it suggests that this frequency is insufficient. It does however have to be accepted that for most light rail systems annual inspection of corrugation would normally be sufficient to allow interventions to be made within acceptable timescales.

A review of the site visit photos has been undertaken; some examples are shown in the following figures with the features highlighted. It is not clear on which track the photos were taken, however, the site visit revealed that the features are similar on both tracks.

<sup>1</sup> London Underground, Track Handbook G-174, Managing the wheel/rail interface, June 2008

This report has been developed under a privileged and confidential assignment on behalf of the City of Ottawa. While the report has been prepared for release to City Council as requested by the City and counsel to the City, neither the City nor its' counsel waive privilege over the overall assignment.

Corrugation on the low rail is located near the crown of the rail, **Figure 3.8**, **Figure 3.9** and **Figure 3.11**. There is also wheel contact on the gauge corner and the gauge face shown by the shiny polished surface. In contrast, corrugation on the high rails extends from the crown of the rail through the gauge and down the gauge face in the form of periodic side wear **Figure 3.10** and **Figure 3.12**. **Figure 3.12**: Corrugation on High Rail of Curve 330 at 108+685 Figure 3.12: Corrugation on High Rail of Curve 330 at 108+685 shows two types of corrugation on the high rail, a long wavelength at the gauge corner with a shorter wavelength on the crown. There is evidence of plastic deformation occurring in the trough of the corrugation with plastic flow of the rail surface towards the field side away from the gauge corner, **Figure 3.9**. There is also some evidence of material breaking away “spalling” from the surface of the trough, **Figure 3.11**.

RCF in the form of head checks is present on the low rail on some curves, **Figure 3.8**, and **Figure 3.9**. No RCF is present on the high rail on the photographs examined.

There is evidence of engine or wheel burns on the head of the rail at one location, **Figure 3.14**; these occur due to wheel slipping on the rail locally heating the surface transforming the steel to a brittle phase. These can result in cracks initiating which can propagate down into the rail leading to failure if they are not managed. At the same locations are periodic shiny patches on the surface of the rail that seem to occur at similar wavelengths to the corrugation. This is likely to be white etching layer which is often formed on the surface of rail by the transformation of the surface due to a combination of plastic deformation and heating (but not sufficient to cause wheel burns)<sup>2</sup>. WEL are often present on corrugated rail but its role in the formation, if any, is unclear<sup>3</sup>.

Grease appears to be present on some curves, **Figure 3.10** and **Figure 3.13**, even though no track side lubricator is present, it is unclear if this is from the on board lubrication system or if it has been manually applied. Although the diagrams in the wheel flats report are not clear the locations with corrugation do not appear to be associated with low levels of adhesion<sup>4</sup>.

---

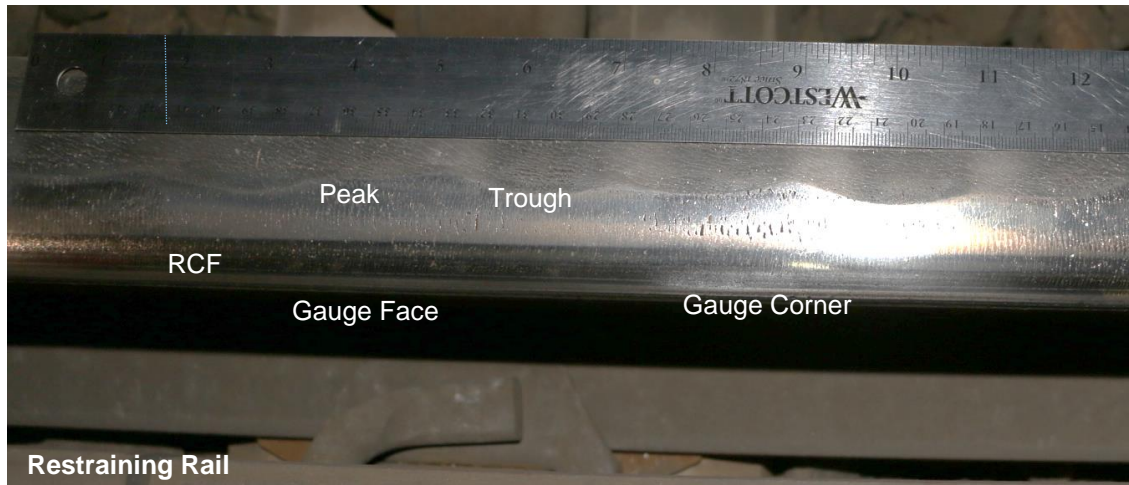
<sup>2</sup> W. Lojkowski, M. Djahanbakhsh, G. Burkle, S. Gierlotka, W. Zielinski and H. J. Fecht, 2001, Nanostructure Formation on the Surface of Railway Tracks, Materials Science and Engineering A, 303, (1-2), pp197-208

<sup>3</sup> G.Baumann, H.J.Fecht, S.Liebelt, 1996, Formation of white-etching layers on rail treads, Wear, 191 (1–2), pp133-14

<sup>4</sup> JBA, JBAUSA/RTM/023-04-04 1.0, Confederation Line Wheel Flats report, 4<sup>th</sup> June 2020

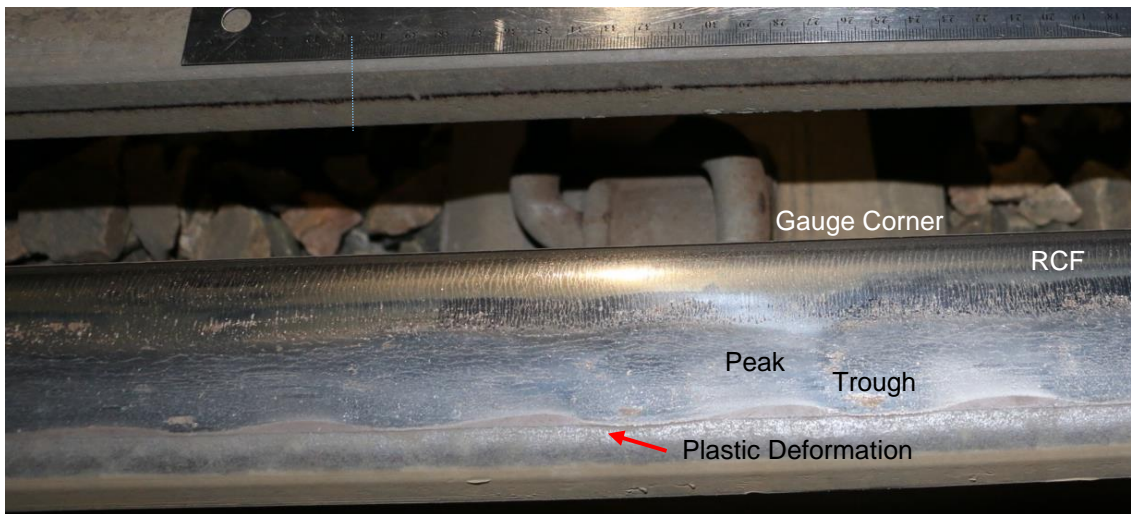
This report has been developed under a privileged and confidential assignment on behalf of the City of Ottawa. While the report has been prepared for release to City Council as requested by the City and counsel to the City, neither the City nor its' counsel waive privilege over the overall assignment.

**Figure 3.8: Corrugation on Low Rail of Curve 210 at 104+725**



Source: Mott MacDonald, IMG9014

**Figure 3.9: Corrugation on Low Rail of Curve 220 at 105+115**



Source: Mott MacDonald, IMG9041

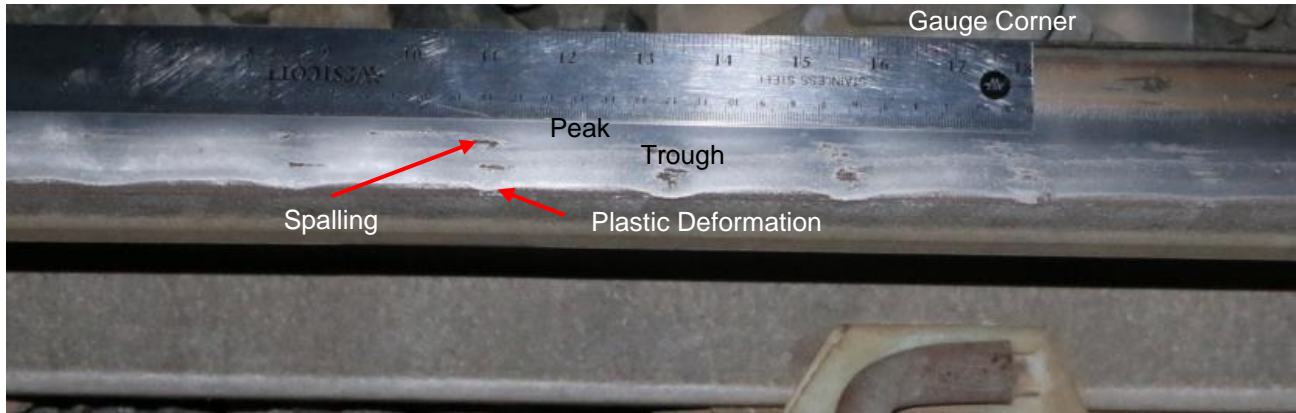
**Figure 3.10: Corrugation on High Rail of Curve 220 at 105+115**



Source: Mott MacDonald, IMG9031



**Figure 3.11: Corrugation on Low Rail of Curve 230 at 105+655**



Source: Mott MacDonald, IMG9047

**Figure 3.12: Corrugation on High Rail of Curve 330 at 108+685**



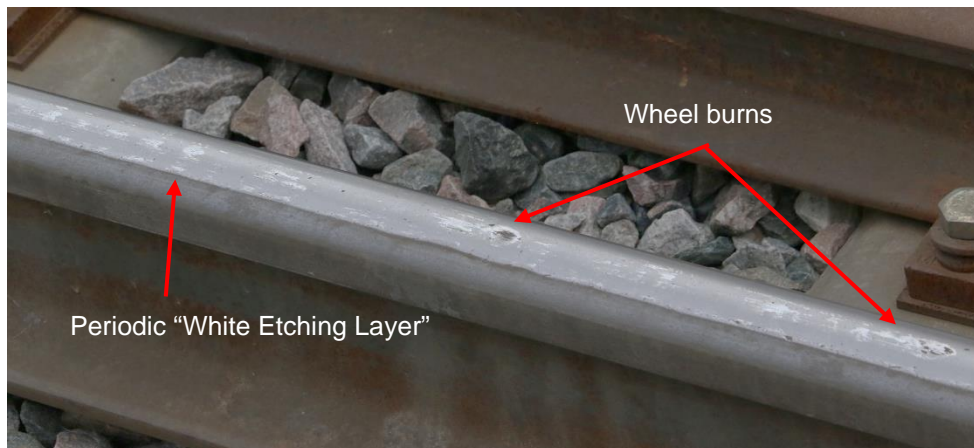
Source: Mott MacDonald, IMG9132

**Figure 3.13: Corrugation on High Rail of Curve 230 at 105+655**



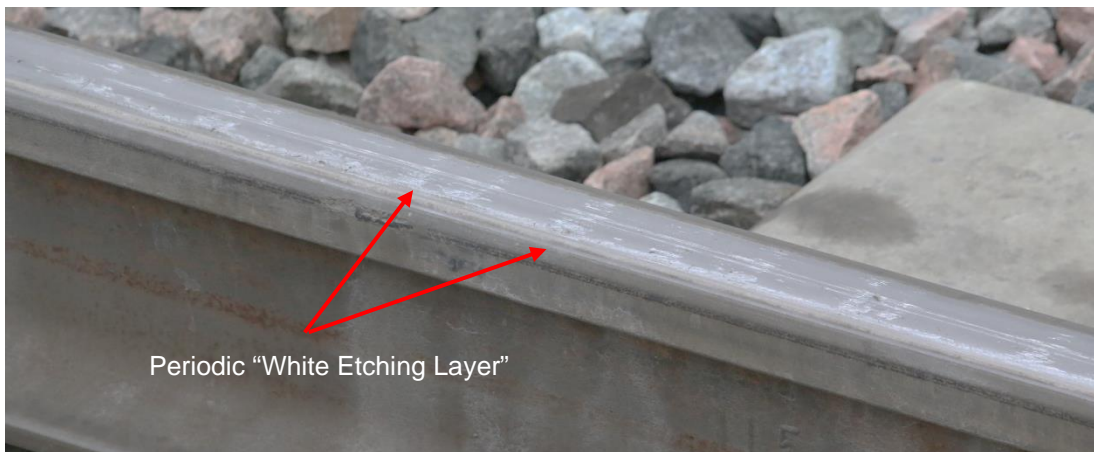
Source: Mott MacDonald, IMG9100

**Figure 3.14: Wheel Burns and Periodic Patches on Rail at Blair Terminus**



Source: Mott MacDonald, IMG8941

**Figure 3.15: Periodic Patches on Rail at Blair Terminus**



Source: Mott MacDonald, IM8943

Comparison of the locations in **Figure 3.16** with the noise and vibration monitoring undertaken by J.E. Coulter Associates Ltd. (J.E. Coulter Associates Ltd, Ottawa LT Confederation Line, Initial Light Rail Vehicle Interior Noise and Vibration Measurement Results, 10th January 2021) has been undertaken. Noise and vibration were measured on-board several vehicles along the length of the Confederation Line on both tracks. Due to the limitation on the measurement of vibration it is not possible to determine if the values are outside the allowable limits, but the measurements do highlight where passengers experience poor ride quality. The maximum allowable noise limits are given in the PA as follows [Schedule 15-2 Part 4 section 3.9]:

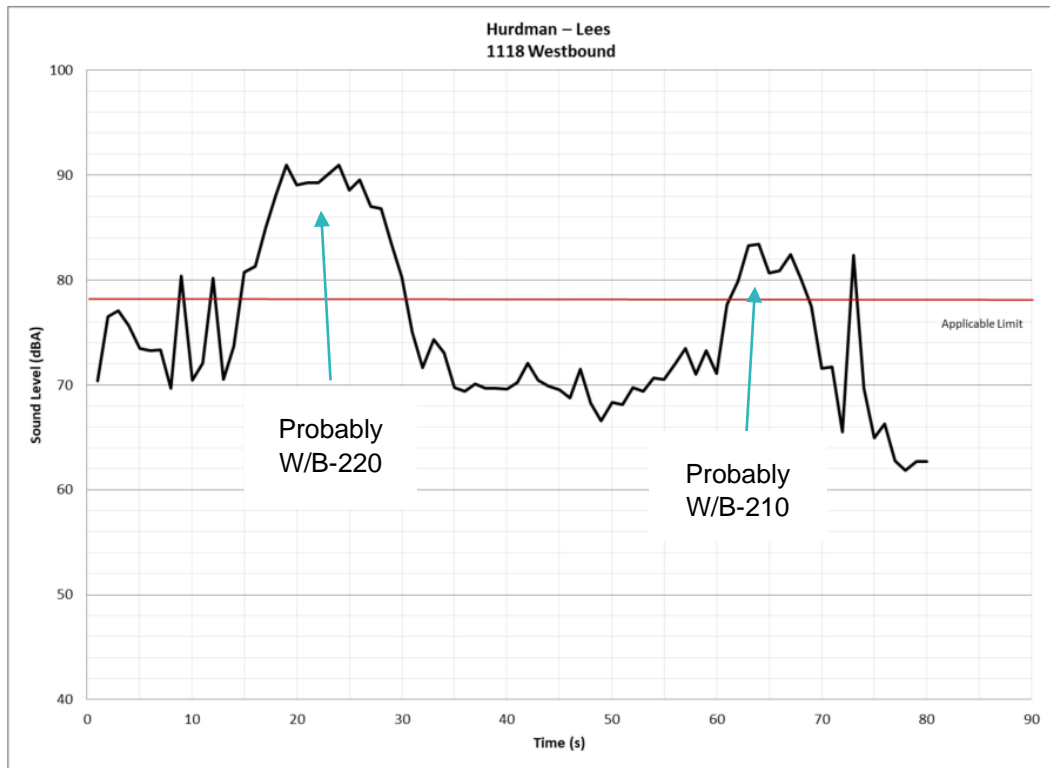
*a) Noise internal to the Vehicle shall be less than:*

*(i) 68dBA with the Vehicle stationary and all Equipment running in Revenue Service conditions;*

*(ii) 78dBA at Vehicle speeds up to 100km/hr; and*

*(iii) 80dBA in the Tunnel sections of the right of way, at Vehicle speeds up to 65km/hr.*

The noise results are summarized as plots against the time between stations, an example is shown in **Figure 3.16**. As the results are measured against time without knowing the exact speed of the train during measurements it is not possible to determine the exact locations where the noise exceeds the maximum allowable values. Calculating from the average speed given in the report it is possible to determine that many of the noise and vibration peaks that exceed the limit are likely to be associated with the tight radius curves on the System where corrugation is present. The highest noise level measured is 91dB (exceeding the limit of 78dB) on the westbound track between Hurdman and Lees is likely to be associated with curve W/B-220. The locations with high noise levels also show high values of vibration.

**Figure 3.16: Noise Measurement between Hurdman and Leeds for Westbound track**

Source: J.E. Coulter Associates Ltd, Ottawa LT Confederation Line, Initial Light Rail Vehicle Interior Noise and Vibration Measurement Results, 10th January 2021,

Based on the above observations, the approach to understanding the corrugation on the Confederation Line has been to undertake an Independent Review of the track and vehicle design information and compare with Good Industry Practice regarding maintenance of track condition, to highlight areas where further investigation is required. This Independent Review highlighted areas that could potentially be a reason for the corrugation; however, the cause is likely to be a combination of two or more reasons, due to the complex nature of wheel/rail interaction. A detailed wheel/rail interaction study is ongoing, and will help understand the formation of corrugation to determine if the correct wheel and rail profiles are being used.

### 3.1.3.2 Rolling Contact Fatigue

RCF is the progressive cracking of the running surface of the rail due to repeated contacts from the wheels. There are several forms with the most common being “head checks”, which the Project Co Track Maintenance Manual, RES-22-0-0000-MAN-000, Chapter 4, section 4.5.2 defines as follows:

*“Head checks are recognizable as fine surface cracks occurring continuously at more or less regular intervals. These cracks are situated, seen from above, at an angle of 35-70 degree to the longitudinal axis.”*

RCF forms due to the wheel/rail contact stresses being greater than the yield stress of the rail resulting in plastic deformation of the rail surface. The rail can only be deformed to a certain

This report has been developed under a privileged and confidential assignment on behalf of the City of Ottawa. While the report has been prepared for release to City Council as requested by the City and counsel to the City, neither the City nor its' counsel waive privilege over the overall assignment.



extent before its ductility is exhausted resulting in the initiation of cracks at the surface. Cracks typically form at 90° to the applied forces between wheel and rail. Under certain conditions RCF cracks can grow and lead to rail failure and potentially be a cause of derailment.

Observations of the photos from the site visit by Mott MacDonald has shown that RCF cracks are present on the surface of the low rail, **Figure 3.17** and **Figure 3.18**. There appears to be two forms of cracks on the rail, transverse cracks near to the gauge corner which are closely spaced and in places have joined up with material “spalling” from the surface. There are also secondary longitudinal cracks nearer to the crown associated with the location where the corrugation is present. The two forms of cracks and the running bands indicate that wheels are contacting the rail in two different places. One near the gauge corner where the contact forces are predominantly along the length of the rail and the second contact near the centre of the rail head where the forces apply transversely to the rail.

RCF on the low rail of curves are usually shallow and rarely propagate sufficiently to jeopardize the integrity of the rail. RCF on the high rail is more of a concern as the contact forces are more likely to promote crack growth. Most railway networks manage RCF through the monitoring of cracks, only carrying out interventions when they reach a critical depth. It is therefore vital to monitor the growth of cracks, through visual inspection and non-destructive testing, so that interventions can be made when required. Where cracks are shallow the rail can be ground or milled to remove the cracks to prevent them from growing.

Regular grinding to control corrugation will also have the beneficial affect of removing any RCF cracks before they grow to a significant extent. For longer cracks grinding can be used to remove the wheel contact from the crack location to prevent them from growing but it will be difficult to completely eliminate them. With appropriate inspection to monitor any further growth, RCF cracks can remain in track. However, the only way to eliminate them is rail replacement. Recommendations on management of the RCF on the Confederation line are made in section 3.1.3.5.

The Project Co Track Maintenance Manual, RES-22-0-0000-MAN-000, Chapter 4, section 4.5.2 Covers “Head Checks” as follows:

*Head checks are recognizable as fine surface cracks occurring continuously at more or less regular intervals. These cracks are situated, seen from above, at an angle of 35-70 degree to the longitudinal axis. The cracks penetrate into the interior at increasingly steep angles. Therefore, Head Checks have to be assessed as dangerous track defects.*

*Please refer to Appendix 1 “Maintenance and Operation Manual for LRT Special Trackwork by London Trackwork Inc.” for remedial action for such defect.*

Appendix 1<sup>5</sup>, section 9, page 56, requires visual inspection to be carried out every six months or every 5MT of traffic with ultrasonic inspection carried out if required. Grinding is to be carried out as soon as head checks appears where cracks are less than 15mm on the surface. If cracks are longer than 15mm then rail replacement is required. It also states that grinding should be undertaken shortly after installation and periodically. It should be noted that this part of the appendix states that it is for turnouts with heat treated rail, with no requirements for standard rail or plain line track.

The visual inspection and remedial measures for head checks are different to the criteria in the ATPA standards which are required to be followed by the Project Agreement, Schedule 15-3

---

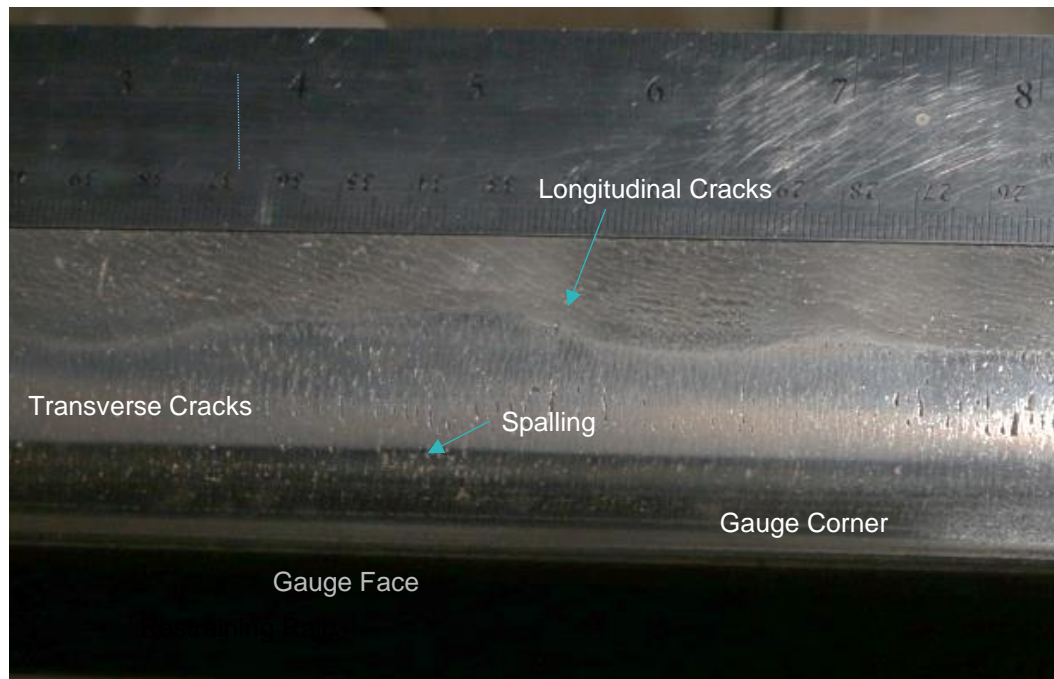
<sup>5</sup> London Trackwork Inc., Manual for maintenance and operation for LRT Special Trackwork, Rev 3, 12th March 2015

This report has been developed under a privileged and confidential assignment on behalf of the City of Ottawa. While the report has been prepared for release to City Council as requested by the City and counsel to the City, neither the City nor its' counsel waive privilege over the overall assignment.

Maintenance and Rehabilitation Requirement, Table 6.5.3B for all rail defects. The PA also states that Transport Canada Track Safety requirements are required to be followed.

The APTA standard Table 11A, requires intervention based on percentage of the railhead cross sectional area weakened by the defect which are relevant to ultrasonic inspection but provides no details for visual inspection<sup>6</sup>. Project Co's minimum actions are however in line with the practices adopted by Network Rail<sup>7</sup> on the extensive UK mainline network where RCF is initially characterized by surface crack length until ultrasonic or eddy current measurements are undertaken.

**Figure 3.17: Rolling Contact Fatigue on Low Rail of Curve 210 at 104+725**

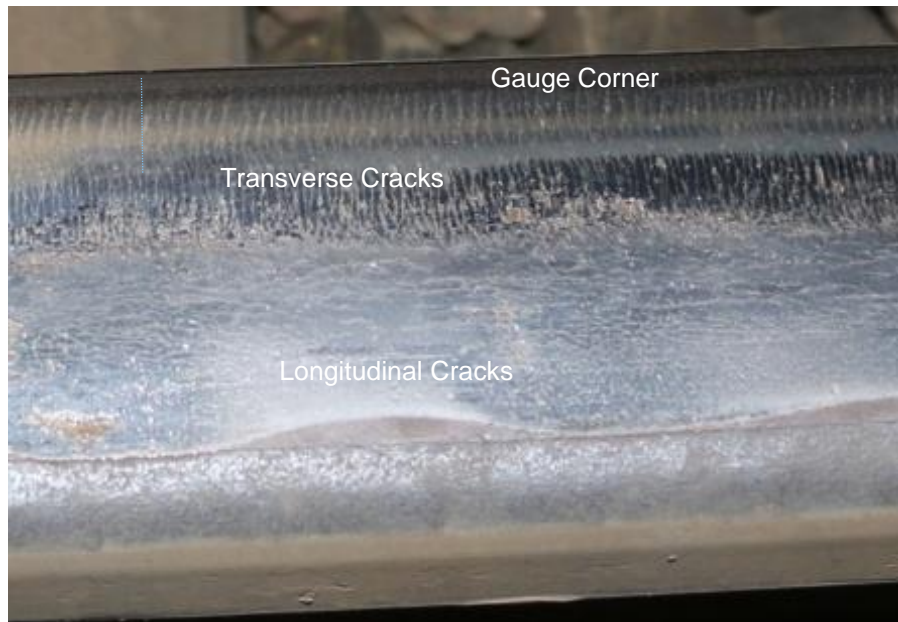


Source: Mott MacDonald, IMG9014

<sup>6</sup> APTA Rail Transit Track Inspection and Maintenance Standard, APTA RT-FS-S-002-02, Rev. 1, 2017

<sup>7</sup> Network Rail, Inspection and Maintenance of Permanent Way, NR/L2/TRK/001 Issue 12, 1<sup>st</sup> September 2019

This report has been developed under a privileged and confidential assignment on behalf of the City of Ottawa. While the report has been prepared for release to City Council as requested by the City and counsel to the City, neither the City nor its' counsel waive privilege over the overall assignment.

**Figure 3.18: Rolling Contact Fatigue on Low Rail of Curve 220 at 105+115**

Source: Mott MacDonald, IMG9041

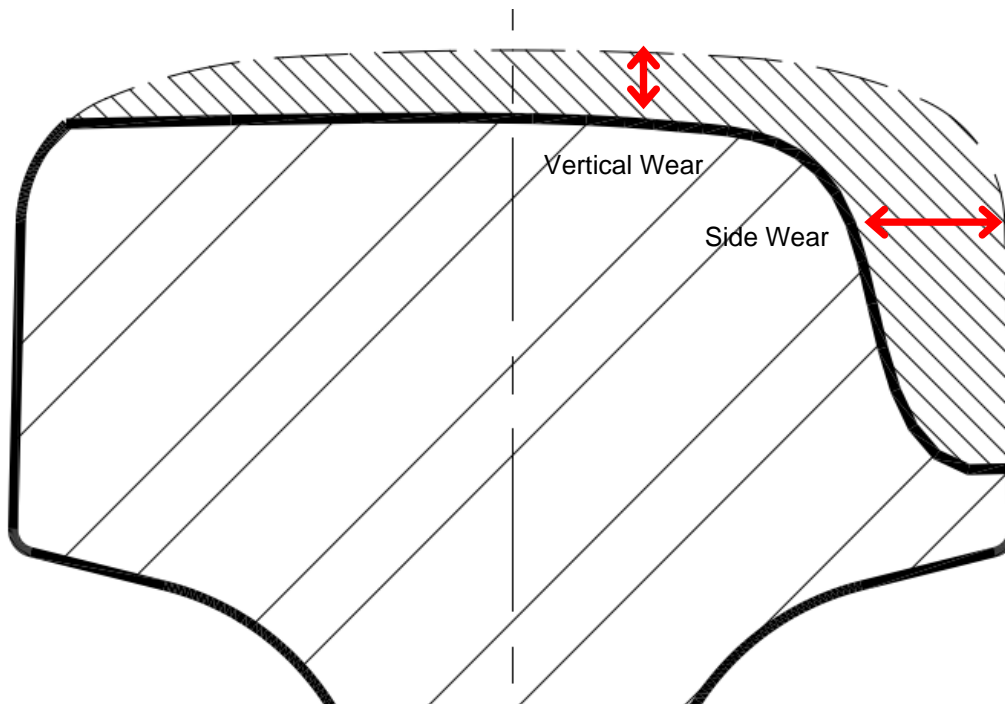
Wheel burns (sometimes referred to as engine burns), **Figure 3.17**, occur on the surface of the rail due to wheel slipping in the rail, they are often present on both rails at the same location and occur due to the increase in temperature resulting from friction. The high temperatures allow the surface layer of the rail to transform to a brittle phase which can initiate cracks within the rest of the rail. Although wheel/engine burns are not a form of RCF, they can lead to transverse cracks developing leading to rail failures. Therefore, the management of them is similar with visual and non-destructive inspection required to understand the length and depth of them to determine what further actions need to be undertaken.

Chapter 4, section 4.5.14 of the Project Co Trackwork Maintenance Manual states that “at early stages wheel burns can be repaired by resurfacing, otherwise a short section of rail minimum 4.5 m long (“plug rail”) should be installed.” The APTA standard, table 11C, requires wheel burns to be replaced within 24 hours with no mention of weld repair or resurfacing. In contrast, Network Rail allow wheel burns with no ultrasonic indication of transverse defect into the rail to remain in track and can be weld repaired rather than the rail replaced.

### 3.1.3.3 Rail Wear

Rail wear (and wheel wear) is an inevitable process that occurs due to the contact forces between wheel and rail. Wear will lead to the requirement to replace the rail at some point in the future and it is vital to understand the wear rates to allow planning of renewals prior to the rail reaching a wear limit. These are set, along with other reasons, to ensure that the rail still has integrity to withstand the loads of trains at the end of its life.

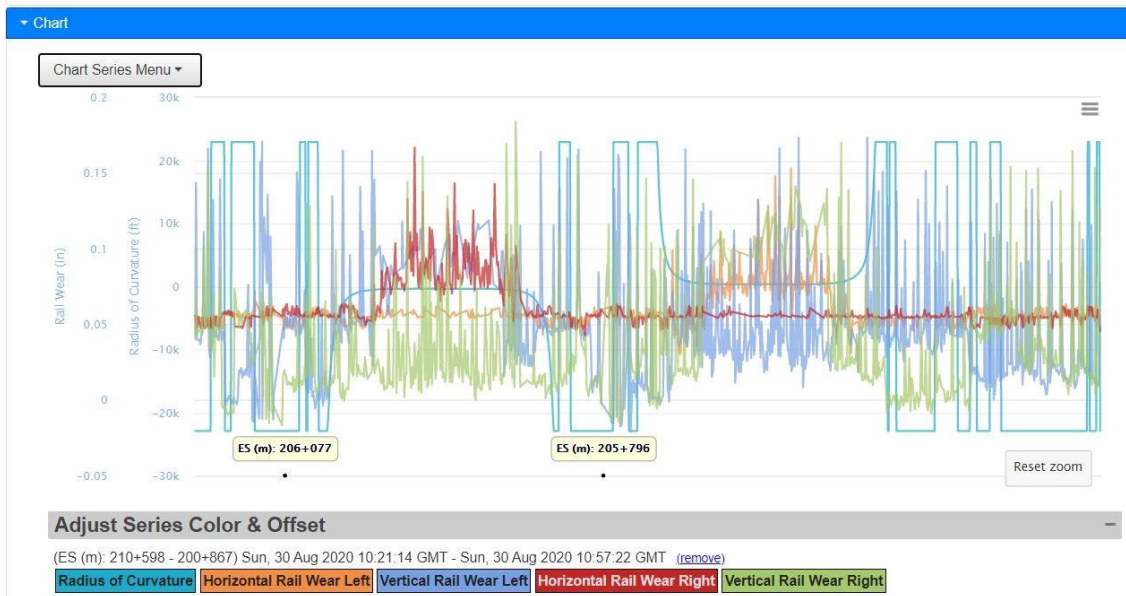
The PA sets wear limits of 5/8” (15.9mm) vertically and horizontally (side wear). (**Figure 3.19: Schematic of Rail Wear**) Project Co Trackwork Maintenance Manual (RES-22-0-0000-MAN-000) gives limits of 12mm vertical and 9mm for side wear which are much less than maximum recommended limits in the APTA standard.

**Figure 3.19: Schematic of Rail Wear**

Rail wear has been measured by the RailPod inspection using lasers mounted to the vehicle. This has undertaken measurements for every metre on the whole route, the results can be compared to the track curvature and other parameters, **Figure 3.20** Figure 3.20: RailPod Wear Plot for Westbound Hurdman Curves WB-240 and WB-230 gives an example for the Hurdman reverse curves. This shows that both vertical and side wear are greater on the curves compared to the straight track, however, there is a wide variance in the wear on the curves. The reason for this is that the laser measurement requires visibility of the rail web and foot to allow the measured profile to be accurately aligned against the reference profile. The restraining rail present on the low rail of the tighter radius curves prevents measurement below the head. Example profiles of curved track are shown in **Figure 3.21** (the right rail is the low rail) and tangent track in **Figure 3.22** Figure 3.22: RailPod Rail Profiles Tangent Track 205+805 .

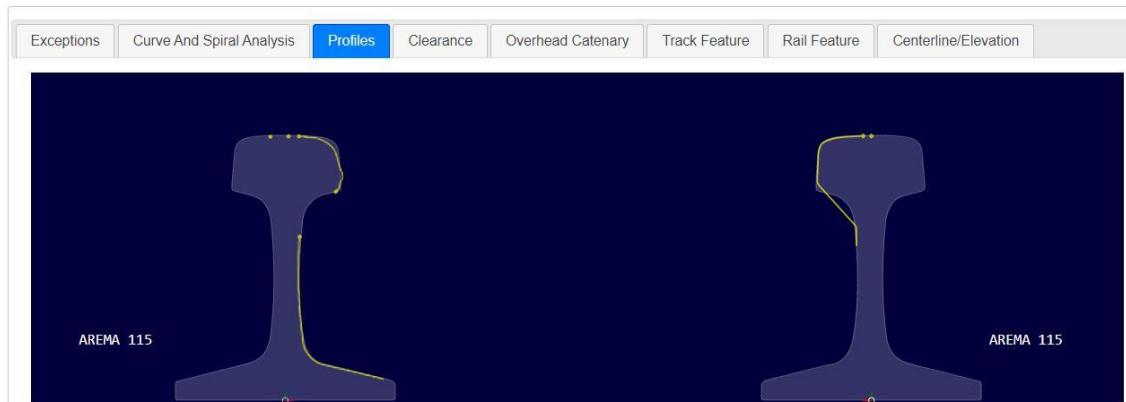
Due to this issue with the measurement manual filtering of accurate measurements have been made for the majority of curves and selected tangent sections, the results are plotted against curve radius in **Figure 3.23** Figure 3.23: RailPod Vertical Wear against Curve Radius for vertical wear, **Figure 3.24** and **Figure 3.25** for side wear. Tangent track is shown at 7000m.

Figure 3.20: RailPod Wear Plot for Westbound Hurdman Curves WB-240 and WB-230



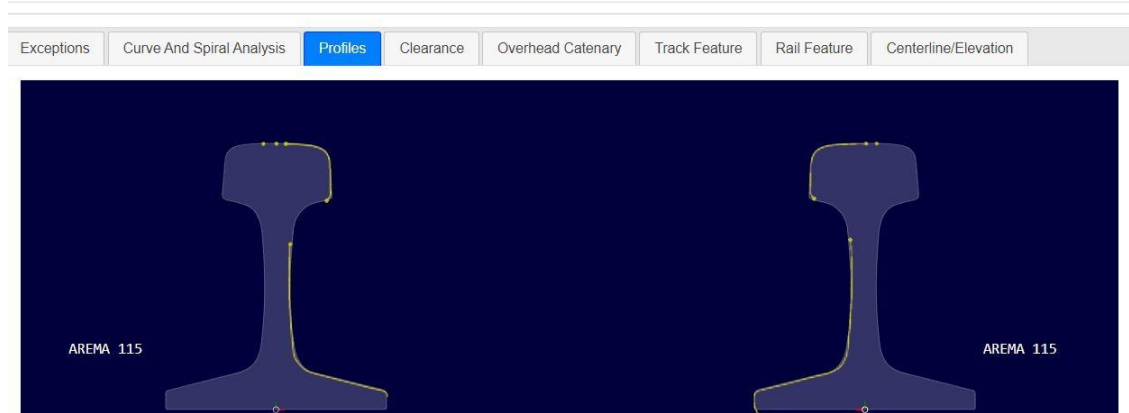
Source: Mott MacDonald

Figure 3.21: RailPod Rail Profiles Curve WB-240 205+928



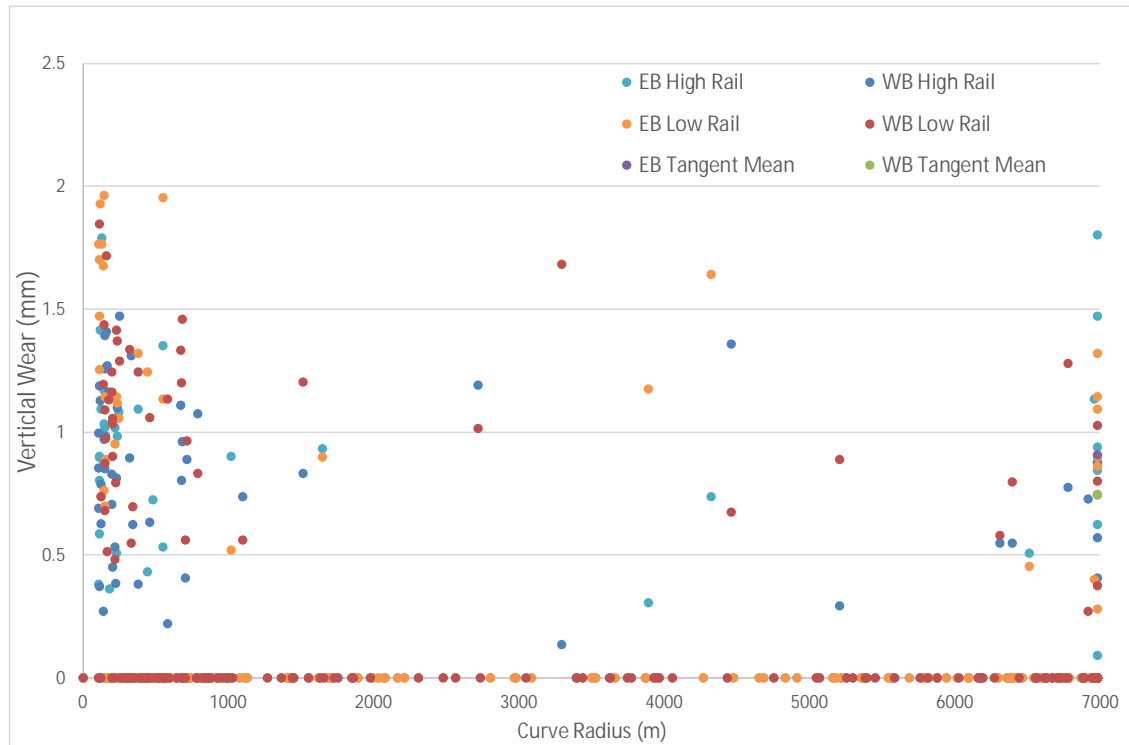
Source: Mott MacDonald

Figure 3.22: RailPod Rail Profiles Tangent Track 205+805



Source: Mott MacDonald

Figure 3.23: RailPod Vertical Wear against Curve Radius

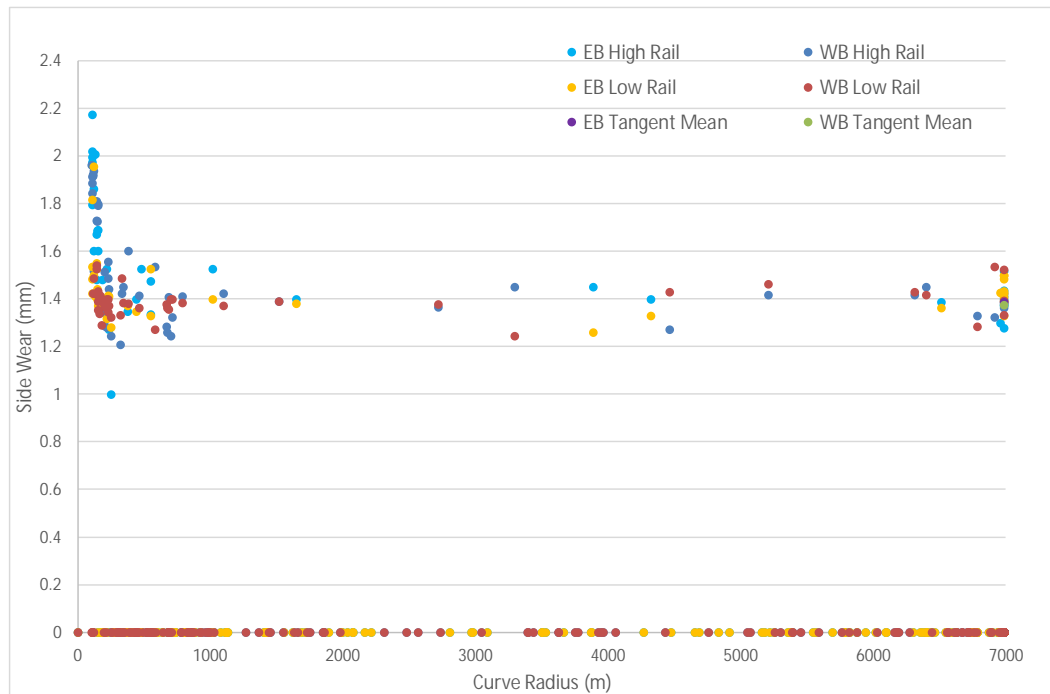


Wheel burns

Source: Mott MacDonald

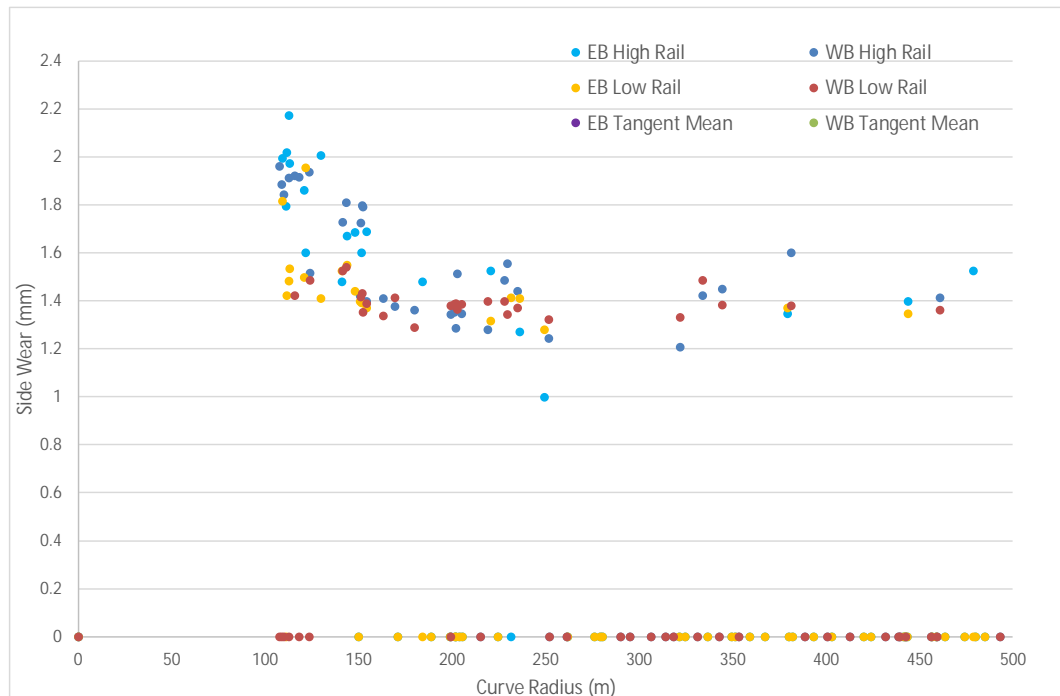


**Figure 3.24: RailPod Side Wear against All Curve Radius**



Source: Mott MacDonald

**Figure 3.25: RailPod Side Wear against Curve Radius Less than 500m**



Source: Mott MacDonald

The vertical wear of the rail shows wide variance between 0.5mm and 2mm with no obvious trend with curve radius. In contrast, side wear is greater on the tighter radius curves compared to shallow curves and tangent track. This is especially pronounced for the high rail where it is

This report has been developed under a privileged and confidential assignment on behalf of the City of Ottawa. While the report has been prepared for release to City Council as requested by the City and counsel to the City, neither the City nor its' counsel waive privilege over the overall assignment.

around 0.5-0.7mm greater. Even on the low rail of the tightest curves there is a slight increase of 0.1-0.2mm, **Figure 3.25**. The reason that side wear on tangent track is not zero and the large spread in vertical wear is probably due to the manufacturing tolerance of the rail and measurement error.

All measured wear is much less than the wear limits and is of values expected for a system of the age of the Confederation Line.

#### 3.1.3.4 Discussion

Corrugation on the Confederation Line had formed to an extent which is considered excessive after 12 only months of passenger service, as observed by Mott MacDonald in September 2020. It has been observed on the sharpest curves on the ballasted track sections of the mainline, predominantly on the low rail with some on the high rail. The wavelength of corrugation is different between the low and high rails which is reasonably common for metro systems<sup>8</sup>. The locations where corrugation is present are close to the locations where noise values, measured on board the trains, are greatest and exceed the allowable limits

The corrugation that has been measured has a depth with a maximum of 0.6mm, this is greater than the maintenance intervention level of 0.25mm in the Project Co Track Maintenance Manual; it is however, less than the maximum allowed by the Project Agreement of 1/8" (3.2mm), although this does appear large considering the damage corrugation can cause. The PA also includes requirements around noise and vibration arising from corrugation, but Mott MacDonald are not aware of any detailed measurements against strict PA requirements having been undertaken.

A review of the track alignment and construction design has been undertaken and has not revealed anything that is likely to be the sole cause of corrugation. The alignment of the track has been designed for ride comfort by ensuring that the lateral acceleration is lower than the maximum permitted by the PA. This however does mean that the unbalanced super elevation is also low and is likely to result in poor steering of the vehicle around the sharpest curves on the System which could contribute to the formation of corrugation. This is especially true as the actual speed that trains are travelling at are lower than the design speed resulting in actual unbalanced super elevation being less than 25% of the values in as built drawings. Details on the rail pad are unknown but could potentially result in the ballasted track being more susceptible to corrugation due to higher stiffness, although the likely cause is the tighter radius curves present on the ballasted sections compared to the DFF track.

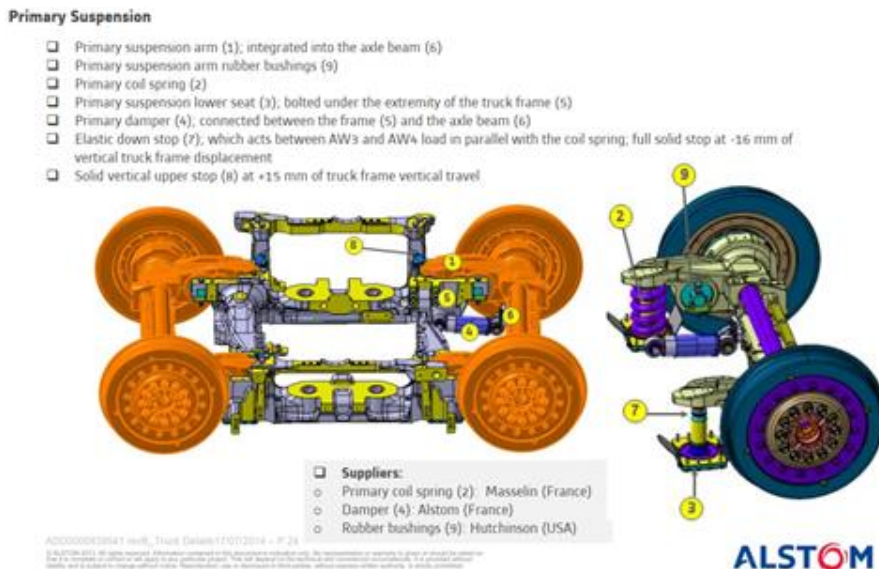
The design of the vehicle, especially the vehicle truck and wheel, has been reviewed and has raised some concerns that the vehicle may possibly be poor at steering around tight radius curves. The construction of the truck is not of a conventional type and has the potential to have high primary yaw stiffness and truck rotational resistance, although no values are available, which could result in poorer than typical steering. The truck has a high axle load and may also have high levels of un-sprung mass which would increase the damage to the rail. The wheel profile has been designed to provide a compromise between steering on curves and stability on straight track. Further assessment of the known derailments in the MSF, mentioned earlier in this report but not yet reviewed in depth, may support these concerns.

---

<sup>8</sup> Oostermeijer, K.H., Short pitch rail corrugation -cause and contributing factors, World Congress on Railway Research (WCRR) 2006, Montreal, Canada

This report has been developed under a privileged and confidential assignment on behalf of the City of Ottawa. While the report has been prepared for release to City Council as requested by the City and counsel to the City, neither the City nor its' counsel waive privilege over the overall assignment.



**Figure 3.26: Information from Second Design Review for Truck Primary Suspension**

Source: Alstom, ADD0000939541 Rev B, 2nd Pre-Final Design Review Truck Details

A review of the wheel/rail videos has shown that on the curves where corrugation is present the leading axle of the motor truck is offset to the outer side of the curve with the wheel flange in contact with the high rail gauge corner. Although not visible, the trailing axle on the truck is likely to be offset the other way with the flange in contact with the low rail gauge corner. The running bands and the different RCF cracks on the low rail provide evidence for this, **Figure 3.17**. With the leading axle offset to the high rail, the low wheel contacts the crown of the low rail where the corrugation is located, the forces appear to be towards the field side shown by the longitudinal cracks and evidence of plastic flow in the corrugation troughs. The contact on the high rail is at the gauge corner with high contact forces resulting in corrugation and side wear, **Figure 3.10**, and **Figure 3.25**. The trailing wheel set is offset to the inside of the curve resulting in flange contact on the low rail resulting in no corrugation on the gauge corner but transverse RCF cracks forming, **Figure 3.17**, and small levels of side wear, **Figure 3.25**.

The truck orientation through the curve results in a high angle of attack between the leading axle and the rail, resulting in high contact forces and hence, rail damage. The presence of two bands of corrugation with different wavelengths on E/B-330 and W/B-330 curves, **Figure 3.12**, provides further evidence for the difference in wheel/rail contact between axles on the same truck. With the gauge corner wear and corrugation likely to be produced by the leading axle and the corrugation on the crown of the rail by the trailing axle.

The reason the damage is in the form of corrugation is likely to be because of the change in wheel/rail contact forces as the leading wheelset tries to steer its way around the sharp curves by the wheel flange repeatedly contacting and moving away from the high rail in a “crabbing” motion.

It is unclear why the wavelength on the high and low rail are different but may be due to two different mechanisms of formation, e.g. the difference between wheel/rail contact of the trailer and motor trucks. This would also explain why high rail corrugation is only present on a few of the curves with low rail corrugation, and on one curve where no low rail corrugation appears to be present.

This report has been developed under a privileged and confidential assignment on behalf of the City of Ottawa. While the report has been prepared for release to City Council as requested by the City and counsel to the City, neither the City nor its' counsel waive privilege over the overall assignment.

## 3.2 Rail Systems

### 3.2.1 Overhead Catenary System

#### 3.2.1.1 Parafil Rope

Parafil rope is used in several OCS assemblies, typically wire terminations, headspans, pull-offs, cantilevers, and droppers. Reported failures of the Parafil rope cantilever top tie resulted in the contact and catenary wires dropping, causing delays in service operations.

Project Co carried out an investigation of the failures and concluded that arcing across the Parafil rope was a contributory factor to the failure mode of the Parafil ropes and has been provided with the following recommendations from their own OCS Arcing Task Force:

- Inspect all Parafil rope terminations for excessive corrosion or signs of wear.
- Parafil ropes that have previously been replaced should have their rubber sleeves removed to inspect for corrosion penetration.
- Immediately replace all Parafil ropes near roadworks with the as-is design.
- Replace all Parafil ropes with a design using manufacture recommended sealed termination.
- Keep a photographic record of condition with a date stamp.
- Regular, ongoing maintenance inspections enhanced in advance of winter.
- All Parafil shall be cleaned, as per the maintenance manual.

The rectification work was to be carried out over a 10-month period, starting in April 2020 and completed by January 2021, with key areas being complete in July 2020. The construction phase was due to be completed between May and November 2020.

In fact, we understand that the rectification work on the main lines was carried out: 09/05/2020 to 16/05/2020 and 21/06/2020 to 28/06/2020.

Project Co has not provided a report on the incident or any detailed reports on the rectification work they have carried out or to why work was not completed in the MSF.

Once all the rectification work has been completed as proposed, the likelihood of a failure of the Parafil rope will be significantly reduced.

#### 3.2.1.2 Rigid Rail

Rigid rail is used to provide support for the contact wire that the pantograph runs along. On the O-Train system, the rigid rail consists of short (10m–12m) lengths of extruded aluminium sections that are fixed together using bolted plates. Where the rigid rail ends, the contact wire is continued for a short section and bent upwards to enable a smooth passage of the pantograph from one section to another.

A failure occurred where the contact wire was ripped out of the rigid rail; however, no report giving the extent of the damage incurred has been provided. Project Co carried out an inspection of the rigid rail and their maintenance practices and concluded that the incident was caused by regular repair and maintenance where shunt straps had been temporarily attached to the tail of the contact wire.

The solution adopted was to change the O&M procedure for the application of shunt straps in rigid rail locations.

To date no evidence has been received by Mott MacDonald to show that Project Co's proposals stated within the Rectification Plan have been carried out. However, should the

This report has been developed under a privileged and confidential assignment on behalf of the City of Ottawa. While the report has been prepared for release to City Council as requested by the City and counsel to the City, neither the City nor its' counsel waive privilege over the overall assignment.

recommendations be adopted to install shunt strap fixing brackets on the rigid rail, then there will not be any similar incidents.

### 3.2.1.3 Pantograph Integration

The power to the LRV is taken from the OCS by means of a pantograph. The pantograph slides along the underside of a contact wire, which causes wear on both the carbon strips of the pantograph head and the copper contact wire. In order to create even wear over the length of the carbon strips, the contact wire is staggered on either side of the centre line of the track.

The carbon strips on the vehicle pantograph have significant groove patterns, indicating that the contact wire has ridden along the same location for an extended amount of time and chipping along the edges, consistent with striking hard spot in the OCS, such as runners on section insulators.

Project Co carried out several surveys and concluded that there are locations pertaining to the OCS alignment that will benefit from adjustment to allow for more stagger, specifically in the rigid rail sections.

Several recommendations from the submitted surveys to Project Co by their OCS Arcing Task Force included:

- Full system inspection of the areas highlighted by the survey
- Prioritization of arcing points related to insufficient stagger
- Adjustments required to improve stagger
- Repair any deficiencies found during inspection

The rectification work to the OCS were carried out during the two system shutdowns, refer to section 3.2.1.1, with only rectification work carried out on the mainline OCS. Project Co provided an updated height and stagger survey taken during the rectification work. A review of the data and analysis of the RailPod survey data is provided in section 3.2.1.5.

A detailed scope of work was not developed or included in the Rectification Plan master schedule or before the work was to be carried out. The proposal to inspect on site and rectify as necessary appears adequate for the type of modifications required, as long as documented and verifiable inspection criteria can be established. Based on the survey information, it is recommended that Project Co prescribe the changes to be made to the OCS and ensure the as-built information meets the Project design criteria.

Based on the results of the review, the changes made will improve the performance of the pantograph-to-OCS interface; however, they may not prove to be the final solution to the issue of excessive wear on the pantograph carbons.

As noted in section 3.2.1.1, the wear on the carbons appears to be more even, and carbons are generally only being replaced due to chipping/cracking, however, the frequency of change due to damage is unknown which could mean that they are being replaced more frequently, therefore grooving may not have time to develop to the level seen previously. It was evident from the videos provided, both before and after the rectification work, the introduction of speed limits, and the site visit that many section insulators required some adjustment to provide a smooth transition from one side to the other. The Rectification Plan did not address this issue, and the modifications carried out under the plan will not necessarily resolve the problem.

The wear along the arc horns of the pantograph is due to the scraping of the crossover/turnout contact wires. Whilst it can be expected that some wear may occur, the degree of the wear appears excessive, based on our experience of other similar systems. From the video, site visit,

and RailPod data, it is evident that some of the crossover/ turnout wires are set either set too low or too high adjacent the mainline OCS and should be adjusted accordingly.

#### 3.2.1.4 Initial Document Review Findings

##### **Alstom Infrastructure Facility Inspection**

In addition to the three main items of concern to the City, several other issues were found during the initial Alstom review and details provided in the Infra Facilities Inspection presentation dated January 27, 2020. The following is a summary of the issues raised by Alstom:

- Pantograph
  - Abnormal wear
  - Premature wear and grooving of carbon strips
  - Damage on pantograph horns
- Overhead Conductor Rail
  - Sagging of the contact wire
  - Excess of grease
  - Arcing at overlaps
  - No earth connections to steel support
  - Corrosion rigid rail due to ingress of water

##### **Alstom Infrastructure Review**

Based on the recommendations of the Infra Facility Inspection report, in February 2020, Alstom carried out a height survey of the OCS contact wire, using their measurement and diagnostic module Catenary Tracer and documented their results in a second report, Ottawa Heights and Stagers, dated June 4, 2020, reference HUB-0.0-M700-ALS-000-00009, revision 0.

The conclusions from Alstom's report are:

- The contact wire height variations are not necessary and advise to maintain an average height on the same section so as not to cause fatigue of the mechanical components of the installation and thus prevent the risk of tearing off.
- The nominal height of the contact wire of the flexible catenary should be on the whole line, excluding obstacle zones, set at 4.50 metres and 4.20 metres for the rigid catenary in tunnels.
- The stagger of the contact wire is irregular and does not allow the correct wear on the pantograph carbon and should be correctly set over the entire line.
- Regarding the various other risks, identified in the January 2020 report, e.g., failure of insulators and Parafil ropes, wearing of the pantograph when crossing over the transition zones, electric arcs, etc., a complete inspection of the OCS should be carried out by catenary expert.

Mott MacDonald agrees with the Alstom's conclusions and although no type of data analysis was prescribed, Project Co's height and stagger report would have been more complete if additional analysis had been carried out to:

- Compare the design heights and staggers to those measured, which, given the design to be correct, would further highlight errors in installation.
- Determine if the as-built OCS had been installed within allowable construction tolerances specified in Schedule 15-2 Part 4 to the Project Agreement, Article 8, Section 8.5 (a).

This report has been developed under a privileged and confidential assignment on behalf of the City of Ottawa. While the report has been prepared for release to City Council as requested by the City and counsel to the City, neither the City nor its' counsel waive privilege over the overall assignment.

- Determine if the contact wire was within the minimum and maximum allowable design or working heights of the pantograph, ref Schedule 15-2 Part 4 to Project Agreement, Article 8, Section 8.16 (a).
- Assess the contact wire gradient in accordance with design criteria, ref Schedule 15-2 Part 4 to Project Agreement, Article 8, Section 8.5 (c).
- Provide a pantograph security analysis to determine the maximum allowable staggers.

### Incident Logs

To determine if any trends in failures in the OCS were occurring, Project Co's incident logs from September 2019 to August 2020 were examined. Although there were no recurring issues, 22 OCS incidents of note were identified, of which two could have a significant effect on the operation of the System should the incident escalate:

- Counterweights, appearing to be either too high or too low, which could result in a change in tensions in the messenger and contact wire, if the weight hit the lower and upper stops at their extreme temperature ranges. This could cause damage to the OCS and or pantograph or a dewirement.
- Jumper wires disconnected from the contact wire, which could be hit or snagged by the pantograph, resulting in damage to the OCS and or the pantograph.

#### 3.2.1.5 Heights and Staggers

Analysis of the height and stagger information provided in the as-built documents (ref: WS-5666 - PS&D - OCS - Mainline & MSF Lead Tracks - As-Builts Combined\_A) was carried out.<sup>9</sup>

### Contact Wire Height

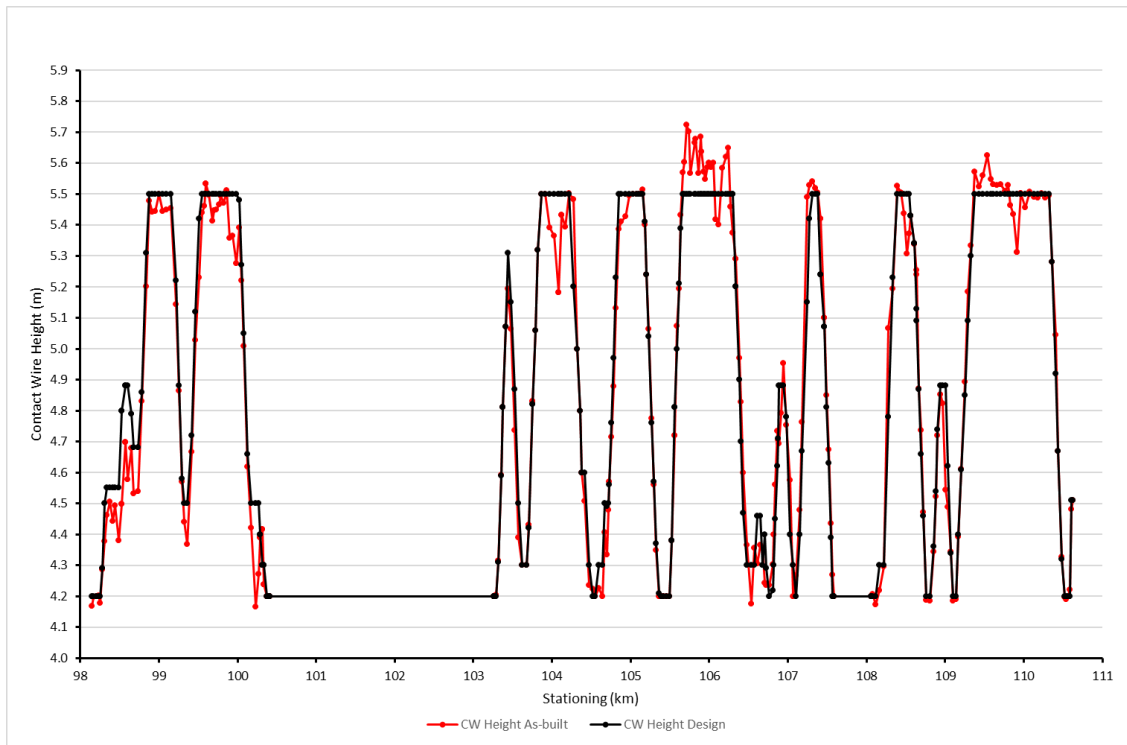
Contact wire heights were reviewed in both the eastbound and westbound directions. **Figure 3.27** is provided to show graphically the eastbound contact wire heights (and is a reasonable proxy for the similar westbound representation). The as-built profiles (in red) are typical to those presented in the Alstom report.

---

<sup>9</sup> Note: there was no data included in the documents for the overhead conductor rail ("OCR") sections of the route.

This report has been developed under a privileged and confidential assignment on behalf of the City of Ottawa. While the report has been prepared for release to City Council as requested by the City and counsel to the City, neither the City nor its' counsel waive privilege over the overall assignment.

**Figure 3.27: As-built v Design Contact Wire Height – Eastbound Track**

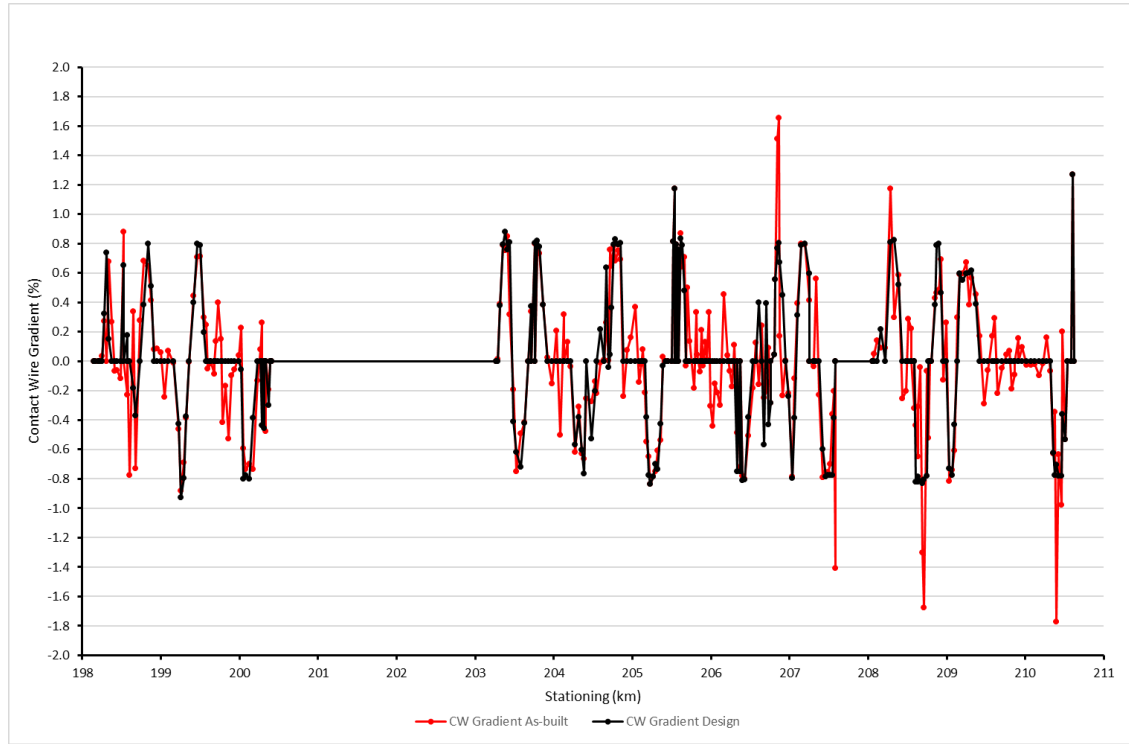


It is noted that the contact wire heights may have been adjusted on site during construction due to other infrastructure as-built conditions, for instance at or near tunnel portals or overhead municipal bridges. Based on PA Schedule 15-2 Part 4 Article 8, there are a number of locations that do not meet the installation tolerance of -13 mm to + 25 mm, for open route sections. Note data for the tunnels sections was not available at the time of the analysis.

**Contact Wire Gradient**

Contact wire gradients were also reviewed in both the eastbound and westbound directions. The contact wire gradient for the westbound track is shown graphically in **Figure 3.28**, and is a reasonable proxy for the findings for the eastbound track. The allowable design grading for both eastbound and westbound tracks (ref CAN/CSA C22.3 No. 8-M9, as per Table 4-8.5 in PA Schedule 15-2 Part 4 Article 8, Section 8.5 (c) (i)) is replicated in Table 3.2.

**Figure 3.28: As-built v Design Contact Wire Gradient - Westbound**



**Table 3.2: Maximum Contact Wire Gradients**

| Speed           | Maximum Contact Wire Gradient               |
|-----------------|---|
| Yard (15 km/hr) | 2.3% (1:43), Storage and Maintenance Tracks |
| Yard (30 km/hr) | 2.0% (1:50), Yard Lead and Loop Tracks      |
| 50 km/hr        | 1.3% (1:77)                                 |
| 75 km/hr        | 0.8% (1:125)                                |
| 100 km/hr       | 0.6% (1:167)                                |

Source: Schedule 15-2 Part 4 to Project Agreement, Article 8, Section 8.5 (c) (i)

Based on the maximum allowable design gradient for the main line of 0.8%, it can be seen in **Figure 3.29** and **Figure 3.30** that there are areas where the design and as-built contact wire grading does not meet the requirements of the Project Agreement Schedule 15-2 Part 4, Article 8. The implications of excessive grading can be either a reduction or increase in the contact force on the pantograph, which can lead to:

- Local accelerated wear of the contact wire
- Loss of contact, causing arcing
- Accelerated wear of the pantograph carbons
- Chipping of the pantograph carbons

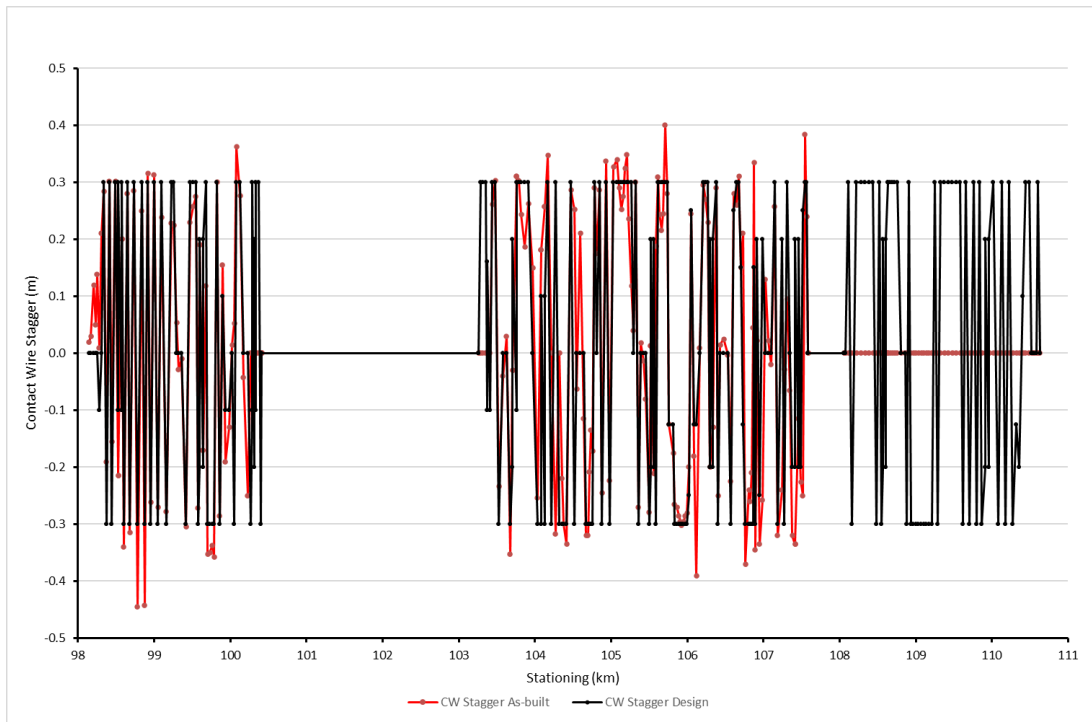
**Contact Wire Stagger**

The as-built contact wire stagger for both the eastbound and westbound tracks were compared with the design and are shown graphically in **Figure 3.29** and **Figure 3.30**.

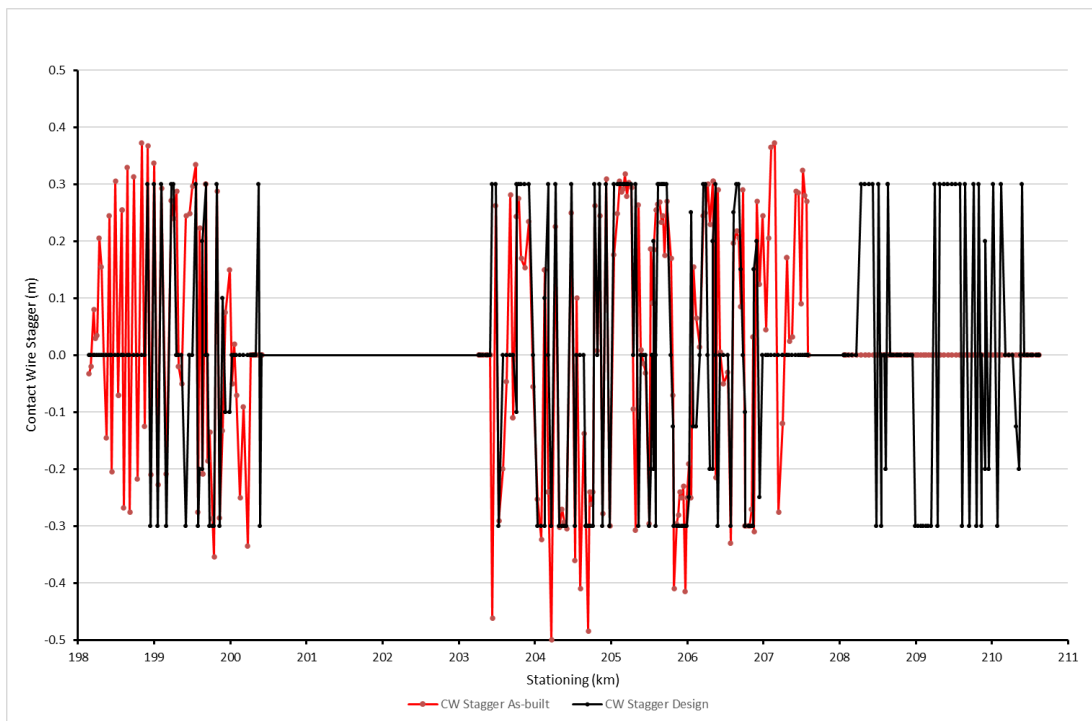
This report has been developed under a privileged and confidential assignment on behalf of the City of Ottawa. While the report has been prepared for release to City Council as requested by the City and counsel to the City, neither the City nor its' counsel waive privilege over the overall assignment.



**Figure 3.29: As-Built v Design Contact Wire Stagger – Eastbound Track**



**Figure 3.30: As-built v Design Contact Wire Stagger – Westbound Track**



Based on PA Schedule 15-2 Part 4 Article 8, there are a number of locations that do not meet the installation tolerance of -25 mm to + 25 mm. This has resulted in the staggers being either smaller or greater than the design and could affect the contact wire/pantograph interface. Note the as-built and design values for the tunnel sections were not available at the time of the analysis and has not subsequently been provided.

This report has been developed under a privileged and confidential assignment on behalf of the City of Ottawa. While the report has been prepared for release to City Council as requested by the City and counsel to the City, neither the City nor its' counsel waive privilege over the overall assignment.



### 3.2.1.6 Modified Contact Wire Design Heights Stagers

#### As-built Data Review

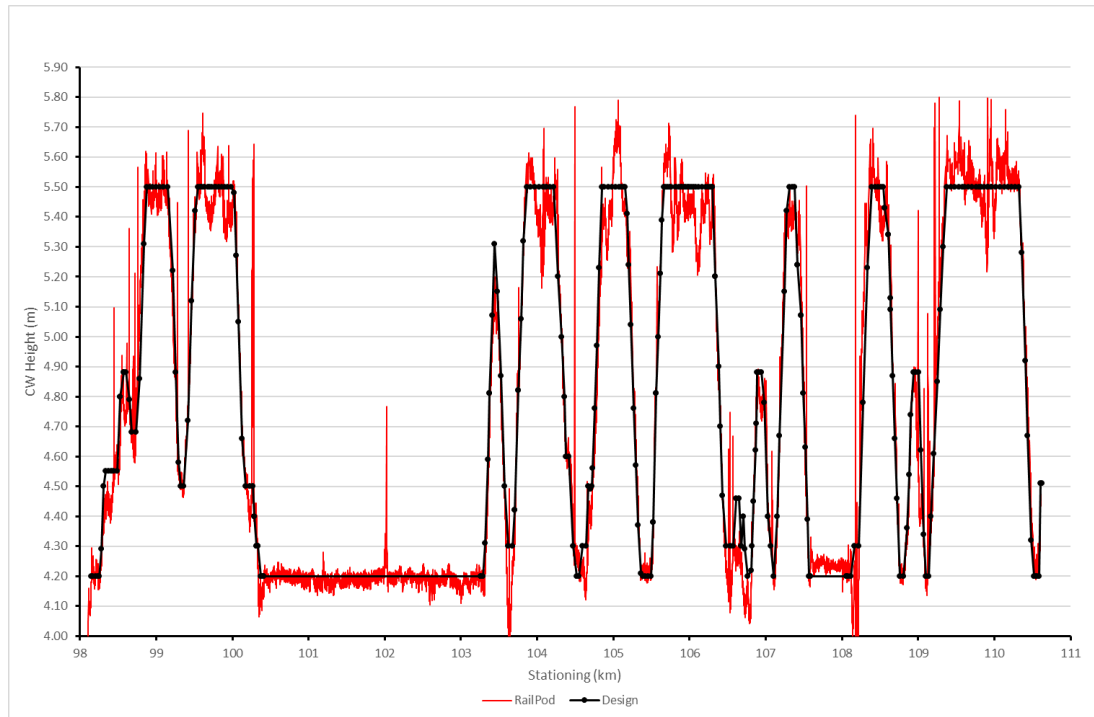
Project Co provided a list of heights and staggers measured after carrying out modifications on the main lines in accordance with the Rectification Plan for sections S1 to S4. The height and staggers were not provided for section S5, so it is not possible to carry out an analysis or make any determination.

A comparison of the new heights and staggers to those provided at the as-built stage of the Project was carried out and is presented in Volume 7 with the change in values highlighted. Note that some of the changes are minor and may be due to inherent errors in measurement or, in the case of staggers, due to cantilever movement caused by temperature changes.

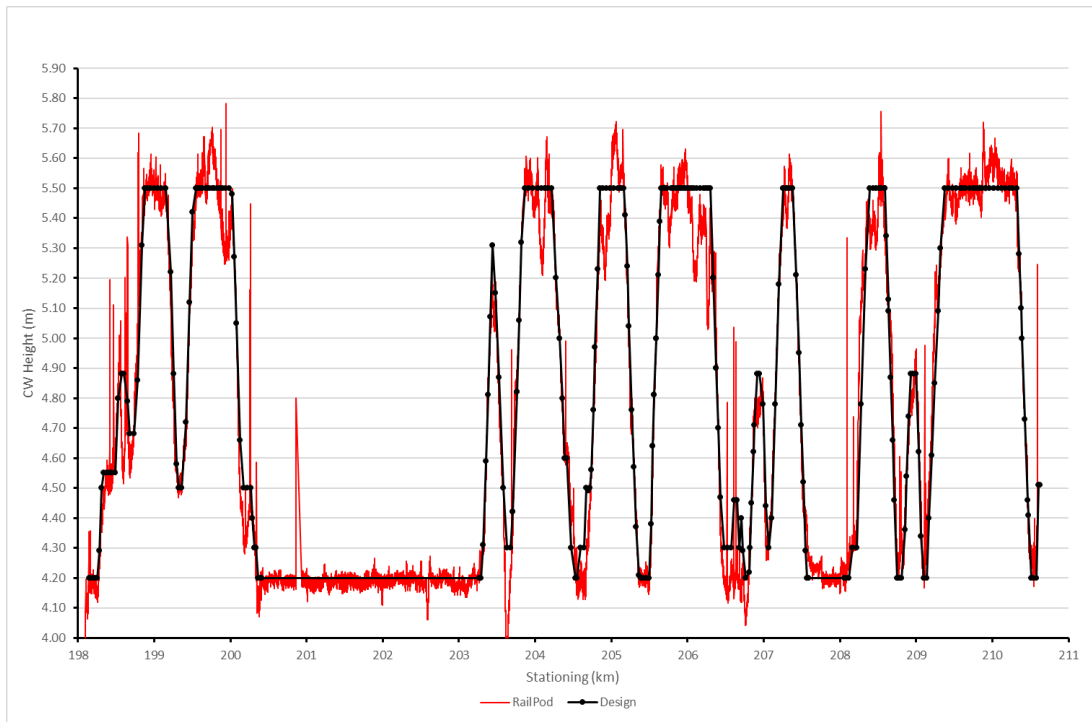
A comparison of the RailPod contact wire height data, measured in September 2020 and part in February 2021, for both the eastbound and westbound tracks, was compared to the Project Co design, similar to that in section 3.2.1.5 and are shown in **Figure 3.31** and **Figure 3.32**. Note that some spikes occur as shown within the RailPod data due to gaps in the OCS or potentially due excessive movement of the measuring machine and can be disregarded.

Based on the new as-built data, after the modifications had been carried out, and the RailPod survey, it is evident that the overall OCS has been improved and that, at these locations, the contact wire heights and grading are more in line with the design. However, there are still a number of locations that do not meet the grading or tolerance requirements, as specified in PA Schedule 15-2 Part 4, Article 8. And so, while the risks listed above may have been reduced, it is not possible to say that they have been brought into alignment with PA requirements.

**Figure 3.31: RailPod Data V Design Contact Wire Height for Eastbound Track**

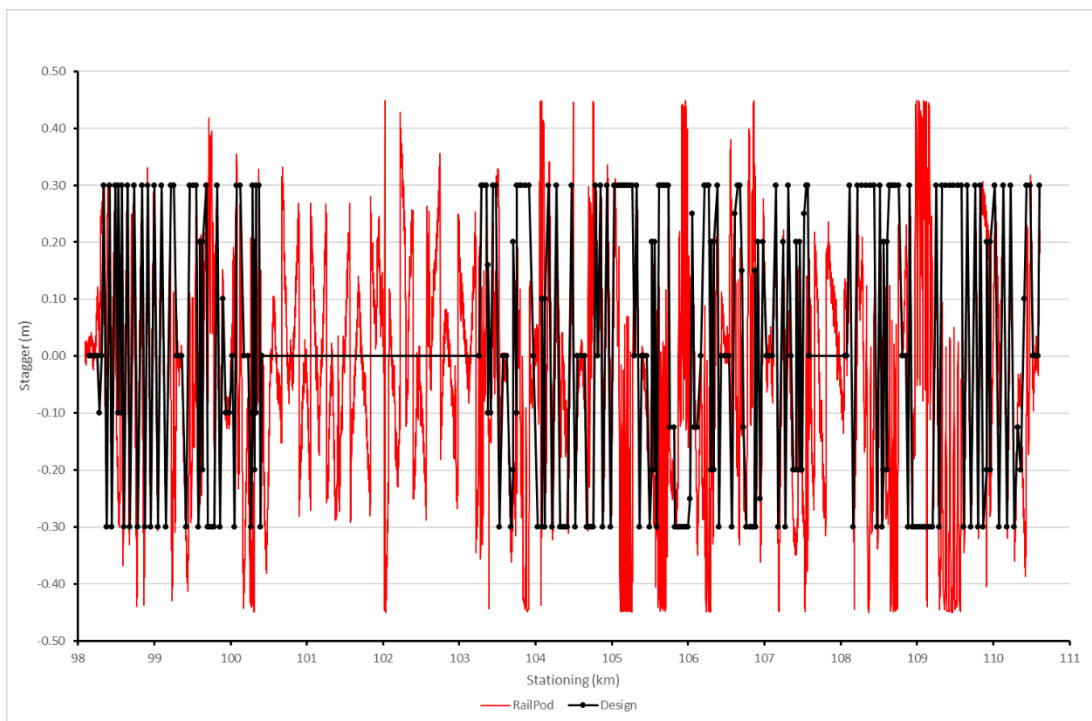


**Figure 3.32: RailPod Data v Design Contact Wire Height for Westbound Track**

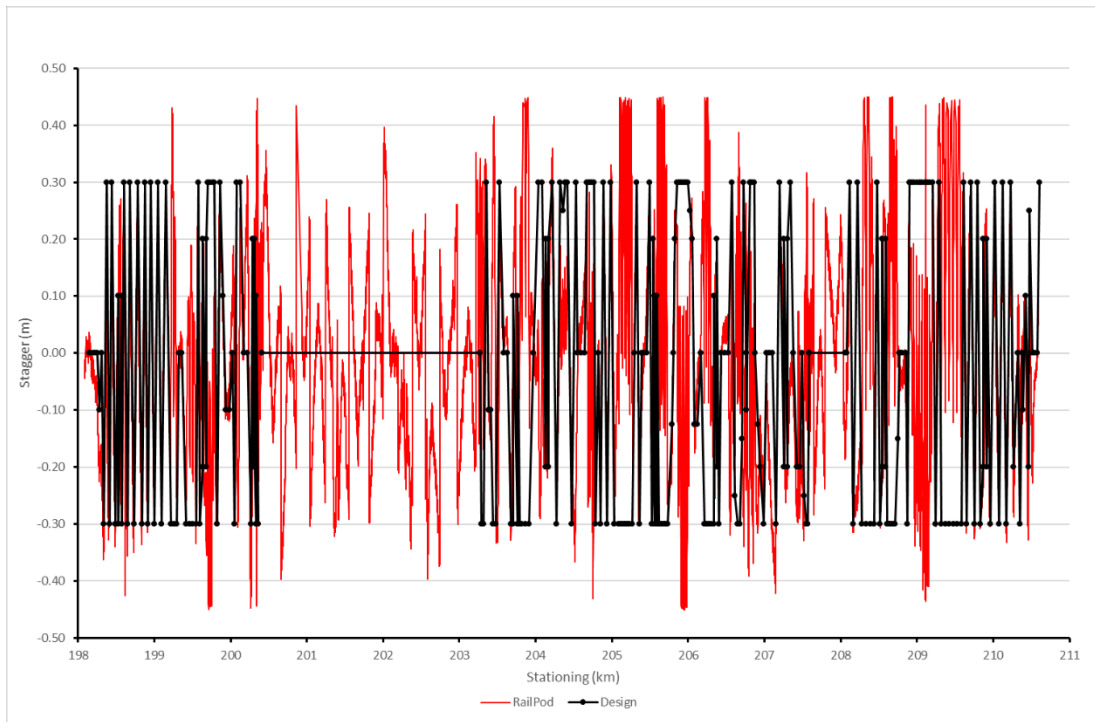


A similar exercise was carried out using the RailPod data for the stagger of the contact wire and is shown graphically in **Figure 3.33** and **Figure 3.34**.

**Figure 3.33: RailPod v Design Contact Wire Stagger – Eastbound Track**



**Figure 3.34: RailPod v Design Contact Wire Stagger – Westbound Track**



It can be seen on the basis of the charts provided that there is an overall improvement of the OCS, but again, there are still a number of locations that do not meet the requirements of PA Schedule 15-2 Part 4, Article 8.

### 3.2.1.7 Crossovers and Turnouts

Observations have shown that the pantograph horn is hitting the contact wire at crossovers and turnouts, causing undue wear **Figure 3.35**.

**Figure 3.35: Wear on Pantograph Horn**



Photo source: Mott MacDonald

In addition, there is a risk, with extreme temperature ranges experienced in Ottawa and the potential of additional ice loading, that the pantograph could hook-over the crossover contact wire and cause major damage to the OCS and pantograph including:

This report has been developed under a privileged and confidential assignment on behalf of the City of Ottawa. While the report has been prepared for release to City Council as requested by the City and counsel to the City, neither the City nor its' counsel waive privilege over the overall assignment.

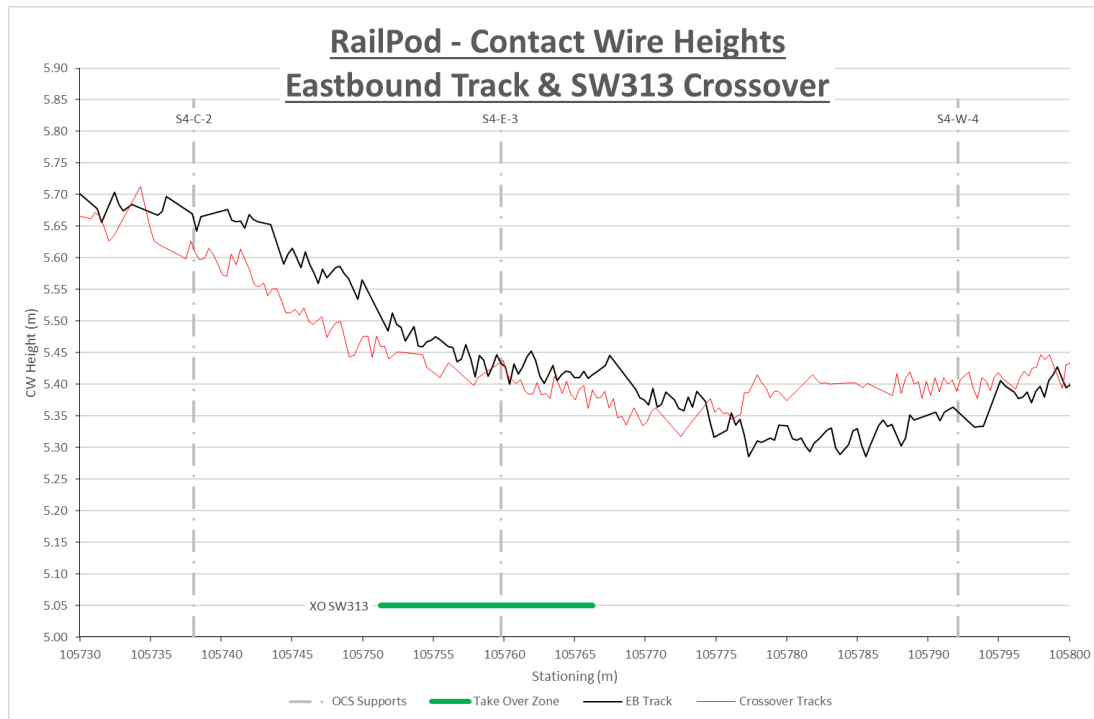
- Broken/bent cantilevers
- Contact and messenger wire ripped down and or broken
- Damaged or broken dropper and jumper wires
- Broken/deformed pantograph head and arm assemblies

To reduce the likelihood of a hook-over occurring, and consistent with Good Industry Practice in LRV maintenance, the contact wire heights should be checked and adjusted as a part of regular ongoing LRV maintenance activities, to ensure the correct take-over as the pantograph traverses the wires.

Additionally, tests with a pantograph with painted horns would help validate whether the issue remains after proposed remedial measures have been undertaken.

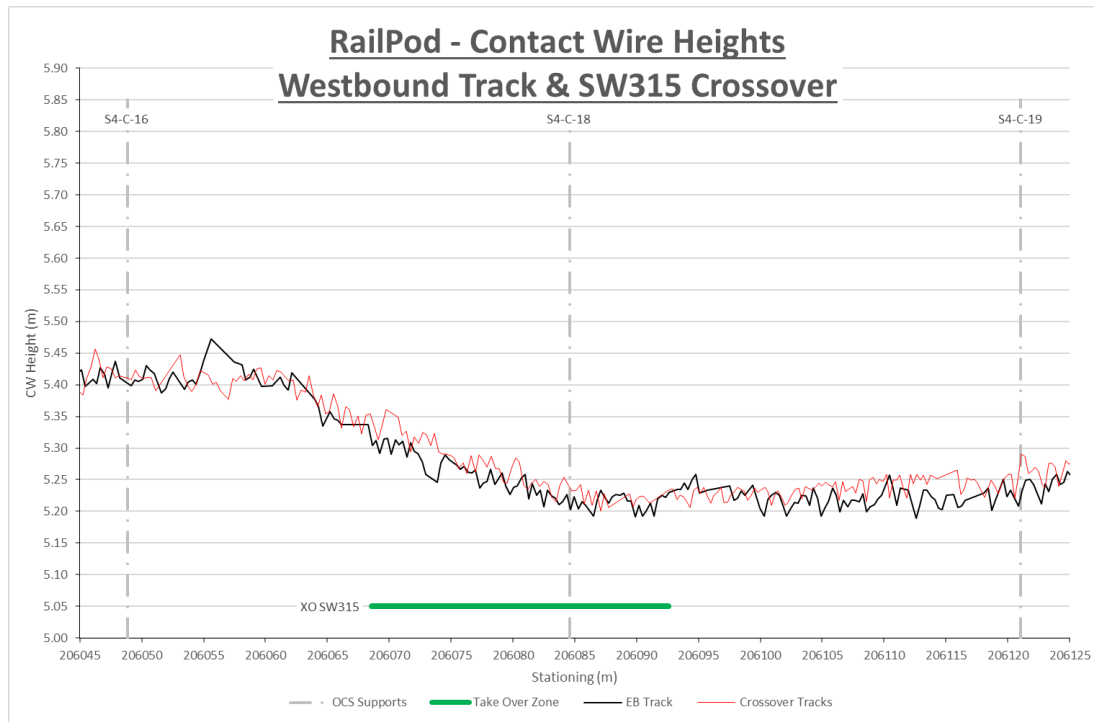
A typical example of where this is occurring is at crossover SW313 on the eastbound track. On the video, reference Gx060037-6 – at 16 seconds in, a sound can be heard as the pantograph hits the crossover wire. From the RailPod survey the observation can be confirmed as the crossover wire, within the take-over zone is lower than that of the main as shown in Figure 3.36.

**TableFigure 3.36: RailPod Data Analysis of SW313 Crossover Wire Heights**



Similarly where the take-over is satisfactory, SW315 crossover on the westbound track, as observed in the video, reference Gx060037-6 at 52 seconds in, and the RailPod data as shown in **Figure 3.37**.

**Figure 3.37: RailPod Data Analysis of SW315 Crossover Wire Heights**



### 3.2.1.8 Jumper Wires

The continuity of the messenger wire and contact wire are critical to supply the required current to the light rail vehicles without overloading any one individual wire **Figure 3.38**. To reduce the likelihood of a failure, the existing installation should be checked as soon as reasonably practical, and additional jumpers installed as necessary.

**Figure 3.38: Messenger Wire to OCR Jumper Wire**

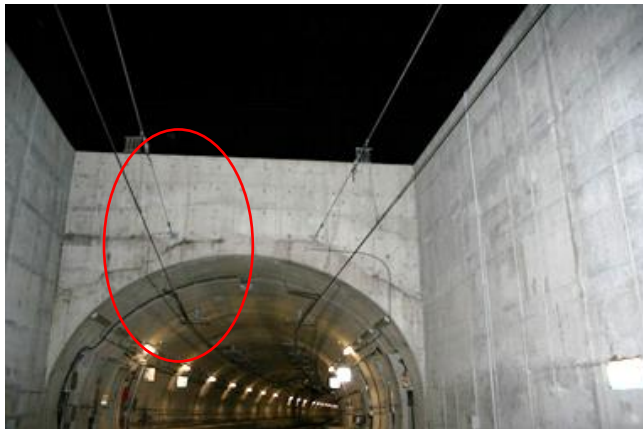


Photo source: Mott MacDonald

In accordance with Good Industry Practice for design and construction, Mott MacDonald recommended that messenger wires be bonded to the aluminium OCR at all OCS to OCR transitions, at both downtown tunnel portals and on both side of St-Laurent station over both tracks. The bonds installed should provide, as a minimum, equal ampacity to the messenger wire, reference Calgary LRT, Conductor Rail Installation Design Manual.

This report has been developed under a privileged and confidential assignment on behalf of the City of Ottawa. While the report has been prepared for release to City Council as requested by the City and counsel to the City, neither the City nor its' counsel waive privilege over the overall assignment.

**Figure 3.39: Messenger Wire Cut-in Insulation**

Photo source: Mott MacDonald

Mott MacDonald recommended that the messenger wires be bonded on both tracks, to provide continuity, with as a minimum, a wire of equal ampacity to the messenger wire.

**Figure 3.40: OCS to OCS at Crossovers and Turnouts**

Photo source: Mott MacDonald

In accordance with Good Industry Practice for design and construction, Mott MacDonald recommended that a second full-section or a MW to MW jumper is installed to provide equivalent ampacity of the sections of OCS **Figure 3.41**, reference Calgary LRT, Phoenix LRT, Santa Clara LRT.

### 3.2.1.9 Section Insulators

Section insulators are set up to provide a smooth transition from one OCS electrical section to another to minimize any potential damage to the section insulator and pantograph.

There is currently a speed restriction on a SI, at Location: SWT 327 to End of Track BLA Track 1, of 40 km/hr due to excessive arcing, as taken from the Summary of Current ML TSRs, July 08/2020.

Observations from the pantograph videos show the pantograph striking some section insulators, which is corroborated by the quantity of pantograph carbon strip chipping and cracking observed at the MSF **Figure 3.41**. At the ends of the SI, the contact wire and runners should be set at the same height with consistent wear on all three elements, to provide a smooth transition from the contact wire to the runners or vice versa. This with the fact that the bottom surface of

the section insulators shows uneven wear and arc splatter, suggests the section insulators are improperly set.

**Figure 3.41: Underside of Section Insulator**

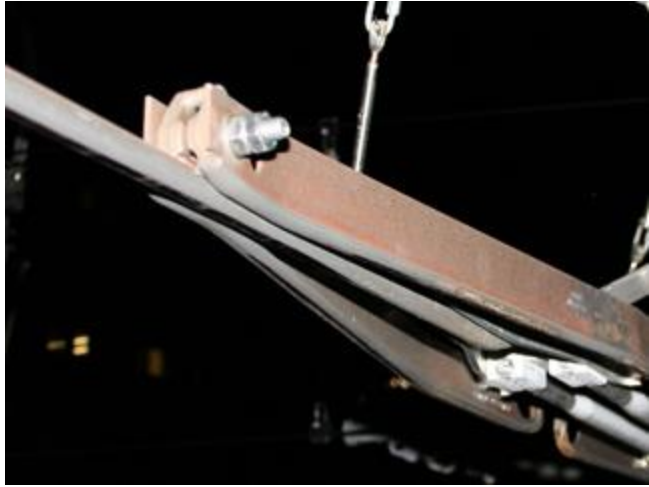


Photo source: Mott MacDonald

In severe failure cases, pantograph dewirement, damage to OCS conductors, or supports could occur, resulting in an outage of the service. Whilst it is not possible to eliminate the risk of a failure, due to other factors such as the pantograph, track and vehicle, to reduce the likelihood of a failure of the section insulator and reduced damage to equipment, the section insulators should be checked and adjusted as necessary using a dummy pantograph fitted to the maintenance vehicle.

Mott MacDonald recommends that all section insulators installation be checked as soon as is reasonably practical, and maintained in accordance with manufacturers instructions and Good Industry Practice.

### 3.2.1.10 Video Recordings of the Pantograph/OCS Interface

Two sets of video recordings have been provided showing the LRV pantograph as it traverses the OCS. The review of the two sets of videos, detailed below, indicate that many of the same issues still remain on the System and have yet to be addressed.

#### Videos from Wheel Rail Videos 2018.zip file

The OCS videos included in the file are understood to have been recorded on June 13, 2020, from the media information. The videos provided cover the east and west bound lines between Tunny's Pasture station and Blair station. No details are available as to if any of the issues identified in the video or as covered broadly in the media in late 2019 and early 2020 had been corrected prior to the full implementation of the Project Co Rectification Plan in 2020. Details of each video and a full list of observations are included in Table D.1 and Table D.2 respectively, with the more salient observations being:

- Poor running and set up of section insulators
- Out-of-running wire being struck by the pantograph horns
- Many instances where there are unusual clicking noises as the pantograph passes
- Single jumper wire at some overlaps and crossovers
- Stagers and mid-span offsets > 300mm

This report has been developed under a privileged and confidential assignment on behalf of the City of Ottawa. While the report has been prepared for release to City Council as requested by the City and counsel to the City, neither the City nor its' counsel waive privilege over the overall assignment.



- Feeder wires are only connected to the messenger wire
- Constant staggers for OCR
- In-span jumpers installed wrong way for direction of travel
- Catenary wire is not over the contact wire or, alternatively, over the centre of the track on tangent sections
- Jumper wires appear either too tight or too slack
- There does not appear to be a connection between the messenger wire and OCR at the transitions
- OCR not at constant height
- OCR arcing in many locations
- Zero contact wire staggers, especially in platforms
- Cut-in insulation in the messenger wire

### Videos from GoProVideos.zip file

The OCS videos included in the file were recorded in September 2020 after the implementation of the Project Co Rectification Plan in 2020. Note that only the main line OCS rectification work had been completed at the time of the video recording. The videos provided only cover LRV movements within the MSF and the westbound line between the MSF and Tunny's Pasture station and a small section either side of Rideau station. The position of the camera was further from the pantograph and subsequently more difficult to hear any potential issues highlighted by clicking noises. Details of each video and a full list of observations are included in Table D.3 and Table D.4 respectively, with the more salient observations being:

- No hangers installed in anchor spans
- Full-section jumper wires to be reviewed where only one has been installed
- In-span jumpers should be uninsulated as per design
- In-span jumpers installed facing wrong direction
- Staggers and mid-span offsets > 300mm
- Very little stagger change on OCR sections

#### 3.2.1.11 Balance Weight Anchors

Measurements of a sample balance weight at chainage 105+589, East of Hurdman, found in the incident logs was carried out, and the field data analysed.

### Design

The design of the balance weight arrangement at 105+589 consists of separate pulley and (steel) weight tensioning systems for the messenger and contact wires as shown on drawing MVA-54-0-S017-DRS-5119\_0.1, included as **Appendix Figure E.1**.

The balance weight guide tubes are shown to be connected to the upper and lower stops via internal pipe connections.

From the table on the drawing, for chainage 105+569, structure location S3-C-50 with a pole height of 7.2m, the tension length is 764m with maximum movement of the weight stacks being 4.60m.

An additional table is provided giving the height from ground to the underside of the weights.



## Maintenance Inspection

The maintenance of the balance weight arrangement, at 105+589, is described in document OTT-OCS-MTN10-WMS-002 - OCS Tensioning devices and Fixed Terminal Inspections, Rev A and the relevant extracts included as **Appendix Figure E.2** and **E.3**.

A limited number of items are included in the inspection procedure:

- 1 a. "Inspect Balance Weight assembly if you see or find some damages on each component," which is incomplete.
- 1 b. "Verify bolting, replace or tighten if necessary."
- 2 a. "Measure "h" Height from ground to counterweights(mm)."
- 2 b. "Compare the values with temperature table."

It is also noted that there are no tolerances quoted within the document to determine if any of the balance weight components need to be adjusted.

Details of the inspection and checklist carried by ALLTRADE/CYMI during the first year of service are included in **Appendix Figure E.4** and **Figure E.5** respectively.

Note that the Chainage is quoted as 104+589 and should read 105+589.

The visual inspection of the balance weight arrangement only identified some rusting of the U-bolts for the tension wheel and stop brackets.

The position of messenger wire (2250mm) and contact wire (2110mm) were measured from the bottom of the weights to the top of the hot stop bracket with the temperature noted as 17°C at the time of the readings.

No comments were made as to if any of the fixings were loose, so it is not possible to determine if there had been any potential issues with fixings working loose.

## Field Measurements/Inspection

Field measurements were taken, and an analysis of the existing balance weight arrangement is shown in **Appendix Figure E.6**. Due to limitations in site access, it was not possible to carry out a full inspection or take all relevant measurements to enable a full analysis of the balance weight arrangement to be carried out.

The following differences between the design drawing, MVA-54-0-S017-DRS-5119\_0.1, were noted:

- The low and high stop support brackets, as seen in **Figure 3.42**, the low stop support angle is installed in a different orientation and the high stop support bracket angle appears to be a different size.
- The guide tube to support angle fixing clamps, as can be seen in **Figure 3.42** and **Figure 3.43**, are external type which is different to internal ones as shown on the design drawing.
- The yoke plate assembly and balance weight hangers.

No details are shown on the design drawing, MVA-54-0-S017-DRS-5119\_0.1, of the balance weight guide eyes, with two being installed on each weigh stack as shown in **Figure 3.44**.

**Figure 3.42: Upper Stop Support Bracket**



Photo source: Mott MacDonald

**Figure 3.43: Lower Stop Bracket**



Photo source: Mott MacDonald

**Figure 3.44: Balance Weight Guide Eyes**



Photo source: Mott MacDonald

**Conclusion**

The calculated balance weight heights and maintenance measurements from the underside of the weights to the upper stop are different, could potentially be due to different datum points between the various measurements. However, the field measurements confirm there is a differential the heights of the weight stacks, which is not as per the design drawing MVA-54-0-S017-DRS-5119\_0.1.

Where the equipment supplied and fitted, such as the stop brackets, guide tube fixing clamps, yoke plate assembly and hangers, are different to the design drawing, these will affect the distance required between the low and high temperature stops. Some will also interfere with the movement of guide eye of the weight stacks along the guide tube, at the extremes of travel,

This report has been developed under a privileged and confidential assignment on behalf of the City of Ottawa. While the report has been prepared for release to City Council as requested by the City and counsel to the City, neither the City nor its' counsel waive privilege over the overall assignment.

resulting in undue loads being applied to the stop brackets and reducing the available travel height. Consequently, the tension in the wires may be reduced, affecting the integrity of the OCS and/or deformation of the upper and lower stop support brackets.

A full survey of the balance weight assembly should be carried out and analysis carried out to determine if travel between the two stops is enough and the weight heights are set correctly.

It is not clear from the design drawing and site inspection, if two guide eyes were proposed and that the distance between them has been accounted for in the upper and lower stop bracket separation during installation.

The ALLTRADE/CYMI maintenance report is only included for the measurement of the weights from the high stop bracket, with no analysis provided to determine if the weights were in the correct position.

The maintenance inspection only included a visual inspection and measurements of the weights from ground. While the visual inspection of the assemblies are comprehensive, the measurements taken for the balance weights are insufficient to determine if the assembly is within the design settings. A survey of the balance weight anchor assemblies should be carried out to determine the as-built configuration, including measurements of:

- The weight stacks from a fixed datum, not ground level as this can change over time.
- The distance between the stop and pulley wheel. This is critical to the operation of the stop, to prevent the weights from crashing to the floor/high temperature stop, in the event of a wire failure.
- Check wires on and off the pulley drums, especially for rubbing the sides of the pullies.
- Check movement of the pullies.
- Ensure all defects are noted, including loose fixings.

It is reported, in the ALLTRADE/CYMI maintenance report that several U-bolts are rusty. If not already instigated, further inspections/investigation should be carried out to determine the extent of the corrosion and if they need to be replaced.

### 3.2.2 Traction Power

#### 3.2.2.1 Introduction / Summary of findings

The Independent Review of the Ottawa LRT Traction power supply system has been based on comparing the original project requirements against the Rectification Plan, Project Co traction power design, incident logs, and typical SCADA system logs isolated to the traction power system and associated traction power substations (with detailed references provided below).

Following a review of Project Co traction power system design, the Traction Power Supply system (including substations) has been designed largely in compliance with the requirements of the client specification, Project Agreement - Schedule 15-2 Part 4, with the following notable points/exceptions:

- Notable Point – PA Schedule 15-2 Part 4, made no selection of system voltage, leaving it to Project Co. Presumably by agreement with the City and the vehicle provider, Project Co selected 1500V DC as the operational normal voltage for the DC traction supply.
- Exception – The system of negative return has been specified as a diode-earthed style of negative return via Systemwide Distribution Final Design Review Report RES-56-0-0000-REP-0093 and modelled for load-flow as a diode earthed system, but it has been implemented via examination of the grounding and bonding plan and the shop drawings

This report has been developed under a privileged and confidential assignment on behalf of the City of Ottawa. While the report has been prepared for release to City Council as requested by the City and counsel to the City, neither the City nor its' counsel waive privilege over the overall assignment.

as free-floating negative return. (It is important to note that a free-floating negative typically offers benefit to the system design as it regards to reduction of rail/accessible voltages and better control of stray current corrosion effects.)

Following a review of the operational incident logs (between June 2019 and October 2020), summaries of maintenance work orders and SCADA logs, the Alstom facilities reports and further information provided by the City of Ottawa, the following consistent issues have been noted:

- Negative Grounding Devices in TPSS/High Rail Accessible voltages – A review of data from June 2019 to October 2020, as provided to Mott MacDonald, has demonstrated that negative grounding devices in all substations and in combination between autonomous closure or trip event appear routinely throughout all logs. The fact that these devices are sealing the traction negative to local earth in response to over-voltage indicates that the equipment is responding to accessible voltage events. However, the sheer volume of these events would suggest either the equipment is faulty by design (as indicated by the frequent operation at all sub-stations), or is set incorrectly, or there are systemic accessible voltage issues in response to timetable operation of the LRV.

It is important to note if these are equipment faults or settings issue with some effort these matters can be relatively easily resolved. If there are systemic rail/accessible voltage issues around the network, these matters would require more in-depth study to resolve. This would typically take the form of network wide rail voltage monitoring analyzed against LRV movements. Where the data analysis from this concludes that simple corrective actions on the existing assets cannot solve these issues, rail voltage lowering methods may need to be employed. These measures could include additional TPSS, traction negative along track reinforcing conductors and increasing track to track and rail to rail cross bonding frequency. (Such measure could be employed singly or in combination.)

Project Co should provide a detailed analysis of NGD closure events and an analysis of the root cause. This will help to confirm whether these issues relate to equipment faults or settings issues; or are related to system overvoltage conditions around the network. The significance of this cannot be underestimated as the high rail accessible voltages that Project Co seems to share our concern with may be a safety issue, may be causing frequent closure of the NGD and may be contributing to the stray current issues now being identified by some of the adjacent utilities.

- Excess Stray Current at Utility Sites – Adjacent utilities were experiencing high levels of stray current from the Project. This has been followed by provision of a report by Enbridge of high levels of stray current interference on their gas utility cathodic protect schemes in parts of the network.

It was noted by Enbridge Gas Utility in March 2021 that elevated levels of stray current were present on Gas Mains near Parliament stop but that this had returned to normal levels in May 2021. This seems to coincide with the period that NGD were sealed closed for rail volts testing. However, in June 2021 Enbridge Gas reported further elevated stray current levels on gas mains along Tremblay Road and St Laurent Blvd.

Please note that the frequent operation of NGD noted above, (and manual and maintained closure over the period April – May 2021 in response to the Parliament arcing event of 05-03-21), may have contributed to the March 2021 excess stray current report. However, this cannot be wholly attributed to the elevated stray current levels recorded in June 2021 along

Tremblay Rd. and St. Laurent Blvd. when the network NGD devices had seemingly been restored to autonomous operation.

In addition to this, Mott MacDonald in response to some of the water ingress issues highlighted in the tunnels and stations highlighted in the Remediation Action Plan had previously requested, but not received, stray current performance data for the network.

The City of Ottawa has, also provided evidence of a High priority NCR entry (#802) which suggests that stray current performance of the network to the Project Agreement has never been verified through the provision of baseline reports during entry into service and early network operation.

To reiterate, Mott MacDonald was concerned by Project Co's generalized response to the arcing event of March 5, 2021, (see below), to close up all NGD at TPSS around the network. Whilst this was an understandable safety response to the matter, this would have inevitably promoted significantly elevated levels of stray current due to direct bonding of the negative bar/rails to ground. The reporting of Enbridge on March 18, 2021 of elevated stray current level on their cathodic protection schemes seems to have borne this out.

- Arcing Event of March 5, 2021 at LRV-1117/Parliament Station – The City noted a significant arcing event that took place on March 5, 2021 at LRV-1117/Parliament Station while an operator was trying to close a loose panel on the LRV. There were no injuries to personnel when it occurred. Project Co has attributed the flashover event to a damaged cable, but this event has illustrated more generalized concerns over the levels of accessible voltage around then network that it holds.

Mott MacDonald shared these concerns noting the frequency of NGD operations that had been occurring daily over the life of the system. From an email chain provided in data submitted to Mott MacDonald it was clear that Project Co had held these more generalized concerns for some time and had a plan in place to investigate rail voltage across the network over the period May – June 2021. (No evidence has been provided to confirm that the investigation was suitably concluded.) In the interim period from March – June 2021 Mott MacDonald understand that Project Co elected to manually close up all NGD devices at TPSS in an attempt to ensure system safety. The key points regarding this issue are as follows:

- Why did the over-voltage protection, grounding and bonding assets not intervene to put the system in a safe condition in the presence of the high accessible rail voltage?
- Is a voltage limiting device installed at this station and all stations across the network? It is conventional practice to do so in a free-floating DC traction system as per EN50122-1. Project Co should confirm if they are and if so, why did this station VLD-O not close in response to the high rail/accessible volts.
- Why are noted generalized concerns over high rail voltage which the Project Co maintainer not been formulated into a unique item in the system Rectification Plan? We suggest this is added.
- As highlighted earlier, Mott MacDonald is concerned about Project Co's response to its generalized concerns over high rail voltage by closing all NGD manually at each TPSS. Mott MacDonald saw this as having a limited benefit to system safety and mostly at stations near to TPSS. The manual and maintained sealing of the NGD would definitely promote stray current propagation around the network and at adjacent utilities because this solution effectively grounds the rails along the entire network.

- AC and DC Feeder Trip Events – A review of the data from June 2019 to October 2020 has demonstrated that in the early part of this period between June 2019 and June 2020 these trip events were high in volume, in excess of that which is typical of a new build system.

In review of additional logs (June 2020 – October 2020) the frequency of tripping events seems to have diminished. It should be noted that the Alstom infrastructure report, discussed settings issues as part of its reporting. At the time of writing this report it is unclear what actions have been taken by Project Co to reduce the frequency of tripping events (although there is clear evidence of a reduction in events); also, how they have addressed the issues in the Alstom report regarding tripping events. Project Co should confirm the actions they have taken to reduce the frequency of tripping events.

- TPSS02, 06, 07 and 08 – Substation Building Thermal Heating Issues – During the period April 2020 to June 2020, several substations were consistently recording building over-temperature alarms. Most notably and in order of frequency TPSS08, TPSS07, TPSS06, and TPSS02. Given the available data, it is difficult to see whether this is excess heating of equipment or faulted or incorrectly set TPSS HVAC equipment. More recently, these issues seem to have disappeared from the event logs. The reasons for this are unclear, it may be due to cooler outdoor temperatures or may be due to rectifications implemented by Project Co.

Mott MacDonald has requested further information from Project Co as to what actions have been taken to eliminate these issues but have not been provided a detailed response.<sup>10</sup>

- TPSS06 High Priority Alarms for Ground Faults –The City has offered a view that they, as Operator are receiving a lot of high priority alarms from sub-station TPSS06. In review of the events log provided by the City on April 29, 2021 it seems that these faults relate wholly to DC switchgear frame leakage/ground faults and have been present since February 2020 with only minor remediation attempts carried out over the period. The event log highlights upwards of 20 events which would have tripped electrical sections and by response would have affected service. From the descriptions in the event logs Project Co has eliminated faults in the protection equipment as the likely cause through some limited equipment swaps and testing. This would therefore suggest there is likely a frame fault condition in the form of an insulation breach at the DC switchgear. This could be within the switchgear or could be in an issue with the insulation installed between ground and the DC switchgear frame.

Mott MacDonald recommends that under an isolation the DC switchboard is visually inspected and its frame to earth resistance is tested. Equally the noted presence of high levels of moisture requires further investigation.

It is important to note that further substantiation is required for the frequent operation of the NGD and high levels of stray current around the network. Further background information has been provided by the City regarding stray current performance. Regarding NGD operation events, whilst some information has been provided by Project Co it is only partial and most lacks any useful context.

Aside from the issues noted at TPSS, many of the issues exposed through this review and through reports from the City of Ottawa would seem to trace back to rail voltage and grounding

---

<sup>10</sup> In January 2021 and within a periodic data submission supplied by Project Co an installation certificate for replacement of an air conditioning unit in TPSS08 was provided. It remains unclear whether this replacement was in response to the thermal issues noted during the summer months of 2020)

This report has been developed under a privileged and confidential assignment on behalf of the City of Ottawa. While the report has been prepared for release to City Council as requested by the City and counsel to the City, neither the City nor its' counsel waive privilege over the overall assignment.



and bonding issues around the network. These issues may also link through to the stray current issues being recorded. There may also be some issues with system performance to design but without any useful verification data having been provided (despite being requested) this is simply an assertion from some of the current and historical issues noted as defects around the network. Mott MacDonald would continue to recommend that further review of these systems is carried out over and above investigation into the specific issues noted above. Mott MacDonald would propose that some monitoring works for rail accessible voltage is carried out around the network with NGD open alongside a review of VLD-F and VLD-O application strategy around the network. We would also recommend that a wider review of grounding and bonding application around the network is carried out.

Clearly some significant stray current issues also exist. Despite the unique excess stray current events noted by Enbridge gas in March 2021 and June 2021, a lack of any baseline testing or provision of any baseline testing reports means that there is no evidence that the network has ever performed within stray current standards performance limits. There is no clear understanding by Project Co of network stray current performance.

Mott MacDonald has discussed the earthing and bonding and stray current issues on the Project in more detail elsewhere in this report, and made recommendations for investigations, inspections and validation activities to help remediate some of the issues being found around the network.

### 3.2.2.2 Traction Power System Design Overview

The Project Agreement (Schedule 15-2, Part 4) required a Traction Power supply with the following core parameters:

- Compliant with ANSI, NEMA, CSA, IEEE, IEC Standards, and City of Ottawa Codes and By-Laws.
- For Normal Operation: The Traction Power supply system is in full operation with all feeder breakers in closed positions. All scheduled service is running in accordance with the headway and consist with all civil speeds applied.
- For Contingency: The Traction Power supply system shall maintain full performance service with any one TPSS rectification power completely out of operation and the DC breakers remain closed or the DC disconnect switches are closed thereby utilizing the substation as a DC tie station.
- The Traction Power Supply shall be at DC voltage. (Client specification does not set a requirement for the voltage level.)
- Each track of the guideway is double end fed between the TPSS with insulation provided at the TPSS to sectionalize the guideway.
- The Traction Power Supply is deliberately insulated from ground along its entire length.
- The power supply for the Maintenance and Storage Facility is deliberately separated from the main guideway power supply. (Yard and Shop to be isolated from each other.)
- Negative rail voltage rise shall be limited to 50V under normal operation and 70V under outage conditions. Rail to ground sensing devices shall be implemented to monitor the negative voltage to ground and “clamp” the rails to ground upon exceeding pre-set limits.
- TPSS are of an identical and modular type positioned close to the guideway and passenger stations.
- TPSS consist of AC cables and raceway systems, AC switchgear, transformer-rectifier unit, DC switchgear, positive and negative raceway systems, positive and negative cables,

negative drainage panel and cables, rail to ground monitoring equipment, prefabricated substation housing (or dedicated space in or adjacent to a station facility) and foundation, grounding system, protective device systems, communications interface systems, auxiliary power supply system, climate, control, UPS system, intrusion access control system, MV lightning arresters, high voltage protection, alarm, control, and monitoring health and safety equipment, and SCADA equipment.

- TPSS are based on 3MW TPRU (12 pulse rectifiers).
- Stray Current Monitoring system to be provided.

The design produced by Project Co consisted of eight main guideway substations (at approximately 2km spacing) and one for the yard/shop and was largely compliant with the core PA requirements described above. OLE sectioning principles are detailed within OLE Sectionalizing Diagram RES-54-0-0000-DRD-2000.

Note there is a contradiction in some of the source data in that Systemwide Distribution Final Design Report, RES-56-0-0000-REP-0093 Appendix 4, Clause 5.4 sets out a requirement for TPSS with diode earthing, Grounding and Bonding Report RES-56-0-0000-REP-02621\_0 and TPSS shop drawings would suggest this has been implemented as a free-floating negative with over-voltage protection devices. (NGDs). However, it should also be noted as per the Mitigation and Monitoring of Stray Current Interference Effects report REJ-56-0-0000-REP-0125, drainage panels for control of stray current for adjacent utilities are provided at the TPSS which may hold accessible voltages at a higher level due to the negative blocking effect of the diodes.

Implementation of a full floating negative would normally offer a system that would provide lower rail/accessible voltage magnitudes and lower levels of stray current than a diode earthed system. *(Please note the issues recorded in analysis of accessible voltage, performance of negative grounding devices and utilities stray current within section 3.2.2.1 of this report.)*

Project Co prepared a load-flow simulation, (included in Systemwide Final Distribution Design Report RES-56-0-0000-REP-0093) with a selected voltage of 1500V DC and utilizing 3MW TPRU. (In the simulation report, as no negative voltage levels are present in the outputs and no input data states a case for a free-floating negative, it seems apparent that the system was modelled as a diode-earthed system.) With a substation spacing of approximately 2km, Project Co demonstrated a design that was compliant with the core requirements for Normal and Contingency operation up to and including operational scenario 3.

In review of the design information to date, there seem to be no significant non-compliance issues with the substations design. Please note this is limited to a review of the TPSS04 and MSF sub-stations shop drawings as exemplar. The design of the TPSS across the network is generally consistent and typically only vary by their site layout within their urban setting. The MSF sub-station differs in that its OCS feeding arrangement differ from typical line of route feeding arrangements and the treatment traction negative is different for electrical safety purposes. It was therefore reasonable for the purposes of this independent review to analyze one line of route substation and the MSF substation as a representative cross section of the typical design. Based on the limited engineering analysis described above, there seem to be no obvious and significant non-compliance issues with the substations design.

### 3.2.2.3 Stray Current Management and Grounding and Bonding Principles

#### *Stray Current Management*

As per Project Agreement Part 1 Article 14 and Schedule 15-2 Part 4, there are clear requirements detailed that Project Co shall provide measures to mitigate and monitor stray



current regarding insulation of rail systems and protective measures at lineside infrastructure including LRT owned major structures and adjacent/interfacing utilities.

Additionally, the PA sets out that drainage panels shall be provided at TPSS as drainage mechanisms for adjacent utilities. To comment on this, whilst providing drainage panels are a useful tool to mitigate stray current for vulnerable receptors, they do have a negative blocking effect regarding rail voltage i.e., tend to stop the rail volts floating negative. This results in greater rail voltage magnitudes. As stray current conducted emissions are proportional to rail voltage magnitudes and as studies in the UK and Europe have proven that omitting any drainage connections provides maximum benefit to stray current performance. This said, drainage systems are widely used and do offer means to control stray current.

There is a cross reference to a further part of the Project Agreement which is Part 1 – Article 14 – Corrosion Control.

There was a clear obligation placed on Project Co to mitigate and monitor stray current.

The provisions for Stray Current mitigation are described in *Systemwide Power Distribution Final Design Review Report (RES-56-0-0000-REP-0093)*, *Grounding and Bonding Design Report (RES-56-0-0000-REP-02621\_0)*, and *Mitigation and Monitoring of DC Stray Current Interference Effects (REJ-56-0-0000-REP-0125)*. (All were reviewed in October 2020.)

The main document that describes mitigation by design, intent to mitigate during construction, intent to mitigate during testing and commissioning and intent to mitigate during system operational life is described by the report, *Mitigation and Monitoring of DC Stray Current Interference Effects (REJ-56-0-0000-REP-0125)*. Gull River Engineering inc. were appointed by Project Co to support the design case for mitigation of stray current. There is clear evidence of identification of vulnerable receptors (utilities and major structures) and records of interface meeting with said utilities. Design drawings are provided for cathodic protection schemes at water utilities and monitoring points for electrical utilities. There is also a clear intent set towards de-risking stray current through construction testing, entry into service testing and commissioning and during the operational life of the System.

In combination the documents describe a clear design intent to manage and mitigate stray current. In isolation of the testing results in entry into service and early network operation, the design in isolation does not raise a cause for concern.

That some of the adjacent utilities are experiencing elevated levels of stray current suggests that an urgent review of previously requested stray current test data prepared by design and build contractor during construction, testing and commissioning, entry into service and early life operation is required. We would also recommend a review into Project Co's decision to temporarily seal NGD devices at the TPSS as being a contributory factor to these reports.

During the initial review of the Rectification Plan significant water ingress was noted as being present in the tunnels and station infrastructure. This prompted Mott MacDonald to raise an RFI and to request provision of up-to-date stray current monitoring reports, our concerns being prompted by our experience of stray current impacts due to water ingress on other similar systems. We have not been provided this test data by response. (NCR #802 suggests this data has also not been provided by Project Co to evidence compliance to the Project Agreement.)

### *Grounding and Bonding Principles*

Project Co has set out clear principles for management of the traction power supply regarding grounding and bonding (including stray current) in the *Grounding and Bonding Design Report (RES-56-0-0000-REP-02621\_0)*.

Project Co's Grounding and Bonding Design Report establishes principles for treatment of the traction power supply, (ac and DC including levels of rail/accessible voltage), the rail systems and associated equipment, the overhead line equipment, adjacent civil structures and lineside steelwork, lineside equipment and enclosures.

Whilst the principles are firmly established, the report lacks some detail in key areas of how to deal with interfaces with other disciplines particularly when it comes to establishing clearance zones and risk assessments, i.e., allowing clearance and risk assessment processes to drive decisions regarding grounding and bonding protection mechanisms with regard to separation, segregation, insulation, and over-voltage protection.

It is also important to reiterate that the Grounding and Bonding sets out principles associated with a free-floating negative as the basis of design rather than a diode-earthed negative, as set out by Appendix 4 of the *Systemwide Power Distribution Final Design Review Report (RES-56-0-0000-REP-0093)*. However, as stated above, drainage panels featuring diodes have been installed at TPSS which dependent on configuration may have a negative blocking effect.

Review of Grounding and Bonding plans in isolation would seem to demonstrate that interfacing designs for civils structures, TPSS, OLE, LV power, Lineside metallic structures, were designed in a manner that takes account of the grounding and bonding report in regard to integration, as would be expected in a Project of this nature. Mott MacDonald cautions that it is difficult to identify from the design detail provided the implementation strategy for VLD-F and VLD-O around the network.

The report of an arcing event on 5-03-21 at LRV-1117/Parliament station calls into question the design of over-voltage protection, grounding and bonding principles at the location of the event. It is conventional practice to have a VLD-O type device installed at each station to protect from over-voltages between the tram body/rails and the station infrastructure/general public. We request that Project Co confirm the status of the device if installed. If not installed, Project Co should provide a rationale for this not being present in the protection strategy for the station. This is discussed in more detail in section below.

#### 3.2.2.4 Verification and Validation of Design upon EIS

At publication of this Mott MacDonald report, review of the verification and validation data for the traction power supply system upon system integration has been limited by a lack of data.

Mott MacDonald has received, via RFI process EIS data for the OLE AC switchgear sub-stations only. *(It should be noted that these are mostly installation check sheets, although there is some system performance data included.)*

Despite requests, no data has been received that verifies installation of the DC TPSS, traction loading, OCS/OLE minimum voltage under load, rail accessible voltage or stray current performance to design parameters.

In reviewing this information, we would expect to see data that verifies that the as-built traction power supply is performing within acceptable tolerance the design parameters. In particular, that that network performance is within tolerance of the predicted load flow simulation (regarding minimum OCS/OLE volts, substation loading, and rail/accessible voltages) and that all protection systems and settings calculations have been verified via secondary injection testing and/or short circuit testing. Additionally, by analysis of telemetry and data it appears that that stray current issues are being suitably contained around the network.

Due to lack of data, we are unable to verify that the system is performing within design parameters. Evidence suggested by our review and also recent reports of defects by the City regarding arcing events (high rail voltage) and high levels of stray current would suggest that the performance of the network regarding levels of rail accessible voltage to design and by extension grounding and bonding and stray current requires expedited further review by Project Co.

Mott MacDonald has requested stray current baseline testing data in response to water ingress issues within the tunnels and stations. Given the recent report by the City of Ottawa regarding stray current at adjacent utilities this data urgently required. (Noting the existence of NCR entry #802 regarding missing stray current baseline data for entry into service and early system operation.)

### 3.2.2.5 Issues in Operation

The four consistent issues that have been noted in our review of the incident logs, work order logs, and SCADA logs are described in the summary of initial findings, section 3.2.2.1. Primarily this relates to excess stray current reporting, the frequency of operation for NGD devices at sub-stations, the frequency of AC and DC tripping events, and TPSS ancillary building alarms.

#### *Rail / Accessible Voltage*

Of particular concern is the frequency of operation of NGD devices and how this relates to system performance for rail/accessible voltage limits.

Specifically regarding the arcing event at LRV-1117/Parliament Station of 05-03-21 we note the unique response to the issue being attributable to a defective grounding cable. We share the concerns noted regarding excess accessible voltage at the rails as potentially being a root cause in our noting of frequent NGD operation around the network in SCADA event logs. We were concerned about Project Co decision to close all NGD at TPSS in response to these generalized concerns. This was borne out by the reports of excess stray current on adjacent utilities following sealing of the NGD in late March 2021. Closing the rail negative like this has the effect of promoting stray current around the network as it deliberately grounds the negative busbar at each TSS and effectively the rails.

These matters have been discussed in detail above, with the following recommendations made:

1. Arcing event of April 5, 2021 at LRV-1117/Parliament Station – Project Co has claimed that the arcing event at Parliament Station is resolved and has put the NGD in all TPSS back to normal operation as of May 2021. Documentary evidence should be provided, given the potential impact on electrical safety, which verifies that not only has the unique issue presented at Parliament Station been resolved but that the wider system concerns have been mitigated. (For Parliament Stn. Rail voltage testing results should be provided. For the wider system concerns see (2) below.)
2. System Performance for Rail Accessible Voltage – Related to activity 1 and borne out of concerns related to excess rail accessible volts, it is recommended that a program of rail volts testing is carried out initially in three representative sections of the guideway. One should include the electrical section adjacent to Tremblay Road. This would need to be done with the NGD locked open and Mott MacDonald recognize that is problematic given the arcing event of April 5, 2021, and concerns regarding over-volts and protecting the public. The alternative would be to run a shadow service out of normal hours. Mott MacDonald would suggest this testing is necessary as it will provide insights into system performance for rail volts, reasons for frequent NGD

operation around the network, the arcing event at Parliament and rail voltage impact on stray current performance. (This recommendation can be neglected if Project Co can provide evidence that representative tests for rail volts resulting in a pass criteria against a peak LRV service were carried out at entry into service and that safe levels are still being maintained to date.)

3. TPSS Negative Grounding Devices – Should activity 2 indicate that there are no systemic rail volts issues Project Co should investigate the root causes behind frequent operation of NGD devices at TPSS across the network. Is this faulty or incorrectly set equipment? Project Co to advise following a suitable investigation where it is required.
4. Clearance and Insulation Coordination with adjacent Railway Systems – Project Co should provide a specific review and assessment identifying how the traction power system interfaces with other disciplines, particularly when it comes to establishing clearance zones and risk assessments, i.e., allowing clearance and risk assessment processes to drive decisions regarding grounding and bonding protection mechanisms about separation, segregation, insulation, and over-voltage protection. While the intention to provide over-voltage protection in alignment with the requirements of EN50122-1 is clear within the Grounding and Bonding Principles report, it was not clear from detail design data provided in the IER where OVPD/VLD were required and have been installed. Could Project Co provide a list of installed OVPD/VLD devices around the network? Could Project Co provide a clearance and risk assessment report where significant interfaces are identified and where structures and adjacent cabinets/lineside steels/ station infrastructure and whether low voltage powered systems are positively included or positively excluded from over-voltage protection schemes?

#### *Network Stray Current Performance*

After reviewing excess stray current reports from Enbridge Gas, Mott MacDonald suggest that Project Co need to put in place a plan to remediate the noted stray current issues. As per such, we recommend that this focuses on the following:

1. Acknowledging Stray Current Issues in the network Remediation Action Plan, titled “Networkwide Stray Current Performance Mitigation.”
2. Addressing the concerns of the Enbridge Gas Pipe Corrosion Engineer raised in report of March 18, 2021 (gas utilities near Parliament stop) and in June 2021 along Tremblay Rd and St. Laurent Blvd.
3. A wider review of stray current testing and commissioning data, where available, for indicators of poor stray current performance around the network. (Provision of this data will allow for network performance review and will attend to NCR #802.)
4. Further investigation of the frequent NGD operations at TPSS as to whether this is a contributory factor to stray current performance. (Noting that during April-May 2021 report they were all believed to be closed in response to an arcing event at Parliament stop.)
5. Analysis of TPSS telemetry (for negative voltage) and along track negative voltage as an indicator of system defects e.g., inadvertent direct bonding to rail, inspection and possibly monitoring of the status of non-monitored VLD-F and VLD-O around the network. (We believe there are very few of these, but if they are dual duty VLD-F and VLD-O types then they may be frequently operating as per the NGD and contributing to poor stray current performance.)

6. Conduct focussed bonding inspections where analysis of TPSS and along track negative voltages as per (4) above indicates some inadvertent direct bonding to rail has been installed.
7. Following successful remediation, carry out a stray current baseline to reset the position on stray current monitoring and network performance.

Note: Development of the Rectification Plan should be coordinated via the stray current working group/party.

#### *Substations and Ad-Hoc Events*

As evidenced by our review of the incident logs aligned to early operation of the system, a wide range of tripping events and a high frequency of tripping events have been present in all parts of the network. During 2020, there is clear evidence that the range of events relating to the traction power supply system had diminished but not been eliminated. Additionally, the frequency of events has diminished specifically in the area of feeder breaker trip events. This said, the City noted the re-emergence of frequent high priority events at TPSS06 relating to ground faults. Reviewing the data provided by the City in this regard there are question marks over the effectiveness of the insulation at the TPSS06 DC switchboard that should be inspected, tested under an insulation resistance test and remediated where required. The presence of high levels of moisture in the building, and similarly reported for TPSS08 via the event logging for TPSS06 requires further investigation.

In addition to these issues, there are more isolated events that have occurred in system operation related to the traction power supply. However, these issues can largely be described as one-off events that tend to occur occasionally in a light rail system. These range from equipment over temperature issues to minor vandalism events, and are expected to occur during operation of a System, and be addressed in accordance with their respective priority within an operations and maintenance framework.

#### 3.2.2.6 References Used in Traction Power Review

Full listing of references used to analyze the Traction Power system for the Project are available in Volume 7.

### 3.2.3 GIDS and SCADA

Supervisory control and data acquisition system is a control system architecture comprising computers, networked data communications and graphical user interfaces and human machine interfaces for high-level SCADA system supervisory management.

The GIDS interface with the SCADA system is used to support public and operational safety of the System, with focused deployment at guideway access points such as platform ends and edges, tunnel portals, level crossings, and facilities such as TPSS.

#### 3.2.3.1 Introduction and Key Operational Issues

Mott MacDonald reviewed the GIDS and SCADA system by comparing the original project requirements against the Rectification Plan, incident logs, and typical SCADA system logs (with detailed references provided below).

The key operational issues (from the Rectification Plan, SCADA system logs, and discussions with the City of Ottawa, as the Operator) understood by Mott MacDonald included:

- Events generated from the GIDS causing an operational disruption to the light railway, due to interfacing signals between the GIDS and the CBTC system.

This report has been developed under a privileged and confidential assignment on behalf of the City of Ottawa. While the report has been prepared for release to City Council as requested by the City and counsel to the City, neither the City nor its' counsel waive privilege over the overall assignment.

- Events on the SCADA system causing an operational disruption to the light railway, due to the high volume\* and categorisation of alarms, e.g., alarm handling and management.

(\* Circa 3,000+ on the typical sampled day, see commentary in the following sections.)

Mott MacDonald understands that reducing operational disruption will have involved:

- Reducing the volume of GIDS and SCADA system alarms, including investigating the root cause of the alarms (including interfacing systems to the SCADA system).
- Reducing the volume of errors on the GIDS and SCADA system, including system faults (as noted in the typical failure points work orders).
- Reviewing the organization of alarms, including management and handling by the Users / Operators via the GUI / HMI.
- Recognizing which interfacing system (e.g., plant) are the root cause of alarms and separately investigating failures in the interfacing systems.

Mott MacDonald has sought evidence from Project Co that reductions in operational disruption have occurred, including the addressing of the above noted points.

### 3.2.3.2 Summary of Progress

A review of operational issues associated with both the GIDS and SCADA system was completed by Mott MacDonald and is summarized in this section.

Initial informal questions and requests for information were raised and discussed with the City in November 2020. A further review of the GIDS and SCADA system was completed based on the available information provided since November 2020 and has been incorporated into this report.

### 3.2.3.3 Requirements vs Operation – GIDS

For the GIDS, from the output specification (section 5.10, part c) there is a requirement on train control for system safety:

“The CBTC System shall respond to intrusion detection by alarming drivers and enforcing stop and proceed orders, speed restrictions or stop and hold orders as warranted by the Safety Analysis.”

Upon review (based on the Rectification Plan and typical SCADA system logs) the GIDS appeared to be detecting intrusions and passing these alarms to both the SCADA system and to the CBTC system. On this basis, the operation of the GIDS and CTBC system interface appeared to meet the output requirements.

Further to this, the Rectification Plan indicated that the GIDS was detecting “false positives.” On this basis, it appeared the operational issue resided within the GIDS and not the GIDS to CBTC system interface. The GIDS, therefore, has been reviewed further, as described in the following sections.

### 3.2.3.4 Requirements vs Operations – SCADA

For the SCADA system, the PA Schedule 15-2 Output Specification Part 4, Article 6 (throughout multiple sections, including section 6.2, item i) contains detailed system requirements. Section 6.3, item h, item xii also makes specific reference to “alarm management” and “user defined reports.” On this basis, it appears that alarm management is a requirement of the SCADA system and, therefore, has been reviewed further, as described in the following sections.



### 3.2.3.5 Overview of the Installed Systems – GIDS

According to the intrusion system design (ref. RES-53-0-0000-REP-0159, section 3.1.1.6) the tunnel portal intrusion detection sub-system (presumed to be the GIDS) is a laser-based system that watches portals and is:

- Monitored by the CBTC system
- Monitored by the SCADA system
- Observed by the closed-circuit television (CCTV) system

Also, according to the station communications design drawings, GIDS sensors are located in stations above the track at the end of the platforms, with associated CCTV cameras oriented towards the GIDS sensors.

### 3.2.3.6 Overview of the Installed Systems – SCADA

According to the SCADA design (ref. RES-53-0-0000-REP-0222) and station communications design drawings, remote terminal units interface via marshalling panels to various sub-system fields assets. The SCADA RTUs then communicate over the central transmission system (communications network) to the master-station (head-end) in the transit system control centre that includes GUI / HMI and alarm management (SCADA design section 4.1.1).

### 3.2.3.7 Response to Operational Issues – GIDS

As stated in the Rectification Plan, Mott MacDonald understands that GIDS firmware and software upgrades are occurring as well as some on-site operational and maintenance changes (as described in detail in the response). According to the Rectification Plan, the number of “false positives” should be reduced by the firmware upgrades and software applied to the GIDS.

The City has advised, and from review of GIDS activation data (Sep-20 to May-21), it is understood that reductions in “false positives” from the GIDS are occurring (with positive results); however, the GIDS is still indicating alarms for slow moving LRVs, weather and “unknown” reasons. There have also been two incidents of the GIDS detecting a trespasser.

From further discussions with the City and review of GIDS activation data (Sep-20 to May-21), it is understood that the on-site operational and maintenance changes to the GIDS (as noted above, that included configuration changes) have reduced (but not removed) operational disruption caused by “false positives.”

### 3.2.3.8 Response to Operational Issues – SCADA

The typical SCADA system logs show that there is a high volume of alarms (circa 3,000+ on the typical sampled day). The City has advised that this number has been reduced from circa 10,000 alarms; however, with the present high volume of alarms, further review has been undertaken, as described in the following sections.

From the typical SCADA system logs, alarms for a typical day (the typical sampled day) can be categorized into the following broad categories:

- Approximately 34% relate to doors
- Approximately 30% relate to station plant
- Approximately 26% relate to traction power\*

\* Note – a majority of these traction power alarms are as a result of NGDs.



These broad categories account for 90% of the typical daily alarms. This would suggest the following possibilities for root cause:

- There are genuine failures of the connected systems (doors, station plant, traction power)
- The plant is not configured correctly and is giving false alarms
- The SCADA system is collecting indications as alarms that are not relevant to Users/Operators
- The SCADA system is not configured properly and is recording events as false alarms
- Other possible root causes, requiring further investigation

Refer to the SCADA summary and recommendations for further comments on root cause investigation.

### 3.2.3.9 Review Approach

Based on the output requirements vs operation (see section 3.2.3.3), the operational system (as described in section 3.2.3.5) and the responses to operational issues (section 3.2.3.7), both the GIDS and SCADA system review has consider the following:

- Further requirements – beyond those in the output specifications
- Systems design – to meet requirements
- Installation, configuration and testing – to prove the design
- Operations and maintenance – to meet the requirements.

This approach follows the Verification and Validation model (the “V-model” process), whereby project outcomes can be validated against original project requirements by tracing the steps noted above. The Verification and Validation model represents Good Industry Practice in design and is based on the association of a testing phase for each corresponding development stage.

### 3.2.3.10 Further Requirements – GIDS

There is no evidence of any further specific GIDS or SCADA system requirements captured by the Project through engagement with the City (including Operations), further to those in the output specification.

### 3.2.3.11 Further Requirements – SCADA

Some of the further SCADA system requirements include the following (representing Good Industry Practice):

- A requirement for an alarm strategy.
- Requirement for alarm management and handling.
- Identification and consultation during the SCADA design process with Users / Operators (users may include Operations, Maintenance, Security, Station functions, etc.).

The City has advised that as of November 2020 there is no evidence of the following (representing Good Industry Practice in design):

- Provision of an alarm strategy.
- That the Users/Operators were consulted when considering pre-design requirements for an alarm strategy or alarm management and handling.
- Consideration or engagement within the Project of which alarms would be required according to a given function, e.g., Operations, Maintenance, Security, Stations.

- Assignment or agreement of responsibility and ownership of alarm management and handling.

Notes:

- No further evidence of the above noted items has been received since November 2020.
- Refer to the SCADA summary and recommendations for further comments on the alarm strategy and engagement with Users/Operators.

### 3.2.3.12 Systems Design – GIDS

According to the SCADA system design (ref. RES-53-0-0000-REP-0222) the GIDS design is described in document MAI-50-0-9026-DRS-GIDS. A copy of the GIDS design document was requested through a request for information (RFI, reference to be confirmed) however not received.

A copy of the GIDS Final Design Review (ref. OLR-50-0-0000-REP-0003) was provided and does include a requirement for a configurable object size, including differentiation of a person.

There is no evidence of the following (representing Good Industry Practice in design):

- Object speed requirements were ever defined.
- An operational window was ever defined.

Refer to the GIDS summary and recommendations for further comments on the GIDS operational definitions.

### 3.2.3.13 Systems Design – SCADA

The SCADA system design (ref. RES-53-0-0000-REP-0222) has been reviewed at high level to understand the sub-systems input / output list at out-stations and the GUI / HMI at master-station (including consideration of human factors for alarm handling). The SCADA system design includes:

- A requirement for alarm handling (section 2.2.7 of the concept design and sections 2.0 and 2.1 of the SCADA design)
- A requirement for a configurable GUI / HMI (sections 2.1 and 3.2 of the SCADA design)
- A user configurable GUI / HMI (sections 3.2 and 4.1.1 of the SCADA design)
- I/O lists for each of the stations

Despite repeated requests to Project Co, no evidence is available of the following items (representing Good Industry Practice):

- That the Users / Operators were consulted during the I/O list selection, or for the selection of categorization, prioritization, etc.
- That an assessment was undertaken by the Project to determine how many alarms may be generated based on the number of I/O

It appears that the Project decided on an I/O list and that a configurable User/Operator workstation has been provided whereby all I/O status changes, indications, alarms, etc., are presented for the User/Operator.

It appears that the Project required a Human Factors assessment (under the Systems Engineering Management Plan, ref OLR-50-0-0000-MPL-0005) however there is no evidence of the following items (representing Good Industry Practice in design):

- That the Human Factors or Ergonomics assessment was undertaken.
- That the assessment considered how many alarms and indications the User/Operator may be able to handle.
- That the assessment considered how many User/Operator workstations are required, based on the volume of alarms and indications.

It is concluded that a Human Factors Study was not undertaken by Project Co as part of the design process.

#### 3.2.3.14 Installation, Configuration and Testing – GIDS

It is noted that the GIDS system is operational, but there were no records provided of any GIDS configuration and testing, beyond those requirements provide in the GIDS Final Design Review (ref. OLR-50-0-0000-REP-0003).

There is no evidence available demonstrating that the installed and configured GIDS is able to fulfill any requirements for object detection and differentiation.

#### 3.2.3.15 Installation, Configuration and Testing – SCADA

Project Co's System Integration Testing document (ref RES-16-4-MEAB-SIT-5R2038) indicated that the SCADA system HMI was "configured properly." However, there are no further details of the following items (representing Good Industry Practice in design):

- Configuration or functionality details
- Testing details, including pass / fail criteria
- Alarm management and handling details.

The completion logs (reference OLR-16-0-0000-MAN-0002) and SCADA as-built documentation do include details of:

- SCADA system network commissioning
- SCADA system interfaces including GIDS, fire alarm systems
- SCADA system factory acceptance testing ("FAT")
- SCADA system site acceptance test ("SAT") in stations
- SCADA system SAT in traction substation substations
- (Various other SCADA system related testing)

#### 3.2.3.16 Operations and Maintenance – GIDS

The September 2020 reliability report (the most recent reliability report with references to GIDS) has indicated that the GIDS firmware and software was updated in May 2020 and was still under monitoring.

No evidence of O&M manuals, training or handover to Operators for GIDS have been provided.

#### 3.2.3.17 Operations and Maintenance – SCADA

SCADA system handover documentation has been provided that includes:

- SCADA system O&M manuals, including configuration guides, user guides, installation guides
- Training material for administration, configuration, installation, users
- GUI / HMI and alarm pages

- Technical description of SCADA system operation
- SCADA system I/O lists

The City has advised that in November 2020 and April 2021:

- Basic training has been provided by the Project to the City (as the Operator).
- Alarm management and handling resides with the City (as the Operator).
- The City (as the Operator) then decides what alarms are then passed to Project Co (as the Maintainer), of which approximately 90%-95% are then passed from the Operator to the Maintainer.
- Project Co (as the Maintainer) does not use the SCADA system however does have access to the system. No details of operational procedures or responsibilities (either for the Operator or Maintainer) have been provided.
- Project Co (as the Maintainer) are responsible for security at the Maintenance and Stabling Facility.

### 3.2.3.18 Summary and Recommendations – GIDS

The GIDS is in operation and does meet technical aspects of the project requirements (e.g., there is a system present and it is operating), noting that there are still instances of “false positives” and therefore requires further remedy.

The following items are recommended, representing Good Industry Practice in design:

1. Further definition of requirements – including object speed and operational window
2. Providing details of installation, configuration and testing – including test pass / fail criteria, test cases and evidence of compliance with the design
3. Review of the current installation and configuration against the further defined requirements so that the instances of “false positives” and detection failures can be further reduced.

### 3.2.3.19 Summary and Recommendations – SCADA

The SCADA system is in operation and does meet technical aspects of the project requirement (e.g., there is a system present and it is operating), however the SCADA system in its current configuration is providing a large volume of alarms (3,000+ for a typical sampled day) that is causing operational disruption and therefore requires further remedy. Further to this, concerns have been raised by the Operator (the City) that the large volume of alarms may cause a distraction or complacency from safety related matters.

The following items are recommended (by a party or parties and in timescales to be agreed with the City), representing Good Industry Practice in design (as also described above):

1. Development alarm strategy that includes differentiation of events, indications, alarms
2. Development requirements alarm management and handling
3. Consultation with Users/Operators for the development of the alarm strategy, alarm management and handling requirements
4. Agreement with Users/Operators who will be responsible for review events, indications (e.g., Operators) and who will be responsible for actioning alarms (e.g., Maintainers). Develop or redefine documented operational procedures and responsibilities for both the Operator and Maintainer based on this agreement.
5. Root cause investigation of the highest three broad categories of alarms, including a review of the interfacing systems faults and configurations.

6. Engagement with Human Factors and Ergonomics to assess the volume of alarms, the type of alarms, the number of User/Operator workstations.

### 3.2.4 CBTC

Communications-based train control is a railway signaling system that makes use of wireless telecommunications between the train and track equipment for the traffic management and infrastructure control. By means of the CBTC system, the exact position of a train is known more accurately than with the traditional signaling systems. This results in a more efficient and safe way to manage the railway traffic, and railway systems are able to improve headways while maintaining safety.

#### 3.2.4.1 Introduction and Key Operational Issues

Mott MacDonald reviewed the performance of the CBTC System in light of the Rectification Plan, reliability reports, incident logs and system User Guides (with detailed references below).

The key operational issues (from the Rectification Plan, incident logs and discussions with primary concern disciplines) are understood by Mott MacDonald to include:

- Excessive numbers of Emergency Brake application resulting in minor delays to individual vehicles as well as in increased wear and tear on vehicles (including “wheel flats”).
- Lower than expected reliability of vehicle on-board controllers which require the Operator to operate with coupled vehicles to ensure redundancy in the system, even in times of low passenger numbers. Failure of a VOBC in a single, non-coupled vehicle could lead to operational disruptions.
- Project Co has identified some generic issues with the CBTC system, which are not safety-related but impact operational performance.

During 2020, mitigation measures were being undertaken by updating the CBTC system software to address certain Emergency Brake application scenarios (as noted in the Rectification Plan).

The quarterly maintainability and reliability reports, provided by Alstom, indicate that in the period up to January 2021, there were only five Service Affecting Failures (SAF) of the CBTC system since the start of operation. The number of Non-Service Affecting Failures is stable, at less than 25 per month.

The Mean Time Between Failures (both SAF and NSAF) has improved over time and since August 2020 the MTBF is at a stable level of above 450 hours.

#### 3.2.4.2 Overview of the Installed Systems

According to the OLRT ATC System User Guide, the CBTC system applied in Ottawa LRT consists of various key components:

- Automatic Train Supervision system, primarily located at TSCC, used for monitoring and control of train movements.
- Central Service Regulation Subsystem server, which ensure the ATS can communicate with the Zone Controllers.
- Zone Controller, (which calculates the Movement Authority (“MA”); the area where the vehicle can move safely). There are several ZCs on the network.
- Vehicle On-Board Controller, which supervises the vehicle’s movement.

The CBTC system enables various operational modes:

- Unattended Train Operation: automatic operation of Vehicles without an operator onboard.
- Automatic Train Operation: automatic operation of Vehicles with a Driver supervising the train from the cab. The Driver initiates station departures.
- Automatic Train Protection, Manual: Manual operation of Vehicles by a Driver, under full supervision and protection by the CBTC system.
- Restricted Manual: Manual operation of Vehicles by a Driver, in degraded mode with maximum speed of 25 km/h. There is limited protection by the CBTC system.

#### 3.2.4.3 Response to Operational Issues

From the Rectification Plan, Mott MacDonald understands that CBTC firmware and software upgrades (up to version 7.0) has been prepared which should resolve frequently occurring issues. Multiple software updates were implemented across the System in 2020.

#### 3.2.4.4 Review approach

An initial review of the incident logs has indicated a decrease in frequency of occurrence of various issues from September 2019 onwards, indicating that various issues could be typical start-up problems associated with commissioning of the new system.

The detailed review approach focuses on verifying the ongoing applicability of the issues as stated in the Rectification Plan and commenting on the proposed resolution measures.

#### 3.2.4.5 Review Result

Mott MacDonald has analyzed the incident logs to verify the issues presented in the Rectification Plan. It is noted that the format of the incident logs has changed between three periods (September 2019 – May 2020 and May 2020 – December 2020 and December 2020 – onwards). Part of the changes between incident logs includes a different way of allocating events (“issues”) to systems. The systems list and allocation of issues in the incident logs after May 2020 is ambiguous, which makes it difficult to ensure all CBTC-related events are identified and analysed. On the other hand, non-CBTC-related events (e.g., broken cab window) are allocated to the CBTC system. Several events are allocated to the CBTC system but have no incident description.

Mott MacDonald have analyzed the incident logs to their best ability but cannot guarantee that 100 percent of the events have been captured. The quality and usability of the incident log of Sept 2019 – May 2020 exceeds the logs from May 2020 onwards.

### Emergency Braking events

The review of the incident logs acknowledges the frequent occurrence of Emergency Brake events. The following EB events have been observed several times:

- EB due to overspeed in ATO
- EB due to overspeed in ATPM
- EB due to unauthorized crawlback
- EB due to VOBC issues
- EB due to obstructed motion
- EB due to intrusion detection by GIDS

### Obstructed Motion

According to the ATC User Guide, an EB due to obstructed motion occurs when the propulsion command from the CBTC system does not result in sufficient train motion. To avoid damage to

This report has been developed under a privileged and confidential assignment on behalf of the City of Ottawa. While the report has been prepared for release to City Council as requested by the City and counsel to the City, neither the City nor its' counsel waive privilege over the overall assignment.

the train propulsion systems, the CBTC system activates the EB and removes the propulsion command. Several EB due to obstructed motion events are observed to be related to brake faults. In such cases, the CBTC system performance is as intended.

### **Intrusion Detection by GIDS**

EB events following GIDS-activation are not considered to be related to the performance of the CBTC system and discussed elsewhere in this report, Section 3.2.3.

### **Overspeed**

Application of the EB due to a train exceeding the speed limit (“overspeed”) is considered normal, intended behaviour of the CBTC system. Included in the overspeed events are movements outside the MA (speed limit = 0 km/h).

When operating in ATPM mode, overspeed can occur due to temporary distraction of an operator or application of insufficient braking power, leading to a train exceeding the limit of its MA. According to the Train Operator User Guide, the CBTC system will trigger a Full Service Brake when 1.44 km/h (0.4 m/s) over the authorized speed. When the overspeed exceeds 1.0 m/s, the EB is activated. EB in ATPM events have not been analyzed in detail.

EB due to overspeed in ATO is considered undesired behaviour of the CBTC system. Although the EB ensures the safety of train operations, the ATO algorithm should be tuned such that it does not exceed the MA. EB events due to overspeed in ATO have been observed frequently (average 20/month) in the first three months of operation (see **Figure 3.45**). From December 2019 onwards, a gradual decrease has been observed with only 0-3 events per month since March 2020. As such, the issue seems to have been resolved over time and could be considered start-up problems of the new system.

Furthermore, some of the events indicate that the EB due to overspeed in ATO event is linked with other problems (e.g., coupler issue) suggesting that the cause of the event is outside of CBTC system.

### **Unauthorized Crawlback**

According to the ATC User Guide, when a train overshoots a platform by a minor distance, the operator can crawlback (reverse) to meet the intended stopping position, typically after consultation of TSCC. A train operator performing a crawlback movement must ensure the reverse speed does not exceed 5km/h and the movement is not further than 5m. Crawlback movements outside these limits, or at unauthorized locations, will trigger the EB (Unauthorized Crawlback).

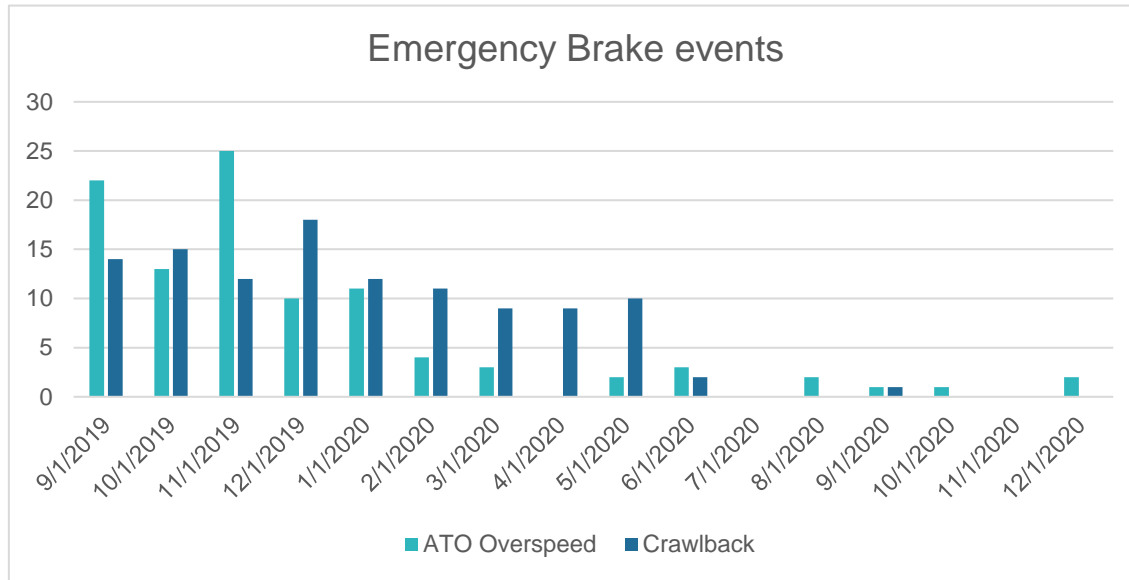
Analysis of EB events due to unauthorized crawlback reveals these events often do not mention initial overshooting of platforms. A significant number of the unauthorized crawlback events takes place at Blair and Tunneys stations. In a number of these events, it is noted that the “operator keyed in too quickly.” This indicates that several occurrences followed the turnback movement while changing from one driving cab to the other.

The system appears to be working as intended (preventing reverse movements beyond the crawlback limits), but the functionality might be installed in a suboptimal manner when dealing with turnback movements. We would expect the crawlback authorization to be revoked once a cab is deactivated and the vehicle is prepared for movement in the reverse direction. Proper training and correct following of procedures by Train Operators, especially with regards to turnback movements, could prevent occurrence of this issue.



As visible in **Figure 3.45**, from June 2020 onwards, the number of EB due to unauthorized crawlback events has decreased significantly which could be following the upgrade of the Thales CBTC software.

**Figure 3.45: Overview of Emergency Brake Events (Overspeed in ATO and Crawlback) Per Month**



Source: Mott MacDonald, based on incident logs provided by the City.

**VOBC Behaviour**

All vehicles are equipped with one VOBC, which is comprised of three replicas arranged in a redundant two-out-of-three configuration. When operated in a coupled configuration (2 LRVs), the second vehicle provides a second VOBC, which normally operates in a passive mode. Only a single VOBC can be active at a given time. When the active VOBC fails, the passive VOBC can be activated to resume operation. The ATC User Guide acknowledges that an EB during such a VOBC switchover is normal procedure. The incident logs reveal several occurrences of the EB being applied following a VOBC failure.

**ATPM – ATO Switchover**

According to the Rectification Plan [3] there are operators experiencing Emergency Brake applications when transitioning from ATPM mode into ATO mode while the vehicle is in motion. According to the Train Operator User Guide and ATC User Guide, drivers should be able to switch between ATO and ATPM modes while moving. Changing other modes (except ATO-ATPM) while moving will cause the VOBC to apply the Service Brake, and in some circumstances the Emergency Brake. The application of the Emergency Brake while changing between ATO and ATPM modes is unexpected behaviour. The incident logs list few EB application events specifically related to mode changeover, so the extent to which this issue is occurring is not clear. Project Co’s Task Force recommends to only switch from ATPM to ATO while stationary. Mott MacDonald considers this procedure a reasonable resolution to the issue.

**VOBC Reliability**

The reliability of VOBCs is understood to be below expectation with VOBC halts occurring more frequently than deemed acceptable. VOBC errors are considered to be two-fold: 1) VOBCs in active mode failing, requiring changeover to the passive VOBC and 2) communication losses between the VOBC and ZC. The operation of coupled trains partly resolves issues with

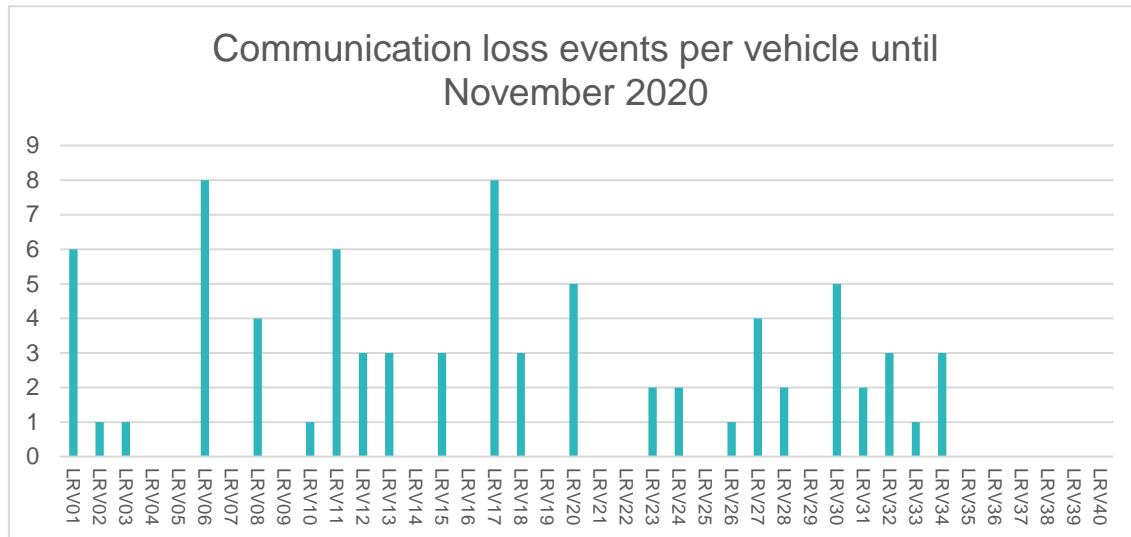
This report has been developed under a privileged and confidential assignment on behalf of the City of Ottawa. While the report has been prepared for release to City Council as requested by the City and counsel to the City, neither the City nor its’ counsel waive privilege over the overall assignment.

active/passive changeover, although potentially leading to an Emergency Brake application (see above). Thales has acknowledged the VOBC halts issues and this should be resolved via software updates. During 2020, multiple software updates were performed (up to version 7.0 in October 2020). A downward trend of the frequency of these errors occurring was observed following the updates.

The issue of communication losses has been analysed in the incident logs. **Figure 3.46** shows the number of times each vehicle was involved in a communication loss event. When operated in coupled mode, an event is allocated to both vehicles. It is visible that LRV06 and LRV17 have experienced most events, followed by LRV01 and LRV11. In 15 of the 39 events (38%), either LRV06 or LRV17 was involved. The figures are not adjusted for distance driven.

The analysis reveals that some vehicles experience a larger number of communication events than others, which indicates that this could be due to isolated vehicle issues. Additional technical and reliability analysis of vehicles experiencing an increased number of communication issues could indicate the actual cause of the issues.

**Figure 3.46: Communication Loss Events Per Vehicle. When Operated in Couple, an Event is Allocated to Both Vehicles**



Source: Mott MacDonald, based on incident logs provided by the City.

**General CBTC issues**

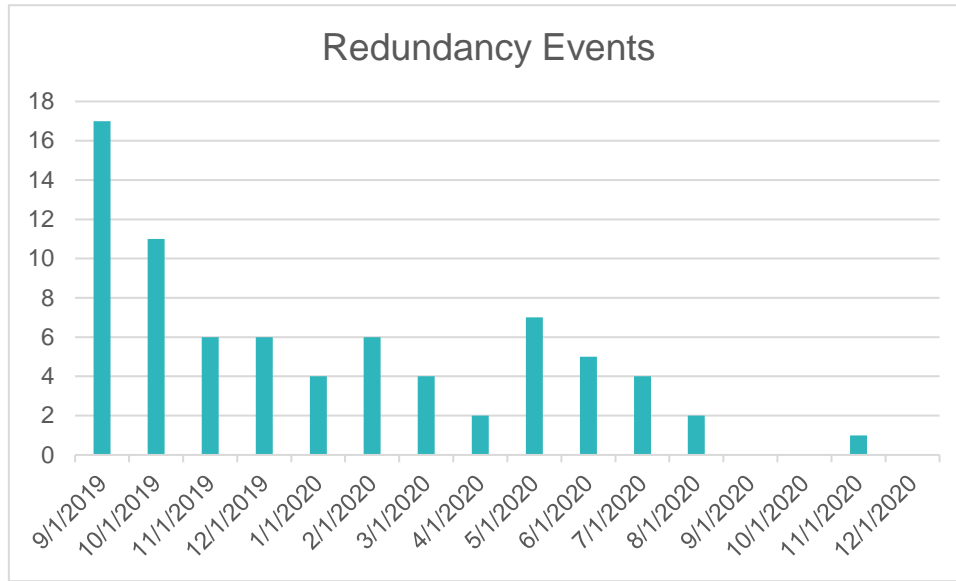
The Operator has identified general issues with the CBTC system through revenue operation. The Incident Logs reveal a number of system events related to redundancy issues, where certain systems (e.g., ZC, CSRS or LSRS) are operating in redundancy, i.e., the passive server taking over control due to failure of the main server. Most of these events involve the Local SRS, which are already a backup system to the Central SRS. While redundancy events do not directly result in service degradation, they could pose a risk for decreased service availability should these happen so frequent that maintenance staff cannot deal with the number of issues in a timely manner.

**Figure 3.47** shows that system events related to redundancy were most frequent during the first months of operation. From November 2019 through July 2020, the events occurred at a rather stable level. It is normal that switchovers occur occasionally, with the redundant architecture preventing impact to operations. As such, the early problems with redundancy events are

This report has been developed under a privileged and confidential assignment on behalf of the City of Ottawa. While the report has been prepared for release to City Council as requested by the City and counsel to the City, neither the City nor its' counsel waive privilege over the overall assignment.

considered to be start-up problems of the CBTC system and current occurrence rates are considered normal.

**Figure 3.47: Redundancy Events (ZC, LSRS, CSRS or ATS Operating on Backup System)**



Source: Mott MacDonald, based on incident logs provided by the City.

### 3.2.4.6 Conclusion

Analysis of the performance of the CBTC system reveals that the system has experienced various start-up problems after operation commenced but the frequency of these problems has since reduced. Thales has provided software updates (Version 7.0 installed in October 2020) to further improve the performance of the system, which reflects typical practice. The CBTC system is considered to perform as intended.

## 4 Recommendations – Track and Rail Systems

The list below is a summary of the recommendations made in this Volume, grouped by priority to identify those tasks we believe that Project Co should undertake immediately and those which could be completed in the medium-term.

### 4.1 Rail and Track Structure

#### 4.1.1 Priority

It is recommended that:

1. RNT-risk susceptible areas such as stress transition zones, or areas where track movements have occurred, or may occur, be identified.
2. Short-term mitigation measures should be determined and implemented in RNT-risk susceptible areas, including increasing ballast shoulders, widening of the ballast shoulder and/or installation of tie anchors (not to be confused with rail anchors) to increase the lateral track resistance.
3. A season-based approach to restressing of the track should be implemented in RNT-risk susceptible areas, to mitigate the challenge regarding heat expansion and sun kinks.
4. “Critical Rail Temperature Management,” employing smart infrastructure monitoring by using rail mounted probes that provide real time reporting and automatically register when intervention limits are being reached thus triggering messages sent directly to maintenance teams and drivers to inform them of any speed restrictions, should be considered at RNT-risk susceptible areas or areas where works have been undertaken and ballast is yet to consolidate.
5. Where restraining, or “continuous check rails,” are employed through curves they should be extended to terminate at least 3m into straight track.
6. Measurement of corrugation should be undertaken on the whole System using a “Rail Measurement Corrugation Analysis Trolley” or similar that allows the location, depth and wavelength to be reported.
7. Analysis of corrugation as measured above and assess whether another round of rail grinding should be undertaken in the short term.
8. Measurement of corrugation as well as inspection for it should be included in the maintenance regime and undertaken more frequently, at least every three months, to allow an understanding of where corrugation is forming and the growth rates. This can be used to inform a proactive program of rail grinding. Once the growth of corrugation is established the frequency of measurement could potentially be reduced.
9. A visual and ultrasonic inspection of the wheel burn defects should be undertaken to confirm if any cracks are present.
10. A survey should be undertaken of the entire line to determine if rolling contact fatigue is present, and the severity. Ideally this would involve both ultrasonic inspection and, for short cracks, eddy current testing. If this is not possible within a short time frame, then visual inspection with the aid of Magnetic Particle Inspection should be carried out.

### 4.1.2 Rail and Track Structure – Other Design and Maintenance

It is recommended that:

1. Installation of adjustment switches could be considered in RNT-risk susceptible locations.
2. The joints at the Rideau River Bridge have not been installed in accordance with Good Industry Practice, as such the inner blades should be repositioned, and pointed in the direction of traffic or primary traffic direction.
3. To determine if Project Co is meeting the PA with regard to nuisance to neighbours, track based (pass by) noise monitoring should be undertaken at the locations where corrugation is present prior to grinding.
4. Removal of the wheel burn defects by grinding and weld repair of the rail surface or rail replacement should be undertaken.
5. A detailed wheel/rail interaction study should be undertaken to determine if the optimal wheel and rail profiles are being used. This study should seek to optimize the wheel and rail profile to minimize rail/wheel damage by ensuring good steering through curves while minimizing hunting. The study should also consider if changes to the track or vehicle would be beneficial. As well as new profiles, it should also consider how these develop with wear over time. It should also consider whether the existing lubrication is sufficient or whether trackside lubricators are required given the high levels of wear.

## 4.2 Rail Systems (OCS and Traction Power)

### 4.2.1 Priority

For OCS, it is recommended that Project Co review the design of the following, which do not appear to be in alignment with Good Industry Practice, as it is defined in the Project Agreement:

Messenger wire

1. It is recommended that messenger wires be bonded to the aluminium OCR at all OCS to OCR transitions, at both downtown tunnel portals and on both side of St-Laurent station over both tracks.
2. It is recommended that the messenger wires be bonded on both tracks. The bonds installed should provide, as a minimum, equal ampacity to the messenger wire.
3. It is recommended that a second full-section or a MW to MW jumper is installed to provide equivalent ampacity of the sections of OCS.

Wire heights and staggers

4. To reduce the likelihood of a hook-over occurring, the contact wire heights should be checked and adjusted to ensure that the correct take-over as the pantograph traverses the wires

Jumper wires

5. To reduce the likelihood of a failure, the existing installation should be checked, and additional jumpers installed as necessary

Feeder connections

6. Updated data and ongoing performance monitoring records be provided, to verify whether the changes made under the Project Co Rectification Plan have solved the issues as intended. This should include written feedback as to the status and details of any changes made.

Section insulators

7. At the ends of the SI, the contact wire and runners should be set at the same height with consistent wear on all three elements, to provide a smooth transition from the contact wire to the runners or vice versa.
8. Whilst it is not possible to eliminate the risk of a failure, due to other factors such as the pantograph, track and vehicle, to reduce the likelihood of a failure of the section insulator and reduced damage to equipment, the section insulators should be checked and adjusted as necessary using a dummy pantograph fitted to the maintenance vehicle.

#### Crossover/mainline contact wire transition

9. A full survey of the crossover/mainline wires should be carried out and heights adjusted accordingly to provide a smooth transition.

#### Rigid rail overlaps in tunnels

10. A full survey of the overlaps in the tunnels should be carried out and heights adjusted accordingly to provide a smooth transition.

#### Balance weights

11. A full survey of the balance weight assembly should be carried out and analysis carried out to determine if travel between the two stops is enough and the weight heights are set correctly.
12. Specific information for each remedial or maintenance activity, detailing what is to be recorded, and what should be developed and added to existing check sheets in order to ensure the information gained is useful to allow for any future review and analysis to be undertaken.

#### For Traction Power, it is recommended that:

1. Project Co acknowledge issues with Stray Current and Rail overvoltage as specific items to be addressed in the Remediation Action Plan.
2. Project Co, based on excess stray current reports by Enbridge Gas, embark on an immediate program of remediation focussing on grounding and bonding principles deployed around the network. This should verify the status of unmonitored VLD-F and VLD-O type overvoltage protection devices, should verify track insulation levels (rail to ground testing) and carry out bonding inspections to ensure there are no direct bonding connections that could be affecting system insulation levels.
3. Project Co review and carefully consider how high accessible voltages at the rails, and the frequent operation of negative grounding devices in response, could be impacting stray current levels at adjacent utilities, and provide documentary evidence of this review and consideration to the City.
4. Project Co provide a specific review and assessment identifying how the TPS system interfaces with other disciplines, particularly when it comes to establishing clearance zones and risk assessments, i.e., allowing clearance and risk assessment processes to drive decisions regarding grounding and bonding protection measures with regard to separation, segregation, insulation, and over-voltage protection.
5. TPSS Negative Grounding Devices – Investigate the root causes behind frequent operation of NGD devices at TPSS. Is this an indicator of systemic rail/accessible over-voltage or equipment issues. Carry out the necessary system level tests to investigate systemic rail/accessible voltage performance. Investigate if or how this may be contributing to stray current issues with the utilities. (This should be considered in conjunction with rail accessible voltage testing, Item 8 below.)
6. Stray Currents at Adjacent Utilities – In collaboration with the stray current working group, develop and execute a remediation plan to correct the stray current issues reported by the City of Ottawa in interface meeting of 22-04-21 and in a following up meeting in July 2021. It

was also recommended that Project Co respond to Mott MacDonald's request for stray current data submitted by RFI, although we note the current NCR #802 where stray current baseline and verification data to the PA has not been supplied. (See RFI log in Volume 7.)

7. Stray Current Monitoring – The reporting of excess stray current at some of the adjacent utilities as advised by the City of Ottawa, may suggest that some attention is required towards pro-active data collection and analysis of TPSS telemetry and reporting of stray current issues by adjacent utilities. While clear principles have been set out for this in supporting design information within the grounding and bonding sub-system, the lack of data provided in response to Mott MacDonald's request for stray current monitoring data may suggest that not enough attention is being paid to gathering, analyzing and acting upon data trends for stray current performance. (The existence of NCR #802 would reinforce this position.) For a network in early life operation, it should be expected that a footprint test has been completed at entry into operational service and within two years of entry into service. This data should be readily available.
8. Arcing event of 05-03-21 at LRV-1117/Parliament Station – In response to the arcing event of 05-03-21, it is recommended that Project Co carry out an analysis of clearance and the suitability of ground and bonding measures at the location of the event e.g., at Parliament Station. Have VLD-O devices been suitably deployed to manage electrical safety at the station locations? This issue has opened up wider the concerns Project Co has regarding high accessible rail volts. Mott MacDonald understands in response to this that Project Co has prioritized safety by closing the NGD at TPSS. This decision, while on balance is clearly the right one over the concerns noted, does have consequences in the form of promoting stray current leakage from the network. There is some evidence that this is already having impact on the adjacent utilities. We recommended that some urgency is placed on remediating over-voltage protection at critical human interfaces like stations so that the NGD are put back into normal operation at the earliest opportunity. (This should be considered in conjunction with rail accessible voltage testing below.)
9. System Performance for Rail Accessible Voltage and Grounding and Bonding Principles – Over concerns with frequent operation of NGD at several TPSS around the network and recent concerns that Project Co has evidenced themselves regarding levels of rail voltage we recommended that Project Co does some network wide testing to profile rail volts. This would need to be done with the NGD open and Mott MacDonald recognize that is problematic given the arcing event of 05-03-21 and concerns regarding over-volts protection. It may be necessary to provide remediation of over-volts protection at stations to ensure the safety of the public during this type of testing. The alternative would be to run a shadow service out of normal hours. Mott MacDonald would suggest this testing is necessary, (unless Project Co can provide data in lieu of this) as it will provide insights into system performance for rail volts, reasons for frequent NGD operation around the network, the arcing event at Parliament and rail voltage impact on stray current performance. Mott MacDonald would also recommend that a wider review of grounding and bonding measures across the network is carried out.
10. TPSS06 Frame Leakage Faults – It is recommended that Project Co carry out a detailed review of insulation coordination at the TPSS06 DC switchgear panel to eliminate the relatively high number of high priority events that have resulted over frame faults. Noting that Project Co has eliminated protection equipment faults as the root cause Mott MacDonald recommended that some limited inspection and insulation testing is carried out to resolve this issue. It was also recommended that Project Co investigate the high levels of moisture present in this substation, and also as noted in substation TPSS02, as being a contributory factor to this type of repeating event.



#### 4.2.2 Rail Systems – Other Recommendations

It is recommended:

##### OCS/Section Insulators

1. That all section insulators installation be checked and maintained in accordance with manufacturers instructions.
2. OCS/Balance Weight Anchors
  - a. A survey of all the balance weight anchors be carried out to determine the as-built configuration, with further inspections, including measurements of:
    - i. The weight stacks from a fixed datum, not ground level as this can change over time.
    - ii. The distance between the stop and pulley wheel. This is critical to the operation of the stop, to prevent the weights from crashing to the floor/high temperature stop, in the event of a wire failure.
    - iii. Check wires on and off the pulley drums, especially for rubbing the sides of the pullies.
    - iv. Check movement of the pullies.
    - v. Ensure all defects are noted, including loose fixings.
3. It is reported, in the ALLTRADE/CYMI maintenance report that several U-bolts are rusty. If not already instigated, a further inspections/investigation should be carried out to determine the extent of the corrosion and if they need to be replaced

##### Traction Power

1. Project Co confirm the actions they have taken to reduce the frequency of tripping events for TPSS switchgear.
2. Project Co review its grounding and bonding principles noting their own concerns relating to generally high accessible rail voltages around the network and the systemwide response to the arcing event at LRV-1117/Parliament Station.
3. Project Co review its stray current monitoring strategy, firstly to establish a baseline and resolve NCR #802 item. (Prior to this the network must be restored to normal operation. In this context we refer to restoring NGD devices at TPSS to normally open position.) It was also recommended that Project Co be consistent in carrying out periodic stray current monitoring and reporting in accordance with the Project Agreement.

##### GIDS

1. Further definition of requirements – including object speed and operational window be completed.
2. Project Co provide details of installation, configuration and testing – including test pass / fail criteria, test cases and evidence of compliance with the design.
3. Project Co review the current installation and configuration against the further defined requirements so that the instances of “false positives” can be further reduced.

##### SCADA

4. Project Co develop alarm strategy that includes differentiation of events, indications, alarms.
5. Project Co develop requirements alarm management and handling strategies.

6. Project Co consult with Users/Operators for the development of the alarm strategy, alarm management and handling requirements.
7. Project Co agreement with Users/Operators who will be responsible for review events, indications (e.g., Operators) and who will be responsible for actioning alarms (e.g., Maintainers).
8. Project Co complete root cause investigation of the highest three broad categories of alarms, including a review of the interfacing systems faults and configurations.
9. Project Co engage with Human Factors and Ergonomics specialists to assess the volume of alarms, the type of alarms, the number of User/Operator workstations.

# **Volume 4: Belfast Yard Maintenance and Storage Facility**

April, 2022  
Confidential

# Contents

|  |           |
|--|-----------|
| Belfast Yard MSF Summary   | v         |
| Introduction to Volume 4   | vi        |
| 2.1 Approach   | vi        |
| 2.2 Document Review  | vi        |
| <b>3 Desktop Survey/Review of MSF Design</b>                             | <b>90</b> |
| 3.1 General Context  | 90        |
| 3.2 Analysis of Track Layout supporting functionality required by the PA | 90        |
| 3.3 Fleet Maintenance Equipment  | 92        |
| 3.4 Asset Management Plans   | 92        |
| 3.5 Fleet Maintenance Area   | 93        |
| 3.5.1 MSF1   | 93        |
| 3.5.2 Track and Floor Workspace Functions                                | 93        |
| 3.6 MSF2   | 95        |
| 3.7 Vehicle Storage Shed   | 97        |
| <b>4 MSF Physical Inspection</b>   | <b>99</b> |
| 4.1 MSF 1  | 99        |
| 4.2 Tracks 7 and 8   | 105       |
| 4.2.1 Maintenance Supervisor Office within MSF1:                         | 108       |
| 4.2.2 Vehicle Storage Shed   | 108       |
| 4.2.3 Test Vehicles in Storage Shed                                      | 112       |
| 4.3 MSF Yard Area  | 116       |
| 4.3.1 Signalling system and ATO still not operative in yard.             | 116       |
| 4.3.2 Grease on top of rail  | 116       |
| 4.4 Track  | 118       |
| 4.4.1 Sample Track Measurements  | 118       |
| 4.4.2 Curves C10, 12 and 13  | 120       |
| 4.4.3 Curve C17  | 120       |
| 4.4.4 Curves C18, 19 and 20  | 120       |
| 4.4.5 Curves C22 and 25  | 120       |
| 4.4.6 Eastbound Connector  | 120       |
| 4.4.7 Westbound Connector  | 121       |
| 4.4.8 Track Condition Review   | 121       |
| 4.4.9 Rail Wear  | 122       |
| 4.4.10 Other   | 123       |
| 4.4.11 Summary of Other Findings   | 123       |
| 4.4.12 Wheel Truing  | 124       |

|          |   |            |
|----------|---|------------|
| 4.4.13   | Wheel Lathe Calibration                               | 127        |
| 4.4.14   | Wheel Flange Lubrication                              | 127        |
| 4.4.15   | Work Order Process and Visibility                     | 129        |
| <b>5</b> | <b>Incidents within the MSF</b>                       | <b>131</b> |
| 5.1      | Incident Investigation Reports                        | 131        |
| 5.1.1    | Derailment at Curve 19 on Track 15 (October 18, 2020) | 131        |
| 5.1.2    | Derailment at East Connector (November 18, 2020)      | 134        |
| <b>6</b> | <b>Conclusions MSF</b>                                | <b>140</b> |
| 6.1      | Track Condition and Geometry                          | 140        |
| 6.2      | Vehicle Storage Shed                                  | 140        |
| 6.3      | Trackwork Loop  | 140        |
| 6.4      | Movement Constraints                                  | 141        |
| 6.5      | Miscellaneous Equipment Faults                        | 141        |
| 6.6      | Operational Processes                                 | 141        |
| 6.7      | Asset Management Plan                                 | 141        |
| 6.8      | Revenue Vehicle Maintenance Processes                 | 142        |
| 6.9      | Incidents within the MSF                              | 142        |
| <b>7</b> | <b>Recommendations - MSF</b>                          | <b>143</b> |
| 7.1      | Priority Recommendations                              | 143        |
| 7.2      | Additional Recommendation                             | 143        |

## Tables

|   |    |
|---|----|
| Table 3.3: Current MSF Industrial Equipment | 92 |
|---|----|

## Figures

|  |     |
|--|-----|
| Figure 3.48: MSF Layout  | 90  |
| Figure 3.49: Recommended possible direct train movements within an MSF                       | 91  |
| Figure 3.50: MSF1 Layout   | 93  |
| Figure 3-51: View of Tracks 2 and 3 of MSF1  | 94  |
| Figure 3.52: MSF2 Layout   | 96  |
| Figure 3.53: Vehicle Lifted by Portable Jacks at MSF2  | 96  |
| Figure 3.54: Truck Work Area at MSF2   | 97  |
| Figure 3.55: Storage Shed  | 97  |
| Figure 4.1: (a) (b) (c) (d): Parts Laying Out on the Floor Shop of MSF1 Next to Tracks 1 – 4 | 101 |
| Figure 4.2: View of LMB1 at MSF1   | 102 |
| Figure 4.3: Restricted Access to Mezzanine Area of LMB 1 and 2                               | 103 |
| Figure 4.4: MSF1 Access Issue to LMBs 1 and 2 When a Vehicle is Outside the SIW Bay          | 103 |
| Figure 4.5: MSF1 Access Issue to LMB 1 and 2 from East Side of Facility                      | 105 |

|   |     |
|---|-----|
| Figure 4.6: Sanding Pump at Track #7  | 106 |
| Figure 4.7: Carwash System at MSF1  | 107 |
| Figure 4.8: Other Potential Vehicle Launch Tracks   | 109 |
| Figure 4.9: Dividing Fence at Storage Shed and Limited Staff Access Between Tracks with No Walkway                            | 109 |
| Figure 4.10: Dividing Fence at Storage Shed with No Staff Access or Safety Clearance  | 110 |
| Figure 4.11: Limited Space Available Between Vehicles at the Storage Shed   | 111 |
| Figure 4.12: Lack of Doors at Storage Shed  | 112 |
| Figure 4.13: Vehicle Missing Side Panels, Coupler, Skirts and Roof Shrouds  | 113 |
| Figure 4.14: Vehicle Missing Passenger Interior Components  | 114 |
| Figure 4.15: Vehicle Missing Trucks   | 115 |
| Figure 4.16: Crates in MSF1 Labelled "REMOVED FROM TS 8"  | 116 |
| Figure 4.17: Grease Contamination at East Connector   | 117 |
| Figure 4.18: Grease on Top of Rail at East Connector  | 117 |
| Figure 4.19: Sand accumulated at East Connector Due to Excessive Wheel Spin/Slide Caused by Presence of Grease on Top of Rail | 118 |
| Figure 4.20: Sample Track Measurements  | 119 |
| Figure 4.21: Kinks at Weld Location (C19), Including Grease Contamination of the Top of Rail                                  | 120 |
| Figure 4.22: Sand accumulated at East Connector Due to Excessive Wheel Spin/Slide Caused by Presence of Grease on Top of Rail | 121 |
| Figure 4.23: EB Connector, Track Geometry at Interface Between Ballast Track and DFF Track                                    | 122 |
| Figure 4.24: Grooved Wear on Pantograph   | 124 |
| Figure 4.25: Excerpt from RTG-OTT-00-0-LET-1035 - Independent Expert Review - Update and Next Steps                           | 126 |
| Figure 4.26: Hegenscheidt U2000-150D Underfloor Wheel Lathe   | 128 |
| Figure 4.27: Wheel Flange Lubrication Location  | 129 |
| Figure 4.28: Work Order History Display   | 130 |
| Figure 5.1: Metal Shavings Along Rail Curve 19  | 131 |
| Figure 5.2: Transposed Rail with Excessive Side Wear Now Moved to the Outside Edge  | 132 |
| Figure 5.3 & 5.4: Metal Shavings at Curve 19  | 133 |
| Figure 5.5: Wheel Flange Lubricator   | 134 |
| Figure 5.6: Manual Grease Application Location at East Connector Tunnel   | 135 |
| Figure 5.7: Grease on Rail Crown at Manual Grease Application Location  | 136 |
| Figure 5.8: Less Grease on Rail Elsewhere in the Connector Tunnel   | 136 |
| Figure 5.9: Sand in East Connector Portal Tunnel  | 137 |
| Figure 5.10: Metal Shaving at East Connector Portal Tunnel  | 138 |
| Figure 5.11: Track Geometry as Reported in Alstom Incident Report TN-024  | 139 |

# Belfast Yard MSF Summary

The purpose of this Volume is to summarize Mott MacDonald's evaluation of the Belfast Road MSF ability to operate successfully as the LRV fleet number is increased during Stage 2 of the project, as well as documenting the conditions and potential issues seen in relation to the derailments within the MSF facility and elsewhere.

The MSF appears to have been designed and constructed in general accordance with the PA Schedule 15. However, it should be noted that PA Schedule 15 is structured as an output specification, which is typical of AFP projects, but as such does not include or identify specific requirements for the MSF other than the need for the MSF to be designed, built and maintained by Project Co and that the MSF is to provide for the maintenance of the systems vehicle fleet.

Further, the maintenance areas appear to be reasonably equipped to perform the running type maintenance for the fleet. There are areas set aside for bench test equipment, welding, purpose build bogie stands, lifting jacks and specialized shunting machines to move the trains within the MSFs if required. Similarly, both MSF1 and MSF2 have areas where the overhead power can be provided to the train and the area isolated from workers not approved to be in that location, and both the MSFs also contain overhead cranes that can be used for lifting and moving equipment around the facility. MSF1 and MSF2 locations had good lighting, end doors in the maintenance building and air ventilation in operation during our visit.

However, while the MSF may have been designed and constructed in general accordance with PA Schedule 15-2 and appears to have the required equipment and facilities to support the required operation for running type maintenance; however, Mott MacDonald has identified several opportunities for improvement as they apply to Good Industry Practice that could be applied to the design and operation of this type of facility. These include:

## Good Industry Practice in Design and Construction:

- Track Condition and Geometry
- Vehicle Storage Shed
- Trackwork Loop
- Miscellaneous Equipment Faults

## Good Industry Practice as it applies to Maintenance and Operations

- Movement Constraints
- Operational Processes
- Asset Management Plan
- Revenue Vehicle Maintenance Processes
- Incidents within the MSF

Our priority recommendations as they apply to the facilities, equipment and operation of the MSF are captured later in this Volume and collated with the recommendations from all Volumes in Volume 6.



# Introduction to Volume 4

The purpose of this Volume is to summarize Mott MacDonald's findings regarding the priority review of the Belfast Yard MSF as well as providing a summary of recommended changes or repairs or upgrades that are required to improve the performance of the Project systems, and Project Operations and Maintenance.

## 2.1 Approach

As part of the Independent Review, Mott MacDonald reviewed the Belfast Road MSF and evaluated the physical infrastructure as well as the process for planning, preparing and executing the servicing, maintenance and operation of the vehicles as required for continuing operation of the Project. In addition, the MSF review also included physical site inspections to inspect, measure and record track gauge dimensions within the yard and the tunnel outlet where the MSF lead tracks connect with the mainline, as some of these locations have had more than one derailment occurring since the facility has operated trains.

Mott MacDonald conducted a review of available background material, and assessed failures/issues against defined City requirements as well as Project Co derived requirements, investigated the design, and validated remedial activities implemented. The approach also included meetings with City and Project Co staff, where needed, and included site visits conducted in July and August 2021. Early-stage investigations were then used to guide later stages of the study when more in depth data collection, and site reviews and assessments, were carried out.

The result of the review included Mott MacDonald's determination of required interventions, to identify actions against sources of unreliability, and deliver maximum benefit to System performance in the least amount of time.

## 2.2 Document Review

The document review included Project Agreement and project specification requirements for this specific area. Thirty (30) document requests were tracked via a Mott MacDonald's RFI log, which is included in Volume 7. At this time, responses to RFIs submitted to Project Co on these issues remain outstanding, and this remains an area of concern. These include the following RFIs:

- Track RFI 016
- Rail Systems RFI 010, 012, 019, 022, 024

Mott MacDonald also requested access to Project Co's Asset Management Plan, required per Schedule 15-3 of the Project Agreement, Appendix B, Asset Preservation (Asset Management Plan).

The specific impact of the lack of response is difficult to define, as it changes for the specifics of each case. In many cases the requests were to provide documentary evidence or proof that a proposed rectification has, in fact, been undertaken and/or how the works aligns with the Rectification Plan schedules. In the absence of documentary evidence Mott MacDonald has worked to provide our assessment of whether the proposed rectification was likely to mitigate the given issue, but our opinion is subject to change should requested documents or other updated information be provided.

# 3 Desktop Survey/Review of MSF Design

## 3.1 General Context

Below is a high-level summary of the topics and items reviewed as part of the desktop review of the MSF design (Figure 3.48).

Mott MacDonald reviewed:

- The layout/track alignment requirements in the PA
- If the track layout appears to support functionality required by the PA
- From a “first principles” view, does Mott MacDonald agree that the equipment available at the MSF support the maintenance requirements for a fleet currently required on the Confederation Line
- If there has been sufficient area made available to do all reasonable cleaning, servicing and maintenance in the layout and design of the MSF
- Is the maintenance provider making use of the correct tools and equipment to complete the tasks required in the PA

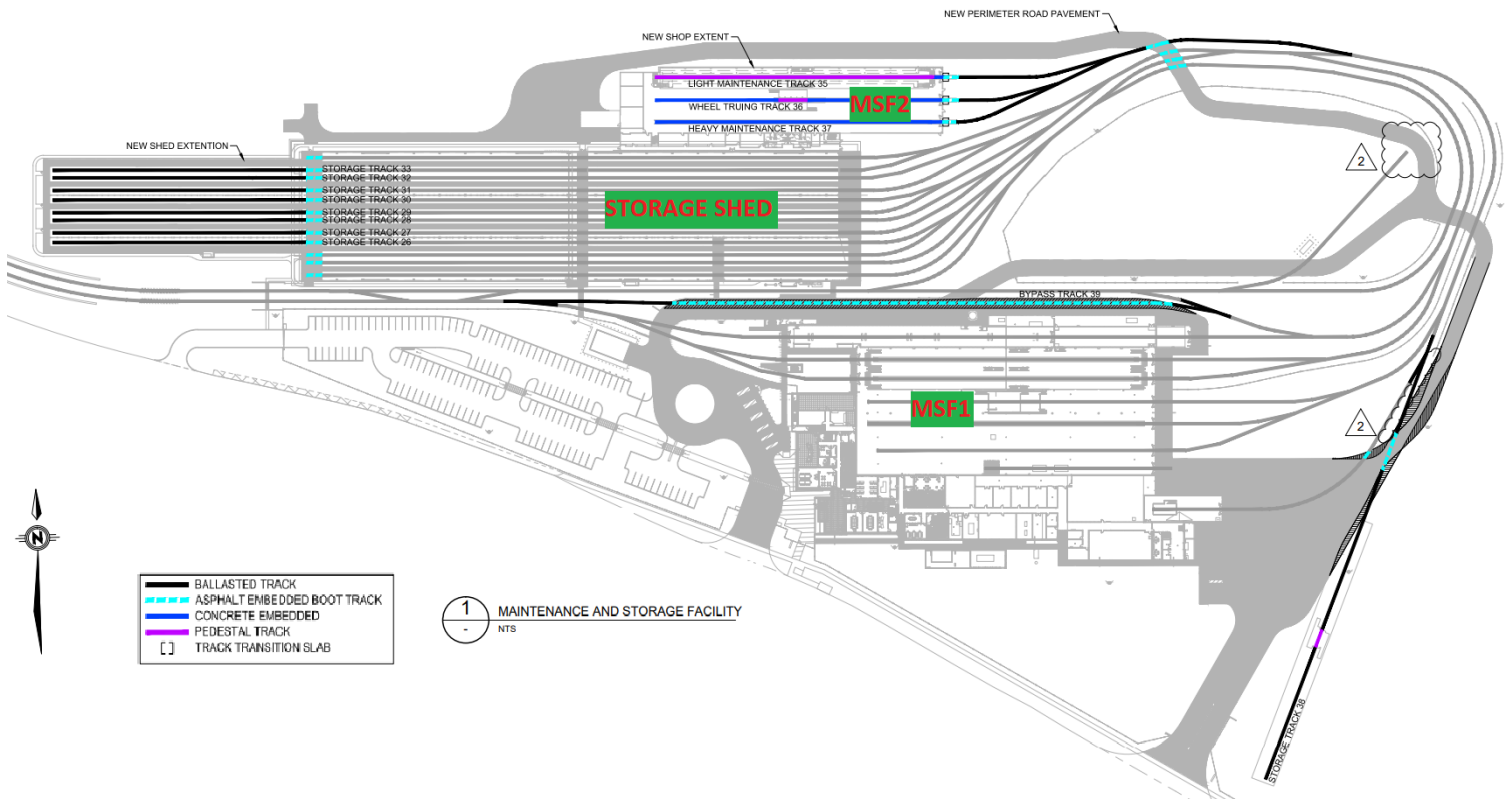


Figure 3.48: MSF Layout

## 3.2 Analysis of Track Layout supporting functionality required by the PA

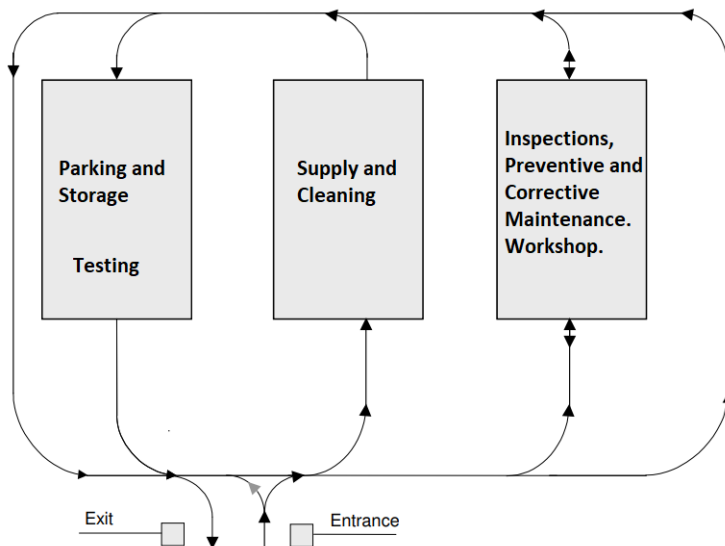
Schedule 15 – 2 of the PA refers to Design and Construction Requirements. Part 1, under Article 1 – Physical Layout, 1.1 Project Description, c) there is a statement that “An MSF shall be provided...” and that the facility shall contain “every requirement for the Maintenance and storage of the vehicles.” Also

under Article 1 of this section of the PA, in 1.5 Facilities Requirements, a) MSF Requirements (ii) “*Project Co shall be responsible for ...all equipment and facilities to maintain the Vehicles to meet the requirements of this Schedule 15 Output Specifications.*” Within Schedule 15 – 2 Part 1, Article 1, 1.8, b), (viii) there is a reference to “*Future expansion of the MSF*” that Project Co shall protect for. As noted further in the following sections, there are concerns that the MSF will not be able to meet the needs of the larger fleet when Stage 2 of the line is operational.

Schedule 15 – 2 Part 6 refers directly to the Design and Construction Requirements – MSF. This part of the PA deals with the MSF construction and to a lesser extent, the function that the MSF must be able to perform. For instance, Schedule 15 – 2 Part 6, 6.5 Track Materials, (c) Restraining Rails, (i) “*Project Co shall install retaining rails against the gauge side of the low rail for all mainline horizontal curves with a radius of 145m or less.*” As of the time this report was issued, this requirement appears to have been met for the mainline but has not been applied to the MSF yard track which has curves of a much tighter radius than the mainline, therefore this needs to be evaluated further in order to mitigate the potential risk of further instances of in-yard derailment occurring.

It should be noted that PA Schedule 15 is structured as an output specification, which is typical of AFP projects, but as such does not include or identify detailed requirements for the MSF other than the need for the MSF to be designed, built and maintained by Project Co and that the MSF is to provide for the maintenance of the systems vehicle fleet.

One of the main challenges presented by the yard and shop layout design is the lack of a circular track loop and operational flexibility/redundancy within the current layout as it requires the need to carryout numerous reverse vehicle movements. This makes vehicle movements more difficult especially when there are operational irregularities and potential conflicting movements between maintenance and operations and could lead to conflicting moves and potential risk of derailments. A circular track loop would allow for efficient flow of vehicles when launching the service and on its return for servicing and maintenance and minimizing train and personnel movements. According to the German VDV Recommendation on the Design of Depots for LRVs and Tramcars, the direct possibilities of train movements indicated in **Figure 3.49** should be possible within a well-designed MSF. These movements are not possible at the current Ottawa LRT MSF.



It is important to note that the German VDV Recommendation on the Design of Depots for LRVs and Tramcars is used globally including North America and is recognized as an example of Good Industry Practice for this type of light rail application.

**Figure 3.49: Recommended possible direct train movements within an MSF**

There are many examples of light rail MSF applications in North America where the circular loop arrangement has been used to maximize operational flexibility and redundancy, although it is noted that space constraints in the Belfast Yard would have impacted the design and layout choices made by Project Co.

### 3.3 Fleet Maintenance Equipment

Both MSF1 and MSF2 maintenance areas appears to be well equipped to perform the running type maintenance for the fleet. There are areas set aside for bench test equipment, welding, purpose build bogie stands, lifting jacks and specialized battery-operated shunting machines to move the trains within the MSFs if required. Both MSF1 and MSF2 have areas where the overhead power can be provided to the train and the area isolated from workers not approved to be in that location. Both the MSFs also contain overhead cranes that can be used for lifting and moving equipment around the facility. MSF1 and MSF2 locations had good lighting, workshop end doors and air ventilation in operation during our visit.

Table 3.3 provides a list of the main industrial equipment at the MSF.

**Table 3.3: Current MSF Industrial Equipment**

| Item No. | MSF – Main Equipment Description | Qty.                       | Location (Track #)                            | Comments   |
|----------|----------------------------------|----------------------------|---|--|
| 1        | Portable jacks                   | 3 sets                     | MSF1 Track 2<br>MSF2 Tracks 35&37             | MSF1 set not commissioned at the time of this inspection |
| 2        | Overhead cranes and hoists       | 12t x2<br>3t x1<br>5.5t x1 | MSF1 Tracks 1-3<br>MSF1 Track 4<br>MSF2 Track |  |
| 3        | Car wash system                  | 1                          | MSF1 Track 8                                  |  |
| 4        | Sanding system                   | 1                          | MSF1 Track 7                                  | Out of service at the time of this inspection            |
| 5        | Battery powered shunter          | 1                          | MSF1  |  |
| 6        | Underfloor wheel lathe           | 2                          | MSF2 Track 36<br>Storage Track 38             |  |
| 7        | Truck assembly benches           | 6                          | Between Tracks 35 & 36                        |  |
| 8        | Forklifts                        | 1                          |   |  |

### 3.4 Asset Management Plans

Before attending the MSF site in August 2021, the Mott MacDonald team made requests to the City of Ottawa for information regarding the requirements in Schedule 15-3 of the Project Agreement, Appendix B, Asset Preservation. Within this Schedule, Project Co is responsible for meeting the objective of supplying a “sound Asset Management Plan.” The Mott MacDonald team requested a copy of the AMP as it has been Good Industry Practice for many years to develop and implement asset management plans following the guidelines set out in ISO 55000. The City had previously provided a copy of Project Co’s document RTM-MC-PLN-459, titled “Confederation Line Asset Management Plan,” dated 2019-04-12 but no further updates to this document have been supplied by Project Co, or reviewed by Mott MacDonald. In this document there is missing information and the document identified that it will be updated and reissued within one year.

ISO 55000:2014 is the current revision of the industry standard for Asset Management and has been available for public use since 2004 when the document was published as PAS55. There are currently three international standards available for asset management:

- ISO 55000:2014 Asset management – Overview, principles and terminology
- ISO 55001:2014 Asset management – Management Systems – Requirements
- ISO 55002:2018 Guidelines for the application of ISO 55001

ISO 55000 was launched in February 2014 and was used prior to this via PAS55. The methodology in PAS55 was further developed into the ISO 55000 documents and have been used extensively in the rail industry and by government bodies around the world.

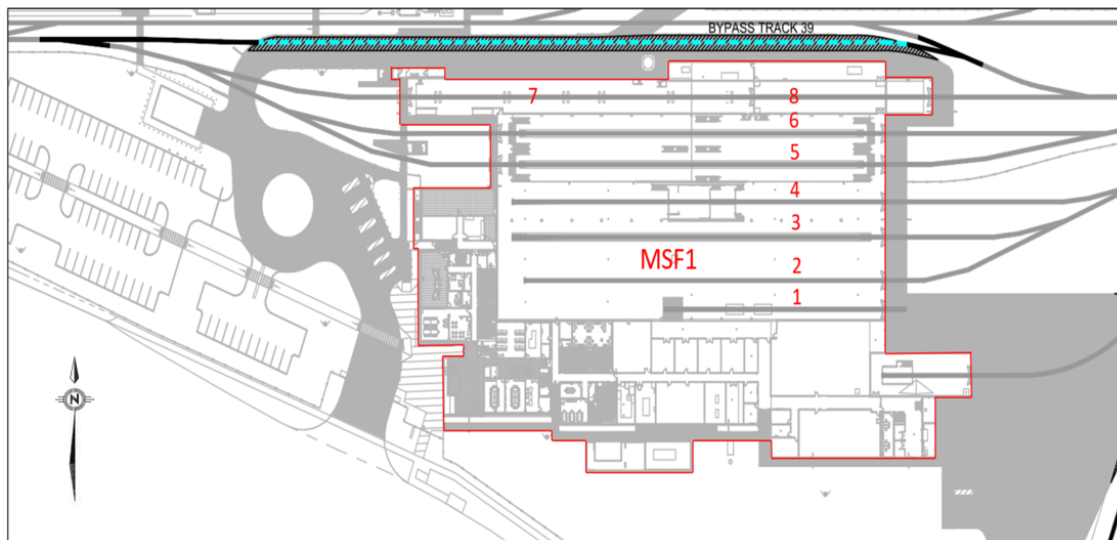
During the visit to the MSF, the Mott MacDonald team asked about the updated AMP and were informed that the plan is not yet complete but would be available soon. At the time of writing this report an up-to-date AMP has not been received from Project Co. The AMP should be updated and reviewed in accordance with the PA and as the project develops and progresses through its lifecycle. The AMP would help Project Co and its suppliers meet the requirements of the City and show a clear path of how Project Co is ensuring that the City's assets are being managed and maintained.

Project Co. would benefit from having a strong AMP in place that is updated every year based on asset performance, condition and risks faced by the system. With so many changes happening to the vehicles themselves this may be difficult to keep track of vehicle condition in accordance with the AMP and it appears this has not been undertaken. The PA sets out to have Project Co., the Asset Manager, reporting back to the City, the Asset Owner, across various categories and, with this information, the Asset Owner could then monitor and react accordingly. In the shorter term, items such as the system safety, risks and train service needs are for the attention of the Asset Manager, who in turn should be reporting this on a regular basis to the asset owner.

### 3.5 Fleet Maintenance Area

#### 3.5.1 MSF1

The MSF1 is used for light maintenance activities, inspections, retrofits, component exchange, commissioning, filling on-board sanding boxes, and washing vehicles (**Figure 3.50**).



**Figure 3.50: MSF1 Layout**

#### 3.5.2 Track and Floor Workspace Functions

The facility consists of eight tracks, each of which has the following current functions.

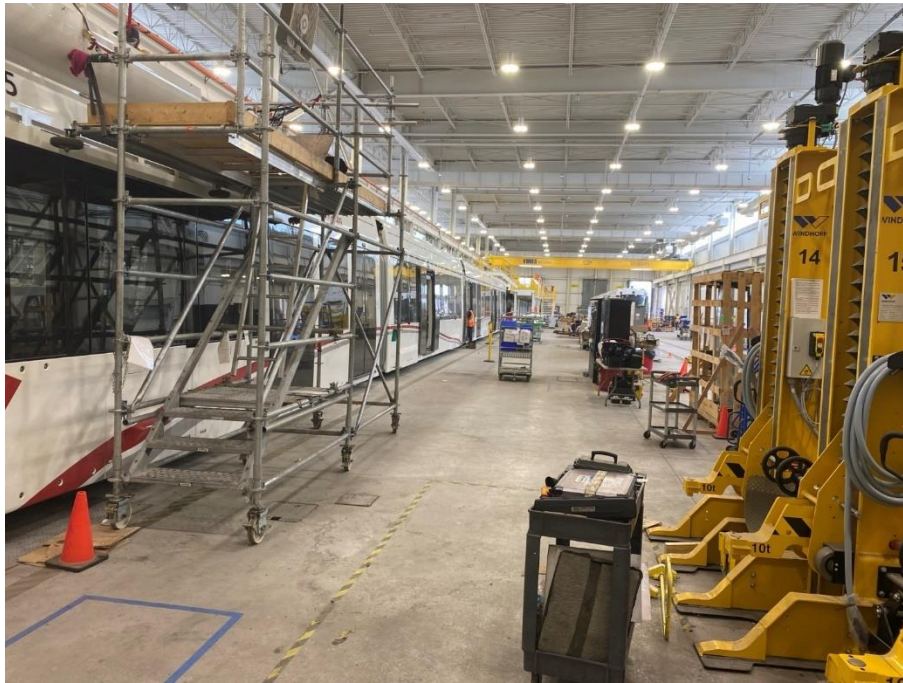
##### 3.5.2.1 Tracks 1 – 4

Tracks 1 – 4 are stub ended tracks, they can only be accessed from the east side of the facility.



The four stub ended tracks do not have OCS power, these tracks are used primarily for retrofit/modification work, to remove and install components on vehicles, to close open items from vehicles received from Alstom's plant in Brampton, ON, and for maintenance activities associated to maintenance of wayside equipment.

A battery-powered shunter is available to move vehicles in and out of the facility. There are two 12 tonne overhead cranes available to tracks 1 to 3 and one 3-tonne overhead crane on track 4. There is a set of movable jacks that have not been commissioned which can be utilized to lift an LRV to perform work such as changing a truck. However, it is not known if the proposed areas for the movable jacks to be used have been assessed to confirm if the floor has been designed to support the weight of the lifting jacks and a complete vehicle. Also, it is necessary for the jacks and the control console to each have a power supply socket, usually mounted in an access box located close to the floor area adjacent to the area of operation. It is recommended the floor areas and available power supplies are assessed to ensure their suitability for conducting vehicle lifting activities. On the east side of track 3 there is a train roof access platform, and there is also a movable scaffolding which allows for roof work without mezzanine. However, it is not apparent whether there is a means of interlocking and isolating the overhead travelling crane to prevent it moving in the areas where the movable scaffold is being used.



**Figure 3.51: View of Tracks 2 and 3 of MSF1**

### 3.5.2.2 Tracks 5 and 6

Light Maintenance Bays 1 and 2, located on tracks 5 and 6, are used for light maintenance activities and examinations. These tracks have access from the west and east sides of the shop. From the west side, vehicles returning from revenue service can access the maintenance bays, and on the east side the tracks connect to the yard and storage shed. Each track has space for only two vehicles, therefore has limited capacity to conduct light maintenance activities and examinations, especially considering the additional vehicles from Stage 2 that are expected to enter revenue service.

### 3.5.2.3 Tracks 7 and 8

The sanding system and carwash system are located on tracks 7 and 8 SIW respectively. In addition to filling on-board sandboxes, and washing vehicles, the SIW bay is also used to perform the friction brake components inspection, which is part of the daily inspection maintenance activity, for more information refer to Section 4.2. It is important to note that it is unusual to carry out daily friction brake component inspections for modern light rail vehicles, as the vehicle dynamic braking system provides most of the braking effort which means the friction brake equipment typically does not need to be inspected on such a frequent basis, for more information refer to Section 4.2.

## 3.6 MSF2

MSF 2 is the latest addition to the site. The facility provides more capacity for the additional Stage 2 vehicles, it provides an extra bay for light maintenance, and it also houses the wheel lathe and a bay for heavy maintenance, as well as an area for bogie retrofits and overhauls. MSF 2 consists of two stub ended tracks which do not have OCS (**Figure 3.52**). One of these tracks is over the wheel lathe, refer to Section 4.4.12 for more information regarding the wheel lathe and process to re-profile/true wheels. There is also a third LMB track with both mezzanine and pit access. There are two sets of moveable floor jacks in this building for lifting LRVs, and several bogie work stands for bogie maintenance and modifications (**Figure 3.53** and **Figure 3.54**).



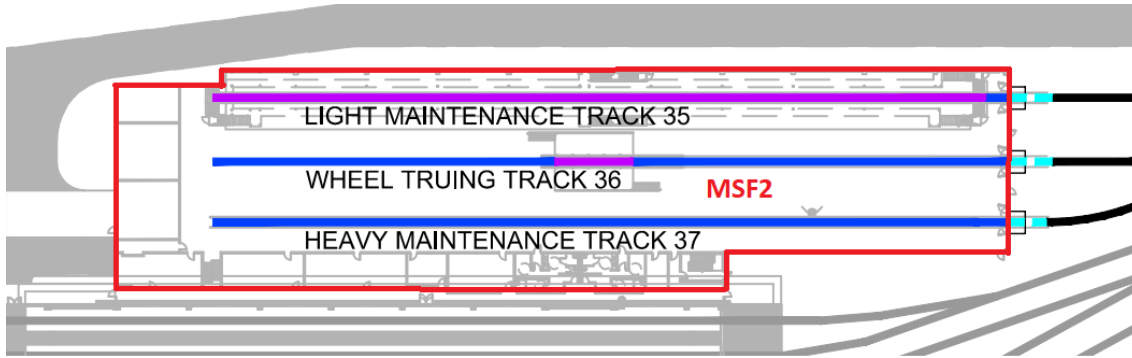


Figure 3.52: MSF2 Layout



Figure 3.53: Vehicle Lifted by Portable Jacks at MSF2

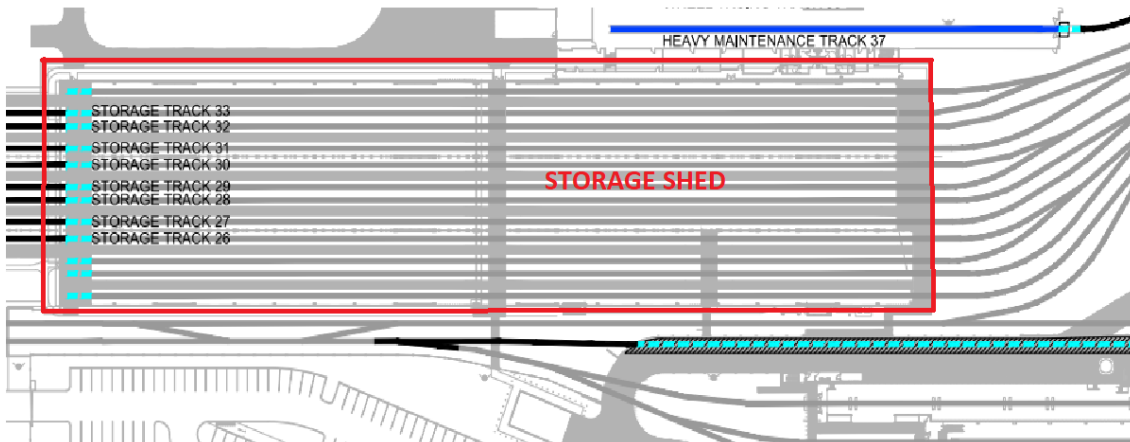


**Figure 3.54: Truck Work Area at MSF2**

### 3.7 Vehicle Storage Shed

- Daily inspection and cleaning
- Limited accessibility to inspect vehicles due to fence

The storage shed consists of 12 stub ended tracks (**Figure 3.55**). The initial vehicle storage building had capacity to hold four LRVs on each track. An extension was added to the vehicle storage shed extending eight of the tracks allowing them to store a maximum of six LRVs on each of the eight extended tracks.



**Figure 3.55: Storage Shed**

The stub ended LRV Storage Shed design only allows trains to exit from one end which limits operational flexibility if the leading train fails, as it blocks in the LRVs behind. The recent extension provides storage for up to six LRVs on each of the eight dead end tracks which means that a failed vehicle could prevent

three, two LRV train consists from entering service, the same can be said if there is a switch failure outside the shed.

In addition, the Storage Shed design is such that it offers little protection to both the vehicles and staff from the weather due to there being no doors on the ends of the building.

Further building design constraints include limited clearances between parked vehicles and internal building structures in the shed, which may create safety issues for staff accessing vehicles. The shed design does not follow Good Industry Practice, for example the German VDV standard for rail vehicle maintenance facilities states the following recommendations:

*The distances between the tracks are to be so selected that the driving staff has always got walking paths to all the vehicles. The following requirements are made for the walking paths:*

- *There has to be a minimum distance of 0.5m between fixed objects and the vehicle within the entire holding yard and the workshop on the passable areas.*
- *Walking paths between the vehicles that are freely passable have to be at least 1m broad (distance between tracks = biggest vehicle width plus 1m) or,*
- *if there are fixed installations (e.g. hall supports) on the walking path, there has to be a free access width of 0.85m on one side and a safety distance of 0.5m to the next vehicle on the other side of the support.*
- *If there is a walking path along a hall side wall, a minimum width of 0.85m is to be provided, too, and this width shall always be kept.*

*In areas in which people work (e.g. cleaning of vehicles, minor repair) the given minimum width of the walking paths does not suffice e.g., big mobile devices like sanding cars are to be operated on the paths.*

## 4 MSF Physical Inspection

Elements associated with track, OCS and vehicles have been investigated and it is noted that while some proposed changes, mitigations and corrective actions have been proposed or undertaken by Project Co, at this time, none of the issues can be considered to have been fully resolved.

### 4.1 MSF 1

MSF 1 was previously used by Alstom to assemble the first 46 vehicles of the project's Stage 1. It appears that many different parts not used on the assembly of these vehicles are still sitting next to the tracks, and the status or configuration control of these parts is unknown which could lead to incorrect/incomplete items being fitted to vehicles. Also, the stock left in the work areas leaves the shop looking disorganized and cluttered (**Figure 4.1**).

During our visit to the MSF, it was noted that there is a "bypass track" (bypass track 14) that passes between MSF 1 and the storage facility. It was reported to the Mott MacDonald team that this track is not commissioned and that the track is part of Stage 2 of the project. This appears to be an unnecessary constraint on the movement of vehicles inside the MSF yard. This bypass track appears as it could be used to facilitate the movement of vehicles in and out of the MSF at busy times such as when the fleet enters or returns from daily service.

Currently track 11 and the SIW track is utilized for morning launch. As the morning launch schedule is tight, up to five consists are staged on these tracks back through the yard curves. Any last-minute defects which occur during this process disrupt the launch wave. This also means that there are very limited options for moving a defective vehicle out of the way and into an LMB.

Similarly, the evening retrieval routes all consists through the SIW track for a partial daily inspection. Due to the rapidity of the retrieval waves, there is not enough time to perform a complete daily inspection in the SIW track. The elements of the daily inspection which require access to the trucks is performed on the SIW track, as this is not possible while the vehicle is in the storage shed.

Scheduling of each vehicle's weekly wash has to be monitored and coordinated. This adds another variable to each evening's retrieval waves, as consists arrive at a more rapid rate than can be processed through the wash track.

Through discussion with maintenance staff, there was an impression that the original intent for the SIW track and retrieval process was that all daily inspections were going to be performed as the vehicles were passed through the SIW track each evening. Once the daily inspection was completed, the vehicle could then proceed to the storage shed.

In practice, there is not enough time between each train consist retrieval to complete a full daily inspection. There are three waves of service reduction. The first is at 6pm, the next at 9pm, and the final wave at 1:30am. Each wave contains between three and five consists, varying with each wave. The number of vehicles in each wave will slightly increase as service returns to the original threshold of 15 vehicles. The daily inspection and cleaning process takes roughly three hours to complete, depending on the condition of the vehicle. This is expected to worsen once the service level returns to normal pre-COVID-19 requirements, and even more so when Stage 2 comes on-line.

The first morning launch wave starts at 4am, making the turn-around from evening service retrieval to morning launch a challenge, requiring significant coordination. As mentioned above, each vehicle needs to pass through the SIW track to perform part of the daily inspection. It then needs to be returned to the storage shed or be placed into a maintenance bay as required. This situation is complicated by having

very limited options for transiting vehicles from the SIW to either the LMBs or to the storage shed. Once the vehicles are in route to the storage shed, there is additional logistical coordination of the storage shed tracks being stub ended tracks. This requires additional attention to where each vehicle is parked to facilitate the morning launch, as well as any day-shift maintenance or maintenance moves.

The layout of the yard track determines that tracks 11 and 14 are required for nearly all moves from the storage shed to MSF 1, MSF 2, or the mainline. This means that any vehicle issues experienced while traversing these tracks creates significant disruption.

As mentioned above, the storage shed tracks are stub ended tracks. This means that there is only one way in and out of each track. The result of this is that a vehicle which is parked at the end of each track is difficult to extricate, especially if it is not able to move under its own power. As mentioned above, the logistics of which vehicles and consists are parked on which tracks is complicated by the factor of not having a loop or through tracks in the storage shed. Another factor in the storage logistic puzzle is some service routes have more or less mileage, which needs to be managed depending on the preventive maintenance schedule.

During the time of the Mott MacDonald team's visit to the MSF, it was noted that the movement of vehicles in and around the yard appeared to be time-consuming. In one case that was witnessed, a pair of vehicles which were considered "available" required an hour of time to be coupled together such that the vehicles would be in a service ready configuration. This period required for a relatively simple task is considered too long and given that the fleet size will be increased shortly, is of concern. This is compounded by the limited tangent track with no switches where vehicles can be stopped to allow coupling/uncoupling operations to take place. Noting that it is considered Good Industry Practice to not stop on switches when changing directions (e.g., reversing to uncouple) due the risk of derailling on switches, and potential damage to couplers on curved track due to them being outside their gathering/coupling range.

Another aspect adding to the challenges presented by the facilities and yard design is the operational requirement to obtain from yard control, authorization to go from one building to another one. For example, to go from MSF 1 to MSF 2, a hostler or any authorized personnel has to contact yard control to exit MSF 1 and request authorization to enter MSF 2. The same process applies to enter/exit the storage shed. It is understood that yard control authorization must be requested to enter the yard or to walk the tracks connecting to the main line. It is not clear why authorization is needed to go from one building to another one, understanding that to do so a hostler does not have to enter the yard or cross any tracks. Additionally, personnel at the facility indicated that there are not enough radios for each of the hostler, complicating even further personnel movement within the facility.



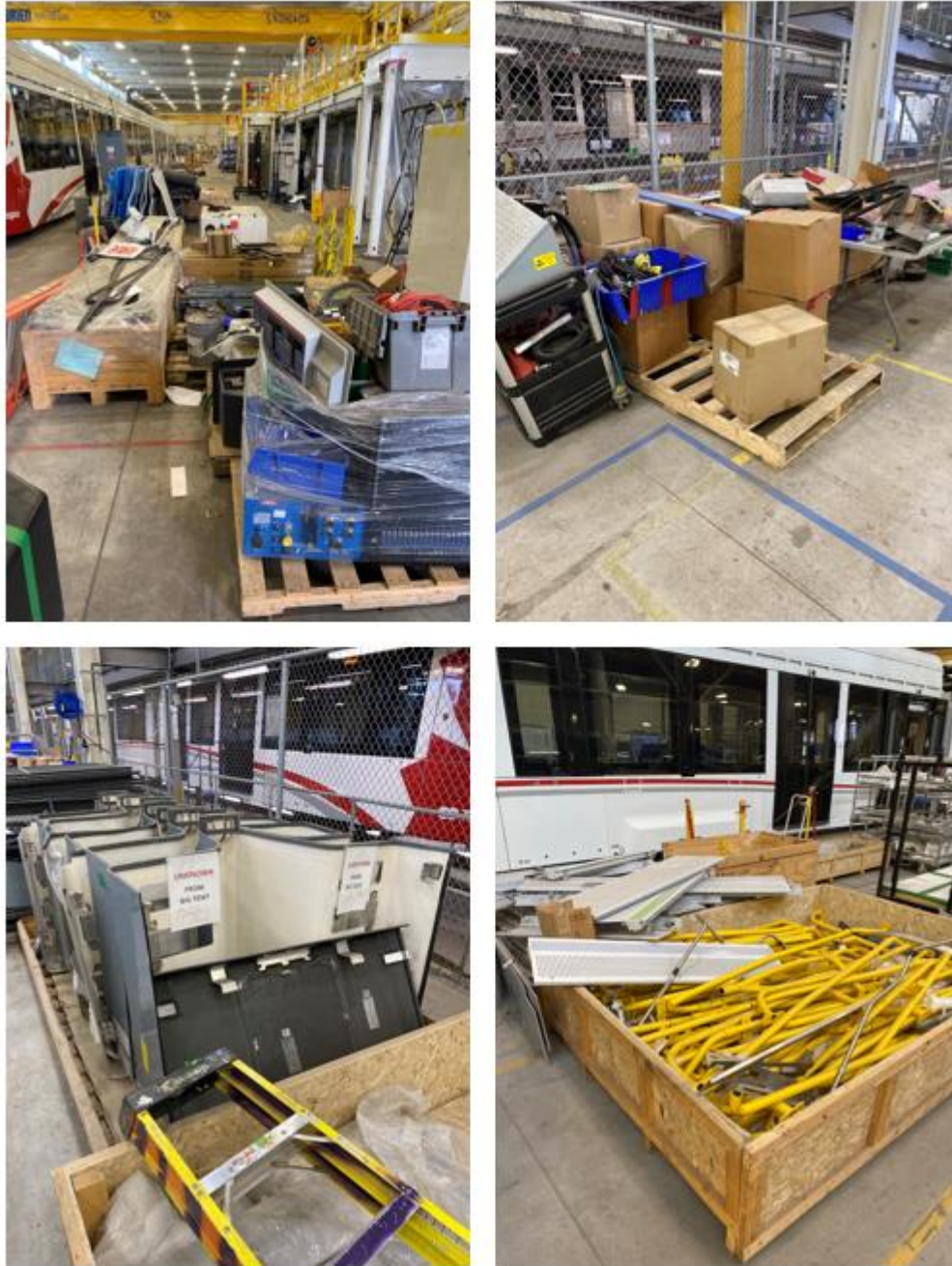
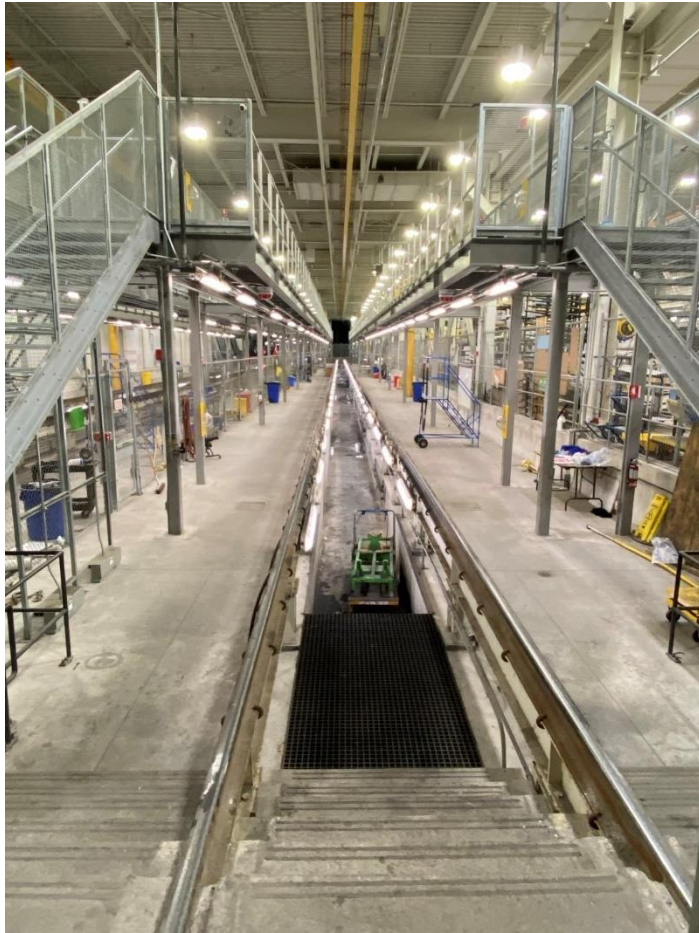


Figure 4.1: (a) (b) (c) (d): Parts Laying Out on the Floor Shop of MSF1 Next to Tracks 1 - 4



**Figure 4.2: View of LMB1 at MSF1**

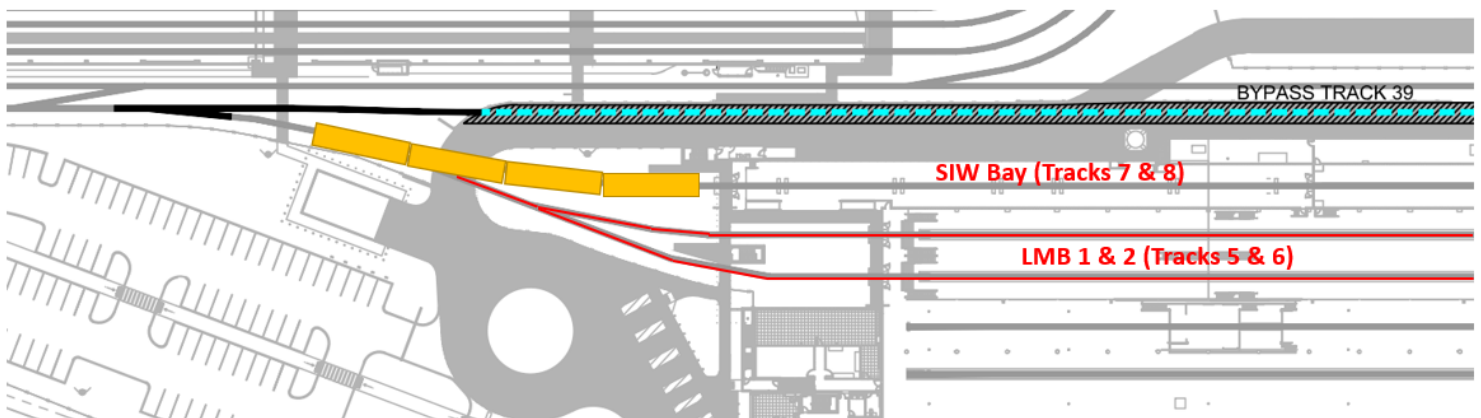
Both LMBs have OCS, access to the mezzanine is restricted to authorized personnel only (**Figure 4.3**).

LMBs 1 and 2 currently present two access issues. Access from the east side of the shop can be restricted by vehicles waiting outside the SIW Bays located on tracks 7 and 8 (**Figure 4.4**).





**Figure 4.3: Restricted Access to Mezzanine Area of LMB 1 and 2**



**Figure 4.4: MSF1 Access Issue to LMBs 1 and 2 When a Vehicle is Outside the SIW Bay**

The Mott MacDonald team was also informed that when vehicles try to enter LMBs 1 and 2 from the east side of MSF 1, the main fuse associated to LMBs 1 or 2 is blown and overhead power turns off. The maintenance team has adapted to this issue by not running vehicles from the east side of the yard into LMBs 1 and 2. This issue adds to the movement challenges presented by the design of the yard: vehicles in the storage shed or at MSF 2 that need to be moved to LMBs 1 or 2, have to be moved to the mainline connector track and entered into MSF 1 through the west side of the facility (**Figure 4.5**). It is possible that

there is not a smooth transition when the vehicle travels through the insulator separating MSF 1 from the yard (MSF 1 and the yard are powered through different supplies, the MSF 1 is grounded, and the yard is floated), causing a sudden rush of current, which causes the fuse to blow to protect the system.

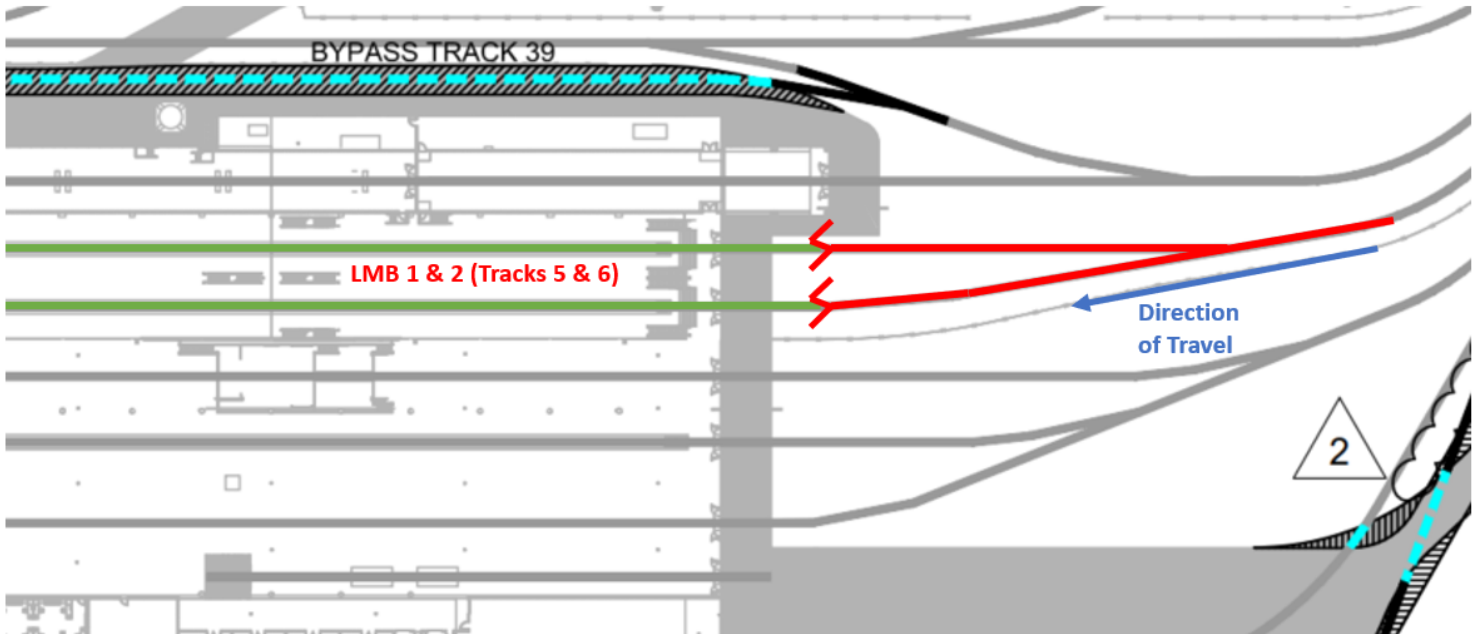
A temporary mitigation was proposed and implemented, by limiting train operation and bringing vehicles only through the west side of the Maintenance building, as communicated to the Mott MacDonald team. The underlying issue, or at least a very similar one, has previously been identified and a solution is proposed within the Rectification Plan (City Reference b)14), to replace the fused design with a new Stinger Panel, with the following options:

1. DC high speed circuit breakers
2. Fully rated load breaking DC Contactors

The proposed solution also called for:

- A Technical Working Committee to determine the best option (ALSTOM/Project Co/OLRTC)
- Design architecture drawing approval
- Full scale prototype and testing
- Certification and Sign-off Record of Engineer
- OEM manual/procedure revisions and training

A review of OCS and Trackwork drawings has shown that there are some minor discrepancies between the two packages, but nothing has been found which would be an obvious cause for the issue. According to the Rectification Plan, the proposed solution was to be implemented by early 2021. However, Mott MacDonald was informed by Project Co that this was an ongoing issue at the time of the site visits. Project Co need to provide evidence that the proposed rectification has taken place and the issue has been resolved, or a revised plan showing when the proposed solution will be implemented.

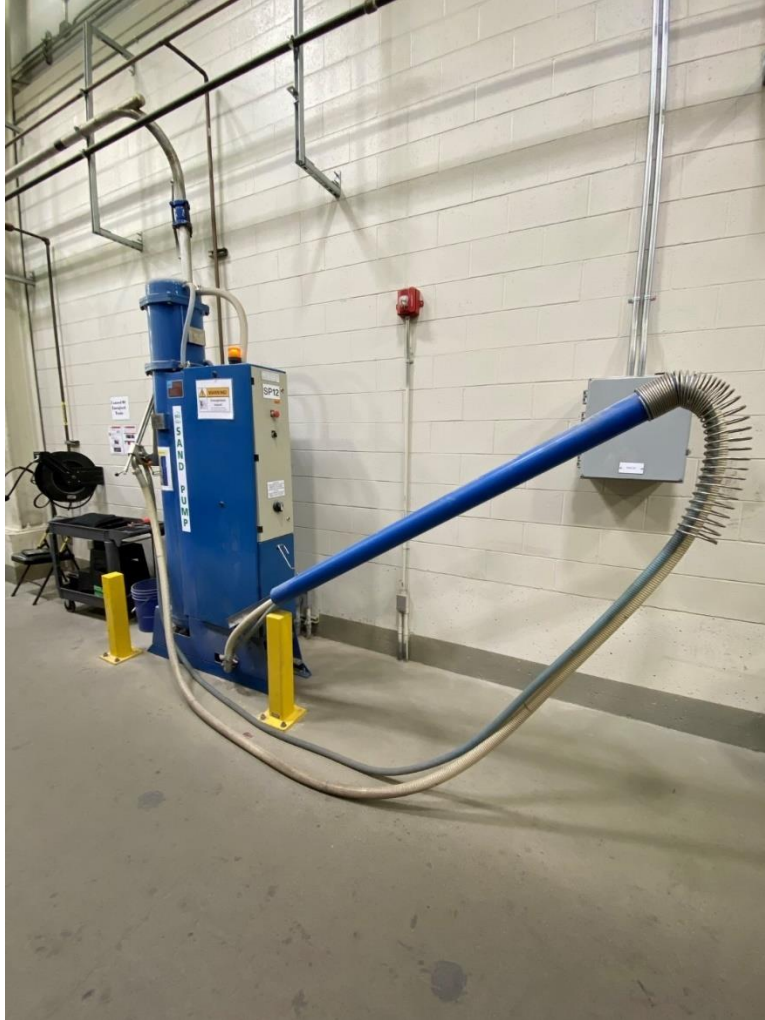


**Figure 4.5: MSF1 Access Issue to LMB 1 and 2 from East Side of Facility**

#### 4.2 Tracks 7 and 8

The sanding system and carwash system are located in tracks 7 and 8 respectively. On the SIW tracks the following activities are completed: filling of on-board sandboxes, filling of on-board wheel flange grease boxes, friction brake inspection, and car wash. It was reported by an Alstom employee that an inspection of friction brake components is performed as part of the daily inspection to meet the City of Ottawa's safety requirements, which is performed at the storage shed. Due to the storage shed limitations that prevent the opening of side skirts on both sides of the train, the inspection of the friction brake system is completed at the SIW track. At a later time when checking on the need for this task with the Project Co representative, it was suggested that the task was not in relation to meet a City safety requirement but a task the maintenance provider felt necessary. It is recommended to determine the reasoning behind the decision to inspect the friction brake system on a daily basis, as modern LRVs typically do not require a daily inspection check unless there is an underlying need.

On track # 7, 12 sanding pumps are located, six on each side of the vehicle (**Figure 4.6**). Due to the location of the sanding pumps, the device was fitted with longer hoses to be able to reach the sanding box ports on the vehicle. The extra length on the hoses causes sharp edges and substantial rubbing with the floor, causing the hoses to break. This issue is controlled by the use of sacrificial conduits. The Mott MacDonald team was informed that the system suffers from constant clogs due to presence of moisture in the sand.



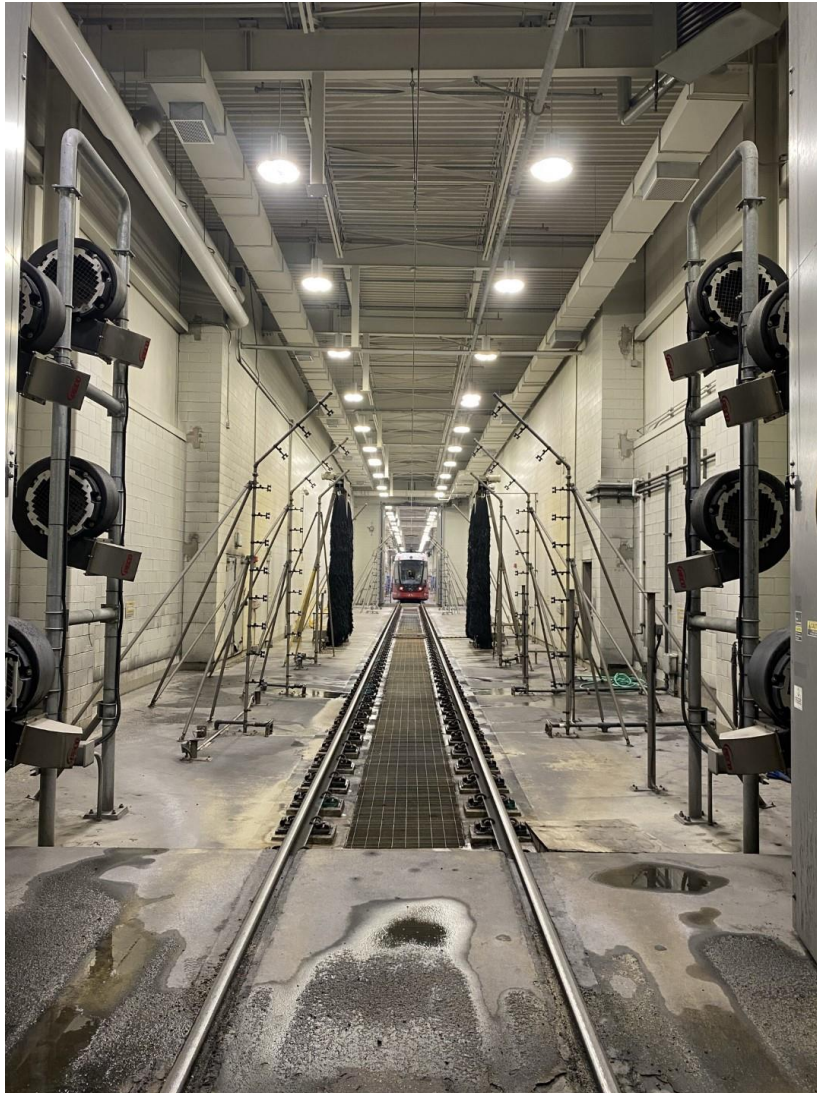
**Figure 4.6: Sanding Pump at Track #7**

It was noted that on track #7 there is a light fixture that indicates the status of the overhead catenary. Under normal conditions, when the catenary is energized, the red light should be “on,” and when the catenary is de-energized, the green light should be “on.” However, it was noticed that with the catenary energized, the green light was “on,” falsely indicating a de-energized catenary.

Although Project Co and Alstom personnel are aware of this situation, the issue has not been properly addressed. Instead, as a precaution measure, a temporary cover has been placed to cover the green indication light. This is a potential safety hazard for other personnel that may not be aware of the issue, e.g., subcontractors, and as such, an investigation and proper solution should be implemented as soon as possible. As of the time of this report, it is unknown if this issue has been resolved.

The carwash system is located on track #8 (**Figure 4.7**). The system can wash a consist of two vehicles without having to decouple the train, however, the system does not wash the front and rear cabs of the consist. Based on the Mott MacDonald team observations, the rinsing and blower systems’ performance are not optimal, leaving the vehicle wet and with detergent residue as it leaves the carwash track. This may also create problems during the winter when water on the bodysides and doors may freeze resulting in possible door seals sticking and creating door reliability issues.



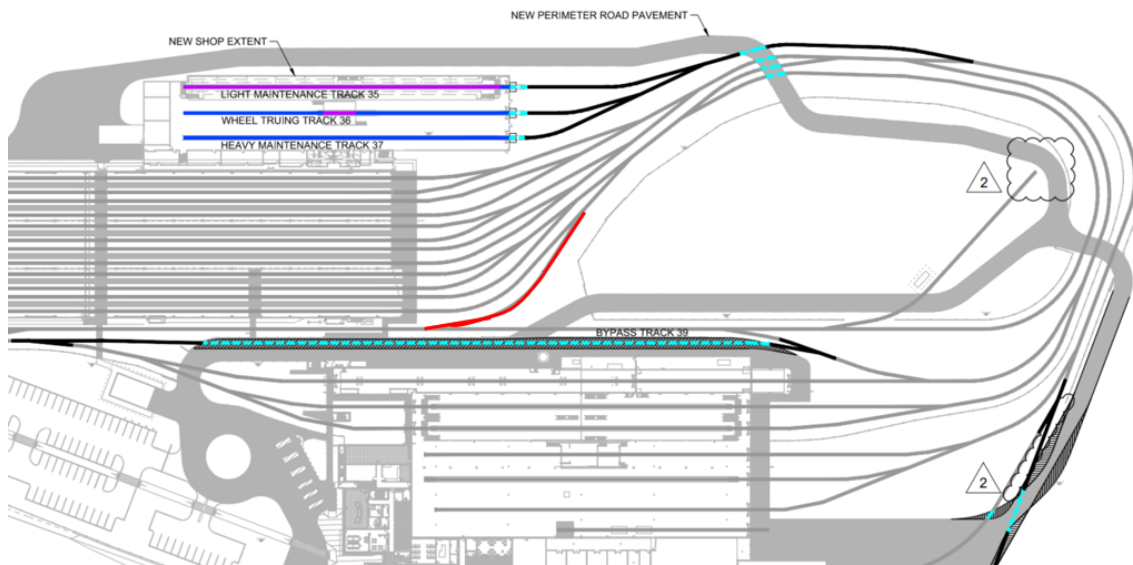


**Figure 4.7: Carwash System at MSF1**

Due to the facility and yard limitations, the SIW track is used to launch vehicles for revenue service in the morning hours. It is important to note that this track was not designed for this purpose and as such this practice is not recommended as staff are likely to be working/walking within this building while train movements are taking place.

Other tracks could be used for launching vehicles for revenue service including bypass track 39 and track 22 (**Figure 4.8**). The Mott MacDonald team was informed that bypass track 39 is not used and has not been commissioned as it is part of the project's Stage 2. This constraint adds further to the limited operational efficiency and flexibility of the MSF track layout.

In preparation for revenue service, vehicles are moved by hostlers from the yard or storage shed and are handed over to operators, either at the handover track or at the SIW bay. An important step in this process which is missing, when measured in context of Good Industry Practice, is giving the operator the opportunity to inspect the vehicle before departure ensuring it is in good condition and ready for service. This inspection should typically include activation of both cabins, and operation of communication system and passenger doors, among others. This inspection is currently not performed by operators before departure.



**Figure 4.8: Other Potential Vehicle Launch Tracks**

#### 4.2.1 Maintenance Supervisor Office within MSF1:

The Maintenance Supervisor office in MSF1 is within close vicinity of the working area, and the team found that there was no electronic yard board available to show vehicle locations. This is unusual for this type of situation and the office did have a large display panel mounted on the wall of the office, but this was not used to display the location of vehicles or their operational/maintenance status within the MSF sheds and yard.

#### 4.2.2 Vehicle Storage Shed

The design of the storage shed also presents challenges to perform preventative maintenance on the vehicle, most specifically daily inspections, and pre-departure inspections. Chain link fencing divides the storage shed at the centre of the building, which does not allow a reasonable working space to open the side skirts on one side of the vehicle. Due to the proximity of the dividing fences, the entirety of the daily inspection cannot be completed in the storage shed if the vehicle is parked on the centre 2 roads (**Figure 4.9** and **Figure 4.10**). In this situation, access to the vehicle exterior is limited to one side of each vehicle and is gained via paved walkways which creates not only a potential risk for the operator accessing the vehicle due to limited clearances but also a risk of the inspection missing a defect or potential safety check.



**Figure 4.9: Dividing Fence at Storage Shed and Limited Staff Access Between Tracks with No Walkway**





**Figure 4.10: Dividing Fence at Storage Shed with No Staff Access or Safety Clearance**

Additionally, if vehicles are parked next to another vehicle there is insufficient space for the vehicle side panels to be opened and for personnel to walk along the restricted access side of the vehicles, which is a safety concern (**Figure 4.11**).



**Figure 4.11: Limited Space Available Between Vehicles at the Storage Shed**

Another aspect that affects the movement of vehicles, especially during winter season, is the lack of doors at the storage shed (**Figure 4.12**) which is going to worsen the vehicle storage situation especially for those that are stopped long term due to missing parts and equipment especially for those that are open to the elements because of missing windows/panels. During winter conditions, snow can accumulate and enter the shed which makes the working area for staff both unpleasant and hazardous.





**Figure 4.12: Lack of Doors at Storage Shed**

The Mott MacDonald team inspected several vehicles stored at the storage shed that have been cannibalized for spares. These vehicles are: 1102 (old), 1108 (old), 1143, 1145, and 1146 (**Figure 4.13** to **Figure 4.15**). During meetings between the Mott MacDonald team and Alstom, Alstom indicated the removal of components have been properly managed and controlled and that they know exactly what components have been removed from each vehicle. However, a copy of the current parts list of items removed from each vehicle was not provided for review by the Mott MacDonald team. Without tight control of missing parts/equipment and/or a long-term storage strategy in place to prevent any further deterioration of the vehicles, it is likely that there will be negative long-term implications to the vehicles.

#### 4.2.3 Test Vehicles in Storage Shed

At the back, or west end, of the storage shed are several LRVs which are not complete. It must be noted that these were described as test vehicles, and so it is not expected that they were ever used in Revenue Service or to carry passengers. It is unclear whether missing parts were used to supplement missing equipment for in-service vehicles, and if so how configuration management has been exercised on the components removed.

The completeness varies depending on the vehicle. It is clear that some of these vehicles, 1154 and 1155 specifically, have recently arrived from Brampton and have yet to start the commissioning process, including outstanding snags and items previously identified at Brampton but have been left for the Ottawa team to address. This is considered undesirable as its likely to lead to any outstanding items to be missed, and extra burden being placed on the Ottawa team who are already overburdened with rectification and modification work on top of their routine maintenance requirements. Vehicles 1142 to 1146 are also stored here and exhibit varying degrees of completeness. 1142 appears to be complete, has decals, and had its power on. 1143 had no decals installed and is missing roof shrouds. Regular trucks are installed on the vehicle.

Mott MacDonald was informed that 1146 was the last vehicle to be built at Belfast Road before production was moved to Brampton. This vehicle does not have trucks installed and is missing exterior panels. The interior appears complete, but interior panels are open, which suggests that the interior equipment is either incomplete or has been partially removed. The interior and exterior bellows are not installed, with plywood covering the end portals. One of the cabs in the vehicle is missing the cab side windows, chip board panel covered by plastic are currently in place instead of cab windows.



**Figure 4.13: Vehicle Missing Side Panels, Coupler, Skirts and Roof Shrouds**

Vehicles 1135 and 1136, which are labelled as “1102 old” and “1108 old,” are the least complete vehicles. Neither have trucks installed. Both have incomplete exterior and interiors. At least one end of 1102 old does not have a coupler. 1108 old does not have a cab partition installed.



**Figure 4.14: Vehicle Missing Cab Components**

When asked about 1135 and 1136, Project Co indicated that these vehicles were used for qualification testing early in the project. When asked about returning them to a service ready state, we were told by Project Co staff in the MSF that there was the possibility that they would simply be replaced with new vehicles from Brampton as part of Stage 2. It is unclear how or why these vehicles were dis-assembled to this state after testing, or how configuration management has been exercised on the components removed. It is clear from the dust that these vehicles have not been moved for some time.





**Figure 4.15: Vehicle Missing Trucks**

On the floor of MSF1 are a number of pallets, and crates. Some of these are labelled “removed from TS 8.” While unconfirmed, it could be inferred that at least some of these interior panels, stanchions and interior panels may have come from 1108 old.





**Figure 4.16: Crates in MSF1 Labelled "REMOVED FROM TS 8"**

### 4.3 MSF Yard Area

#### 4.3.1 Signalling system and ATO still not operative in yard.

Currently the movements of the vehicles within the MSF facility are manually controlled and authored by the control room at the MSF. It is our understanding at this time that the ATO system is not functioning inside the MSF facility and is yet to be commissioned. Based on the number of current operational constraints and potential risks witnessed during the site visit it is difficult to visualise how the ATO system can be made to operate safely and reliably in its current form.

#### 4.3.2 Grease on top of rail

At numerous locations within the MSF facility, it was apparent that grease/lubrication is being applied to the gauge face of the rail by a manual means. At most locations where this activity has taken place there is evidence of excessive lubrication being applied and the lubrication being spread on the top of the rail head by the passage of the vehicle wheels. This situation is undesirable as interference with the rail/wheel interface will negatively affect the traction and braking efficiency of the vehicle.

According to Alstom, grease is applied manually only on the yard at curve C19. However, evidence of grease on top of the rail is evident at other locations, specially at the end of the East Connector, where vehicles stop before proceeding to enter the main line. Due to the gradient at this location (Approx. 4-5%), and the presence of grease on top of the rail, wheel spin/slide occurs causing the automatic sanding system to activate. The continuous wheel spin/slide occurrences due to lack of traction between wheel and rail caused by the presence of grease on the rail is the reason for the large amount of sand accumulated at this location, refer to **Figure 4.21** to **Figure 4.23**.



**Figure 4.17: Grease Contamination at East Connector**



**Figure 4.18: Grease on Top of Rail at East Connector**





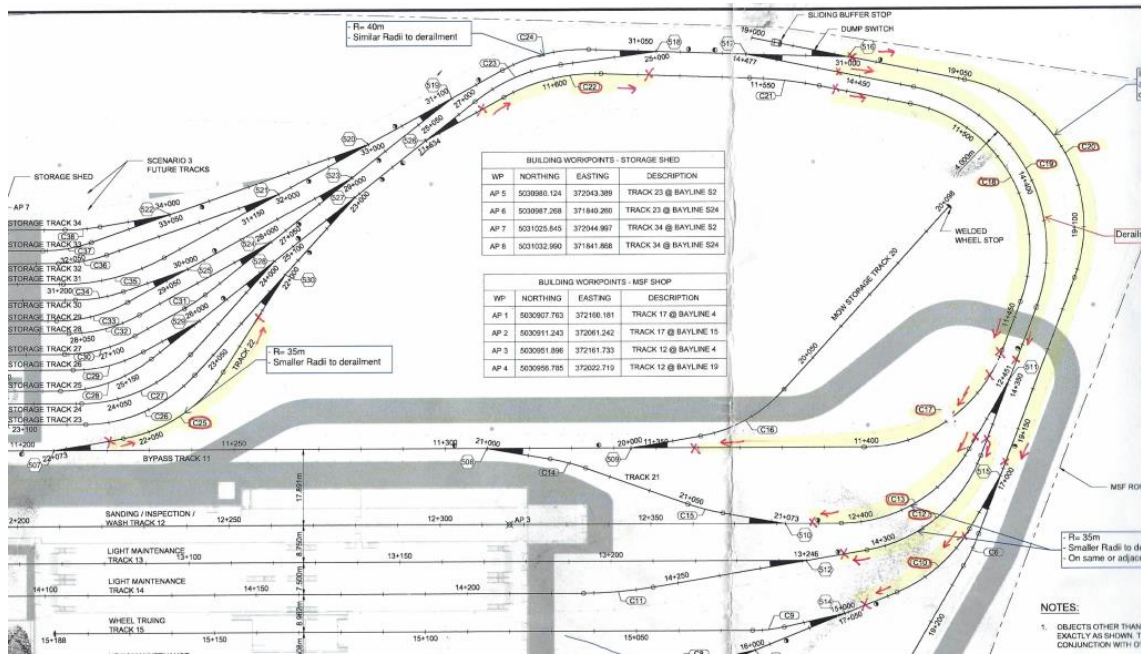
**Figure 4.19: Sand accumulated at East Connector Due to Excessive Wheel Spin/Slide Caused by Presence of Grease on Top of Rail**

#### 4.4 Track

The Mott MacDonald team responsible for reviewing track/infrastructure related issues carried out two site visits (July 21 and 22, 2021), to review general condition of track infrastructure and to carry out sample track measurements through selected curves. The focus was on curves with similar radii as curve 19 on track 14 where one of the derailments in 2020 took place (refer to Section 5.1).

##### 4.4.1 Sample Track Measurements

**Figure 4.20** shown below indicates the sections of track where the gauge has been measured, using a “Geismar model RTG-2” rolling track gauge. Measurements have been recorded manually in +/- 16th fractions from the standard gauge of 1435mm, e.g., a recorded +1/16 equals to approx. 1437mm. The main purpose of the gauge measurements was to determine whether there is a general trend toward tight gauge through the curves (below 1435mm) or gauge widening.



**Figure 4.20: Sample Track Measurements**

Throughout several curves, kinks in the rail at weld locations have been observed. At some of those locations the gauge is as tight as 1430mm or as wide as 1443mm.

Confirmation has been provided by the City that at initial construction, the pre-bent rails were cut such that only fully pre-bent sections of rails were welded together. Since initial installation, the rails through C19 have been transposed with each other, and thus were cut and re-welded, potentially resulting in the kinks observed if not aligned properly prior to welding. The cause of the kinks at the other curves however remains unknown.

It is important to note that tight to gauge track on the small radius curves could lead to potential wheel flange climb resulting in derailment. The severe kinks in the rails will also prevent a smooth transition of the wheels on the outer rail and when combined with the tight track gauge may also contribute to potential derailment risks.





**Figure 4.21: Kinks at Weld Location (C19), Including Grease Contamination of the Top of Rail**

#### 4.4.2 Curves C10, 12 and 13

The gauge through curves C10, C12 and C13 is generally less than 1435mm. At some weld locations, the gauge is as tight as 1430mm.

#### 4.4.3 Curve C17

The gauge through curve C17 is very inconsistent, gauge widening has been observed but also tight gauge down to 1430mm (at weld on inner rail).

#### 4.4.4 Curves C18, 19 and 20

Rails through C19 have been transposed with each other (swapped). Plastic spacers between the shoulder and the rail have been replaced to widen the gauge, however gauge widening is inconsistent with significant kinks at welds. The gauge varies between 1435mm (at welds on inner rail) to 1443mm (C19), the gauge through C18 and C20 is more consistent.

#### 4.4.5 Curves C22 and 25

The gauge through curves C22 and C25 is generally less than 1435mm. At one location on curve C22, the gauge is as tight as 1429mm.

#### 4.4.6 Eastbound Connector

The gauge through the E/B Connector curve varies between 1433mm and 1438mm, at some locations the gauge drops to 1432mm and increases to 1440mm at other locations. The gap between the restraining rail and the running rail varies between 45-55mm.

#### 4.4.7 Westbound Connector

The gauge through the W/B Connector curve varies between 1432mm and 1437mm, at some locations the gauge increases to 1438mm. The gap between the restraining rail and the running rail varies between 40-50mm.

#### 4.4.8 Track Condition Review

##### Track Geometry

In addition to issues associated with the track gauge as listed in Section 4.4.1 above, general issues with the track geometry were found, most notably at the transition between ballast track and DFF track at the E/B and W/B Connector tracks (**Figure 4.26** and **Figure 4.27**).



**Figure 4.22: EB Connector, Track Geometry at Interface Between Ballast Track and DFF Track**





**Figure 4.23: WB Connector, Track Geometry at Interface Between Ballast Track and DFF Track**

On both tracks the rails appear to straighten out towards the end of the slab with a sudden kink in the adjacent ballast section. The most likely cause for this misalignment is the significantly different lateral restraint provided by the direct fixation fasteners on the track slab compared to the ballast section. Stress in the rail would peak at the transition, resulting in a lateral movement in the ballast track.

Figure 4.24 also shows the irregular wheel/rail wear pattern that has formed on the top of rails caused by a poor transition of the rails at the point between the slab and ballasted track, which is likely to result in a severe jolt of the trucks and vehicle car body as it attempts to correct its steering through the curve.

#### 4.4.9 Rail Wear

Through small radii curves, side wear on the rail heads is visible both on the inner and the outer rail, due to the tight curve. The gauge measured (see above) is including the side wear, indicating that the initial as-built gauge was even tighter.

The purpose of the restraining rail installed through the E/B and W/B connector tracks is to prevent a wheelset which already started climbing up on the outer rail from moving laterally such that it derails. Under normal operational conditions, the back of flange of the inner wheel should not be in contact with the restraining rail. The vertical surface of the restraining rail was found to have a shiny surface, indicating contact between the back of flange and the restraining rail. This would further indicate that – provided that the restraining rail is installed at the correct distance from the running rail – the outer wheels of passing trains are actually starting to climb up on the outer rail.

It is important to note that Alstom are proposing to implement a fleet wide modification (reference: Design IPONAM T20) to the bogie axle beam assemblies, the aim being to reduce the misalignment between the wheel hub splines and the drive shaft spline during both loaded and unloaded vehicle operating conditions. This modification is to address the initial V5 design wheel camber misalignment which according to Alstom has an impact on the wheel back-to-back dimension. At this stage, without further analysis, it is unknown if the current camber angle and back-to-back dimension has any influence on the current wheel/rail interface in respect to the narrow track gauge issues and potential wheel flange climb and derailment issues previously discussed in Section 3.4 above. It is understood from the City that the

IPONAM T20 modification is currently on hold until the root cause of the mainline derailment in August is fully understood.

#### 4.4.10 Other

As previously discussed, throughout the yard tracks and connector tracks significant deposits of lubricant, partly mixed with metal shavings, are present on the rails. Apart from one wayside lubricator at curve 19 (track 14), we understand that lubricant is being applied manually to the rail gauge corner throughout other curves.

Large amounts of sand are deposited along the E/B connector track before it joins the mainline track. At this location, there is a significant longitudinal gradient, and it is assumed that the excessive use of lubricants (see above) causes the wheels to slip/slide, hence the (excessive) use of sand.

#### 4.4.11 Summary of Other Findings

Mott MacDonald has further identified the following as key revenue vehicle issues to be addressed in future work:

- Abnormal pantograph carbon wear
- Line inductor roof flashovers
- Auxiliary converter, line contactor, HSCB failures
- High number of wheel flats
- Passenger door failures
- Cracked wheels
- Wheel/rail noise

In this regard, we have not received an update from Project Co regarding if rectification activities for the LRV fleet are on schedule. The following subsections summarize the recommendations suggested to Project Co/Alstom and concerns to date.

##### 4.4.11.1 Abnormal Pantograph Carbon Wear

Abnormal pantograph carbon wear was one of the items identified at the initial MSF site visit in September 2020.

Alstom has indicated via previous correspondence that OCS wire stagger has been addressed, which should in turn reduce the amount of abnormal pantograph carbon wear.

As part of the latest MSF tour, a complete pantograph unit was found to be located on a pallet on the shop floor. The pantograph carbon has two significant wear grooves which appear to mirror each other. There was also some evidence of the OCS contact wire running onto the pantograph head horns. This evidence would indicate that there is still an issue with the pantograph and OCS interface.



**Figure 4.24: Grooved Wear on Pantograph**

The amount of grooved wear on this example (**Figure 4.24**) does not appear to have improved from what was observed in September of 2020, but it is still noteworthy. A correctly adjusted OCS stagger should provide a more even wear pattern, with no distinct grooves.

The grooving in the pantograph carbon, combined with the wear on the pantograph head horns, raises the concern that the OCS wire is being kept in the groove until enough force is applied, resulting in the OCS wire “bouncing” out of the groove. This “bounce” compounds the wear in the groove and introduces undue strain on the OCS system as a whole. This could also be compounded by the pantograph raising pressure being incorrectly adjusted as we have previously raised concerns about the process for adjusting the pantograph pressure.

#### 4.4.12 Wheel Truing

The initial conclusions from reviewing the relevant wheel truing information, related on-site observations, and the Major Issues Plan actions for the ongoing wheel flat issues have raised several concerns for Mott MacDonald, as they have the potential to impact on the braking integrity of the vehicle design. These concerns include some of the following:



- The Major Issues Plan proposal to reduce the braking rates needs very careful consideration, as this should be the very last resort and only after all areas have been exhausted. Changes to the braking rates may require longer stopping distances, which could affect the LRV's ability to meet the current timetable. We are unable to determine the status of this modification proposal, but as a minimum, a detailed risk assessment with supporting information is needed to demonstrate that new issues/risks are not being introduced.
- A further potential issue is whether the vehicles are achieving the emergency deceleration rates/stopping distances required when wheels are skidding. If this is the case, Project Co may wish to consider speed limitations in cold weather in case of a real emergency until the system can be proven to be reliable.
- The original sand being used for the sanding system is the wrong grade/type; while an alternative sand has been identified and subsequently supplied, there is nothing to demonstrate that it meets the OEM requirements for the onboard sanding equipment by ensuring it does not block the pipework/sanding ejector assembly and works effectively during wet and extreme weather conditions.
- Mott MacDonald understand that vehicles have entered into service with no sand and/or defective sanding systems; a post site visit review of the vehicle pre-service departure checks and testing process identified several areas that could improve this process, including restructuring the process and requirements to make it more efficient and clearer to the operator.
- The site visit also identified that there are maintenance issues with the current on-board flange lubrication system, these include incorrect alignment of the lubricant spray nozzles, and in one case, one of the nozzle assemblies was missing. These could result in lubricant being sprayed onto the wheel tread rather than the wheel flange, leading to potential wheel to rail adhesion levels being compromised, and possible wheel flats.
- Grease contamination on the rail crown surface – the site visit has further confirmed Mott MacDonald's initial observations that the processes used to apply lubrication to the gauge face of the rails as a mitigation to prevent potential wheel flange climb and derailment is likely to be cause wheel/rail adhesion problems. The high level of grease being applied both manually and by the track mounted application system in the MSF yard is leading to the wheel flanges squeezing the already applied grease onto the rail crown surface. The wheels then spread the grease across the surface each time they pass over these locations, which in turn coats the surface of the wheel treads with lubricant resulting in grease carryover around the system, including at the connector tracks with the mainline. The application of grease in the quantity seen applied could well be contributing to the high number of reported wheel slip/slide events, subsequent wheel flats, and possible vehicle/signaling system overshooting events due to poor rail adhesion conditions from the lubricant being spread across the system by the wheels.

- 10) Wheel Truing – Alstom is investigating the coarseness of the wheels after they have been machined. Alstom undertakes detailed measurements both before and after each set of wheels is machined.
- 11) Wheel Wear Recording – Alstom regularly checks the wheel wear and records its findings.
- 12) Wheel Flange Lubrication – Alstom inspects and adjusts lubrication nozzles every 150,000km. They are also checked every 30,000km when the wheels are trued.
- 13) Sanding System – Alstom tests the onboard sanding system everyday as part of the daily inspection. The quantity of sand onboard is also checked. The type of and used was changed recently as a result of the wheel flat task force

**Figure 4.25: Excerpt from RTG-OTT-00-0-LET-1035 - Independent Expert Review - Update and Next Steps**

The excerpt above from Project Co 's document RTG-OTT-00-0-LET-1035 - Independent Expert Review - Update and Next Steps (**Figure 4.25**), includes Project Co's initial responses to concerns regarding wheel flats and wheel maintenance presented above. However, following our request for the relevant

maintenance information and associated wheel data there remains no data evidence to support the statement below from Alstom. Mott MacDonald have provided an initial response to the four items listed by Alstom:

- 10) Wheel Truing – while Alstom states they are investigating the coarseness of the wheels after they have been machined, the findings should be expected to describe what method has been used to date in order to determine what is classed as a pass/fail criteria when checking the coarseness of the wheels, and what mitigation measure will be put in place to ensure this process will be effective.
- 11) Wheel Wear Recording – expected to describe how wheel wear is measured, including the type of measuring device and its calibration, and recorded.
- 12) Wheel Flange Lubrication –expected to see the procedure used by the maintenance team to instruct them on the inspection criteria and adjustment settings for the lubrication nozzles for both routine maintenance inspections and post wheel truing/wheel replacement, as any change in wheel diameter will increase/decrease the clearance/position of the nozzles in relation to their position with the wheel flange.
- 13) Sanding System – as part of the decision process to change to the new sand type, documented evidence would be expected to demonstrate the sand type meets the OEM requirements for the on-board sanding equipment, as a minimum.

In order to provide supporting data and demonstrate that corrective actions have been put in place are having the desired effect, it is recommended that Alstom be requested to submit sample measurements, new/worn tolerance values and inspection records for wheel truing, wheel wear recording, and flange lubrication as well as type/qualification tests for the new sand.

#### 4.4.12.1 Wheel Truing Process

During the course of the Mott MacDonald site visit, a wheel truing was witnessed and provided information on the process and procedures that are used for this process. A team of two technicians are used when wheel truing is undertaken. This team also moves the vehicle onto the wheel lathe and along the bay as each wheelset is completed in turn. The team is also responsible for the removal and re-installation and adjustment of the sanding nozzles and wheel flange lubricators that have been removed/disconnected to allow the required clearance for the wheel truing operation.

The wheel lathe (**Figure 4.26**) used is a Hegenscheidt U2000-150D Underfloor Wheel Lathe supplied by the NSH USA Corporation ([Hegenscheidt U2000-150 Underfloor Wheel Lathe | NSH USA Corporation \(nsh-usa.com\)](http://Hegenscheidt U2000-150 Underfloor Wheel Lathe | NSH USA Corporation (nsh-usa.com))). This machine is capable of tandem machining of two wheel sets simultaneously but was at the time only using one machine head and therefore one wheel set at a time was being machined which is not an efficient method of operation. The machine is also a CNC lathe with automatic positioning, machining and measuring processes available to the operators. Unfortunately, not all of the automatic functions of the machine were being used with the machining process being manually set up and controlled by a member of the team. The automatic measuring of the wheel set was used both before and after the wheel set was machined.

On reviewing the process of wheel turning in a discussion with the two operators on the day, the non-use of the machine's automated cutting process was questioned. The operators suggested that the machine's cutting depth setting was too great and that the wheel diameter would not meet the required tolerances if the automatic process was followed. The operators expressed that in their experience allowing the machine to automatically take its calculated cut depth would then require intervention by them at the completion of the machines wheel truing to return the wheel diameter to within allowable tolerances. This was an additional step that could be avoided if the cut was less and controlled by the operator.

The operator also mentioned that additional wheel lathe operators had recently been trained on the machine so there were now a larger number of personal that would be able to work on the fleet's wheel truing program.

It is considered unusual to have a large number of the maintenance team trained and using the wheel lathe in an MSF. Most facilities have a small, dedicated number (depending on the demand for the work) of their technicians trained and able to operate the wheel lathe as this creates higher levels of skill in the lathe operator as their experience with the machine grows. Having a dedicated team of technicians that operate the wheel lathe provides for high levels of skill within this group as they have a higher frequency of interaction with the machine and its controls, workings and results.



**Figure 4.26: Hegenscheidt U2000-150D Underfloor Wheel Lathe**

#### 4.4.13 Wheel Lathe Calibration

It is good practice in the process of machining wheel sets and the truing of wheel sets to ensure that the machine used for this function is correctly maintained and calibrated. At the time of the Mott MacDonald team's visit to the Belfast road MSF facility, there was no indication that a means of calibration was available for the wheel lathe (e.g., it is typical for a calibrated wheel set to be provided).

#### 4.4.14 Wheel Flange Lubrication

Mott MacDonald believes that the setting and location of the spray nozzle outlet for the Wheel Flange Lubrication System are important to ensure correct location of the oil being ejected. Without a defined adjustment setting the oil can be applied incorrectly onto the tread of the wheel which will compromise the friction of the wheel tread on the rail.

Alstom's document, *100,000 KM – Sanding and Greasing Preventive Maintenance Procedure* document reference *OTT-LRV-MTN10-WMS=030- Revision A* (dated October 28, 2019) identifies the need to check



the gap (page 7 of 17, item h.) between the spray nozzle and the outer diameter of the wheel, however this procedure fails to identify the location of the spray nozzle. The procedure refers to the location of the systems mounting block and its distance from the wheel not the spray nozzle. As shown in the image below (**Figure 4.27**), the alignment and volume of oil delivered by this system can easily apply an amount of oil that leads to the wheel tread having oil in an undesirable area leading to wheel slide situations arising.



**Figure 4.27: Wheel Flange Lubrication Location**

It is recommended that Alstom review the procedure and the maintenance instructions related to the setting of the flange lubrication equipment following wheel truing and wheel replacement in order to ensure the alignment is related to the relevant wheel diameter and flange position. This may also require a formal re-training of staff to ensure they are aware of the process necessary to ensure the alignment is correct and made aware of the implications of incorrectly setting the flange lubricator spray nozzles.

#### 4.4.15 Work Order Process and Visibility

##### 4.4.15.1 Work Orders in the Maintenance System

The maintenance contractor to Project Co, Alstom, uses a computer-based system called GSI to open, track and close work orders. The City and Project Co have the ability to view these work orders through a system called Agility with an acronym of IMRS. There is a level of detail contained within the work orders that is not available for the parties that are viewing the work order from Agility. Having the ability to see all the details of the work orders is considered Good Industry Practice and creates much easier understanding for all parties when full and consistent information is available to all. This lack of WO detail has been an area that causes concern for those that are involved reviewing vehicle longer term condition and the history of work performed on the vehicles. This lack of visibility requires the groups (Project Co and the City) that are tracking and maintaining an understanding of their assets to often request information from the maintenance provider. This in turn can cause a delay in the information flow and therefore effect decisions on the best course of action following incidents and faults on the vehicles.

The work order system currently in place was not meant to provide this higher level of detail to the parties downstream of the maintenance activity. It has led to a situation where information is not freely available to all parties that are concerned with the vehicle's history of events and repairs. If the three parties are to continue in their efforts to all be investigating and reviewing the vehicle history, the situation would be greatly improved if they all had access to the same data.

##### 4.4.15.2 Work Order Governance

During the Mott MacDonald team's visit there was discussion regarding a WO showing as "closed" on the Agility system and closed with the comment "to be observed." This is considered not a correct reason for the WO to be closed but in fact the WO should have remained "open," with the same comment. Until such time as the work is considered completed by the maintenance provider, the WO should have remained open. As an example of the need for further information on this WO, they may have been other information which was not visible to Project Co or City staff that could have led to a better understanding of the WO and the reason for it being closed.

There also appears to be issues around long outstanding "open" work orders recorded against vehicles that were in service. As the WO system is the primary source of recording tasks and events on vehicle assets and under the control of Project Co's maintenance provider, it is reliant on the same party to ensure that the vehicle history is kept up to date. At the time of the Mott MacDonald team's visit, vehicles 1104 and 1139 were both under maintenance in the facility. Examples of these vehicles outstanding WOs are listed below.

| Work Order | Asset    | Description | Site | Location | Sublocation | Job                                      | Type       | Status    | Priority | Start            | Due              |
|------------|----------|-------------|------|----------|-------------|--|------------|-----------|----------|------------------|------------------|
| 103766     | LRV-1139 | TRAIN 113   | LRV  | LRV-1139 |             | RS 1139, side skirt rod missing          | Unplanned  | Responder | Alstom_C | 7/10/2021 0:21   | 7/17/2021 0:21   |
| 101561     | LRV-1139 | TRAIN 113   | LRV  | LRV-1139 |             | RS1139 roof fairing rubber guards        | Unplanned  | Responder | Alstom_C | 6/26/2021 17:36  | 7/3/2021 17:36   |
| 101560     | LRV-1139 | TRAIN 113   | LRV  | LRV-1139 |             | RS 1139 Longitudinal damper paint damage | Unplanned  | Responder | Alstom_C | 6/26/2021 16:46  | 7/3/2021 16:46   |
| 101559     | LRV-1139 | TRAIN 113   | LRV  | LRV-1139 |             | RS 1139 Transversal dampers leakage      | Unplanned  | Assigned  | Alstom_C | 6/26/2021 16:30  | 7/3/2021 16:30   |
| 101544     | LRV-1139 | CAR C (IM)  | LRV  | LRV-1139 | LRV-1139    | RS 1139-C Earth Current Return Cable     | Unplanned  | Responder | Alstom_C | 6/26/2021 13:10  | 7/3/2021 13:10   |
| 89164      | LRV-1139 | CAR A (MC)  | LRV  | LRV-1139 | LRV-1139    | RS 1139-A SAND BRACKET REPLACEMENT       | Unplanned  | Responder | Alstom_C | 4/12/2021 16:00  | 4/19/2021 16:00  |
| 89149      | LRV-1139 | TRAIN 113   | LRV  | LRV-1139 |             | RS 11339 - C LHS bogie 4                 | Unplanned  | Responder | Alstom_C | 4/12/2021 10:33  | 4/19/2021 10:33  |
| 89148      | LRV-1139 | TRAIN 113   | LRV  | LRV-1139 |             | RS 1139 - C bogie 3 RHS                  | Unplanned  | Responder | Alstom_C | 4/12/2021 10:27  | 4/19/2021 10:27  |
| 75046      | LRV-1139 | TRAIN 113   | LRV  | LRV-1139 |             | RS 1139 - A sanding nozzle heater cable  | Unplanned  | Assigned  | Alstom_C | 1/20/2021 19:13  | 1/27/2021 19:13  |
| 62749      | LRV-1139 | CAR B (MC)  | LRV  | LRV-1139 | LRV-1139    | IOS Code on LRV39. IOS036                | Service Re | Assigned  | SF Med 0 | 11/9/2020 15:01  | 11/10/2020 15:01 |
| 61422      | LRV-1139 | TRAIN 113   | LRV  | LRV-1139 |             | Rs 1139 roof fairing                     | Unplanned  | Responder | Alstom_C | 10/31/2020 10:12 | 11/7/2020 10:12  |

| Work Order | Asset    | Description | Site | Location | Sublocation | Job                                       | Type      | Status    | Priority | Start           | Due             |
|------------|----------|-------------|------|----------|-------------|---|-----------|-----------|----------|-----------------|-----------------|
| 107620     | LRV-1104 | TRAIN 110   | LRV  | LRV-1104 |             | RS 1104-A,C,B Earth current cable         | Unplanned | Assigned  | Alstom_C | 8/2/2021 11:18  | 8/9/2021 11:18  |
| 107519     | LRV-1104 | TRAIN 110   | LRV  | LRV-1104 |             | RS-1104 ADB transversal dampers           | Unplanned | Responder | Alstom_C | 8/2/2021 5:09   | 8/9/2021 5:09   |
| 107516     | LRV-1104 | TRAIN 110   | LRV  | LRV-1104 |             | RS-1104A Cab heater panel                 | Unplanned | Responder | Alstom_C | 8/2/2021 4:00   | 8/9/2021 4:00   |
| 107390     | LRV-1104 | CAR A (MC)  | LRV  | LRV-1104 | LRV-1104    | RS 1104-A Heat shrink on earth current    | Unplanned | Assigned  | Alstom_C | 8/1/2021 12:46  | 8/8/2021 12:46  |
| 107388     | LRV-1104 | TRAIN 110   | LRV  | LRV-1104 |             | RS 1104 cab heater missing relay          | Unplanned | Open      | Alstom_C | 8/1/2021 12:41  | 8/8/2021 12:41  |
| 107387     | LRV-1104 | CAR C (IM)  | LRV  | LRV-1104 | LRV-1104    | RS 1104-C Axle 6 LHS spline greasing      | Unplanned | Responder | Alstom_C | 8/1/2021 12:28  | 8/8/2021 12:28  |
| 107382     | LRV-1104 | TRAIN 110   | LRV  | LRV-1104 |             | RS 1104 -A B sunblinds                    | Unplanned | Assigned  | Alstom_C | 8/1/2021 11:59  | 8/8/2021 11:59  |
| 107379     | LRV-1104 | TRAIN 110   | LRV  | LRV-1104 |             | RS 1104-A B footrest stripped bolts       | Unplanned | Responder | Alstom_C | 8/1/2021 9:41   | 8/8/2021 9:41   |
| 107200     | LRV-1104 | CAR D (CC)  | LRV  | LRV-1104 | LRV-1104    | RS 1104-D roof fairing stripped bolt      | Unplanned | Assigned  | Alstom_C | 7/31/2021 11:01 | 8/7/2021 11:01  |
| 107080     | LRV-1104 | TRAIN 110   | LRV  | LRV-1104 |             | RS 1104 C - HAVC                          | Unplanned | Responder | Alstom_C | 7/30/2021 21:01 | 8/6/2021 21:01  |
| 107006     | LRV-1104 | TRAIN 110   | LRV  | LRV-1104 |             | RS 1104 Greasing & sanding Pressure       | Unplanned | Responder | Alstom_C | 7/30/2021 5:33  | 8/6/2021 5:33   |
| 106848     | LRV-1104 | TRAIN 110   | LRV  | LRV-1104 |             | RS 1104-B Missing Hardware Bogie Bracket  | Unplanned | Responder | Alstom_C | 7/29/2021 12:01 | 8/5/2021 12:01  |
| 106690     | LRV-1104 | TRAIN 110   | LRV  | LRV-1104 |             | RS1104 - APS2 replacement                 | Unplanned | Responder | Alstom_C | 7/28/2021 11:51 | 8/4/2021 11:51  |
| 105183     | LRV-1104 | TRAIN 110   | LRV  | LRV-1104 |             | RS1104 - B Internal display unit cover    | Unplanned | Responder | Alstom_C | 7/19/2021 1:58  | 7/26/2021 1:58  |
| 105005     | LRV-1104 | TRAIN 110   | LRV  | LRV-1104 |             | RS1104-A phone hand receiver damaged      | Unplanned | Assigned  | Alstom_C | 7/17/2021 23:02 | 7/24/2021 23:02 |
| 103768     | LRV-1104 | TRAIN 110   | LRV  | LRV-1104 |             | RS 1104BCD 4 side skirt rods missing      | Unplanned | Responder | Alstom_C | 7/10/2021 0:26  | 7/17/2021 0:26  |
| 100828     | LRV-1104 | TRAIN 110   | LRV  | LRV-1104 |             | RS LRV1104 REPLACING STICKER              | Unplanned | Open      | Alstom_C | 6/22/2021 13:14 | 6/29/2021 13:14 |
| 100592     | LRV-1104 | TRAIN 110   | LRV  | LRV-1104 |             | RS 1104 - MC2 Booster Relay               | Unplanned | Open      | Alstom_C | 6/21/2021 2:25  | 6/28/2021 2:25  |
| 97392      | LRV-1104 | TRAIN 110   | LRV  | LRV-1104 |             | RS 1104 BELL RADIO TEST FAILED            | Unplanned | Responder | Alstom_C | 6/1/2021 20:17  | 6/8/2021 20:17  |
| 93849      | LRV-1104 | TRAIN 110   | LRV  | LRV-1104 |             | RS1104 LMC2 cab heater wiring             | Unplanned | Open      | Alstom_C | 5/10/2021 22:21 | 5/17/2021 22:21 |
| 93573      | LRV-1104 | TRAIN 110   | LRV  | LRV-1104 |             | RS 1104 - Speed sensor harness replace    | Unplanned | Responder | Alstom_C | 5/9/2021 7:18   | 5/16/2021 7:18  |
| 91380      | LRV-1104 | TRAIN 110   | LRV  | LRV-1104 |             | RS-1104 track brake ground cable          | Unplanned | Responder | Alstom_C | 4/26/2021 11:30 | 5/3/2021 11:30  |
| 85310      | LRV-1104 | TRAIN 110   | LRV  | LRV-1104 |             | RS 1104 B voBC subrack hardwares are mis  | Unplanned | Responder | Alstom_C | 3/19/2021 22:25 | 3/26/2021 22:25 |
| 83341      | LRV-1104 | TRAIN 110   | LRV  | LRV-1104 |             | RS 1104 A - MC1 left tail light           | Unplanned | Responder | Alstom_C | 3/7/2021 13:27  | 3/14/2021 13:27 |
| 59112      | LRV-1104 | CAR A (MC)  | LRV  | LRV-1104 | LRV-1104    | RS 1104BCD roof arches key lock           | Unplanned | Responder | Alstom_C | 10/17/2020 3:58 | 10/24/2020 3:58 |
| 58027      | LRV-1104 | CAR A (MC)  | LRV  | LRV-1104 | LRV-1104    | RS-1104BCD roof fairings Missing C-clip   | Unplanned | Responder | Alstom_C | 10/9/2020 0:41  | 10/16/2020 0:41 |
| 54569      | LRV-1104 | CAR A (MC)  | LRV  | LRV-1104 | LRV-1104    | RS 1104 Side skirt stand                  | Unplanned | Responder | Alstom_C | 9/15/2020 19:34 | 9/22/2020 19:34 |
| 52861      | LRV-1104 | TRAIN 110   | LRV  | LRV-1104 |             | RS 1104 100k AGTU - Functional Tests      | Unplanned | Assigned  | Alstom_C | 9/4/2020 18:59  | 9/11/2020 18:59 |
| 52860      | LRV-1104 | TRAIN 110   | LRV  | LRV-1104 |             | RS 1104 100k AGTU - Change air filter&car | Unplanned | Assigned  | Alstom_C | 9/4/2020 18:51  | 9/11/2020 18:51 |
| 52741      | LRV-1104 | CAR C (IM)  | LRV  | LRV-1104 | LRV-1104    | RS-1104C Broken track break ground        | Unplanned | Responder | Alstom_C | 9/3/2020 20:16  | 9/10/2020 20:16 |
| 52707      | LRV-1104 | CAR B (MC)  | LRV  | LRV-1104 | LRV-1104    | RS 1104 TTCU3 NOT WORKING                 | Unplanned | Responder | Alstom_C | 9/3/2020 15:33  | 9/10/2020 15:33 |
| 51468      | LRV-1104 | CAR B (MC)  | LRV  | LRV-1104 | LRV-1104    | RS 1104-B Wayside Touch Screen No Work    | Unplanned | Responder | Alstom_C | 8/27/2020 13:13 | 9/3/2020 13:13  |
| 44715      | LRV-1104 | CAR A (MC)  | LRV  | LRV-1104 | LRV-1104    | RS 1104-A front light panel cracked       | Unplanned | Responder | Alstom_C | 7/16/2020 6:08  | 7/23/2020 6:08  |
| 42178      | LRV-1104 | TRAIN 110   | LRV  | LRV-1104 |             | RS 1104-A/B/D OVERSIZED WASHER INDUCTOR   | Unplanned | Responder | Alstom_C | 6/23/2020 19:15 | 6/30/2020 19:15 |

**Figure 4.28: Work Order History Display**

Both lists of WOs show items that have been “open” for over six months on each vehicle. Both vehicles were attending the MSF for a key maintenance intervention as scheduled and therefore it would be expected that the vehicles would have all open WOs reviewed, prioritized, actioned and closed to ensure that maintenance backlog work does not continue to increase over time.

The work order governance appears to require review to ensure that there is a common understanding of the order in which a WO can be closed and the length of time that is considered acceptable for a WO to remain open.

## 5 Incidents within the MSF

The following sections contain Mott MacDonald's findings after reviewing and considering incidents that have taken place within the MSF.

### 5.1 Incident Investigation Reports

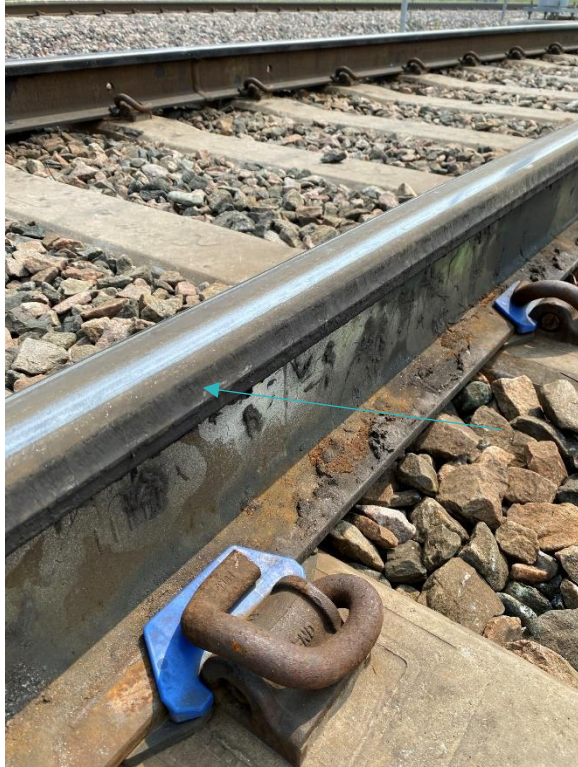
#### 5.1.1 Derailment at Curve 19 on Track 15 (October 18, 2020)

The incident was reported and investigated in Alstom's Incident Report TN-018 Version A (dated 10-11-2020). In this report (page 8 of 25), Alstom have presented an image (**Figure 5.1**) showing evidence of excessive rail gauge face wear from contact with the wheel flange.



**Figure 5.1: Metal Shavings Along Rail Curve 19**





**Figure 5.2: Transposed Rail with Excessive Side Wear Now Moved to the Outside Edge**

In Alstom's report, section 4 Analysis, 4.4 Wheel/Rail Interface, Alstom make the statement "The vertical marks suggest excessive lateral forces at the wheel flange/rail interface and insufficient clearance between flange and rail (i.e., narrow gauge). The presence of metal shavings discovered along curve 19 also supports this finding." The images taken from the Mott MacDonald MSF visit site on August 3, 2021 (**Figure 5.3** and **Figure 5.4**) also show that curve 19 on track 14 still has metal shavings being produced by vehicles traveling over this curve. Although it would be expected to see the metal shavings on the inside of the outer rail as this is where the wheel flange interacts with the gauge face of the rail. However, at the time of the MSF site visit the two rails at this location had been transposed (swapped over) so that the excessive side wear on the outer rail was moved to the outer side of the inner rail. This is a common practice as it allows the track gauge to be restored to normal, but as the track change at this location was already tight to gauge with a worn rail so by transposing the rails this is going to return the gauge back to the original dimension which could be too tight resulting in the possibility of a repeat of previous problems leading up to the derailments within the East connection tunnel and on curve 19 of track 14 within the MSF facility.



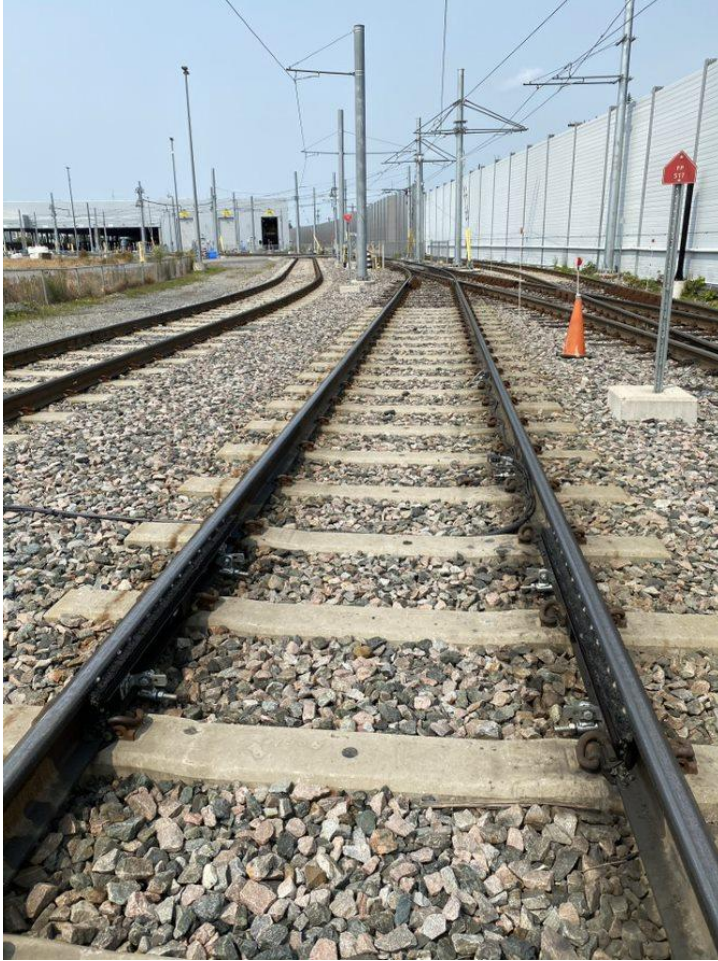
**Figure 5.3 & 5.4: Metal Shavings at Curve 19**

Metal shavings were again seen at the site of curve 19 on track 14 within the MSF. The metal shavings were found on the inside of the rail that formed the largest part of the curve. This would indicate that changes made to the track and vehicles since the derailment of October 18, 2020, have not resolved this issue completely. The continued heavy contact between the wheel flange and the rail head that has produced the metal shavings indicate that there is still a considerable amount friction between the two components, possibly due to the tight track gauge at this location. This may indicate the risk of “wheel climb” at this location is high.

Another item viewed during this site visit and as a result of the derailment on curve 19 on track 14 is the installation of a track-mounted wheel flange lubricator (**Figure 5.5**). This device supplies a lubricant at both rails on curve 19 on track 14. The lubricator applies the oil/grease to the wheel flange as the train passes over the device in either direction. This device does not meter the amount of lubricate applied to the wheel flange as it is a coating bath that the wheel flange will pass through. The track-mounted devices are fed from a reservoir and pumping device installed close by the location. However, the level of oil/grease being picked up by the wheel flanges while passing over the lubricator equipment is being applied in excessive amounts which leads to the lubricant being spread onto the rail crown surface from the passage of the wheels leading to potential wheel/rail adhesion issues (e.g., wheel spin/slide).

This wheel flange lubricator should be assisting in the ability of the wheelsets to pass through the curve with less likelihood of the wheel flange climbing the rail and causing a derailment, however, the evidence of the metal shavings on the rail near to the curve suggest that the wheel flange is still in heavy contact with the rail at this location.





**Figure 5.5: Wheel Flange Lubricator**

### 5.1.2 Derailment at East Connector (November 18, 2020)

This incident was reported and investigated in Alstom's Incident Report TN-024 Version A (Dated 2021-01-13).

Four of the five containment actions from the report were based on the vehicle. Item 4 calls for manual regreasing of all exit/entry tracks into the MSF.

Inspection of the rail found grease on both the gauge face and crown. It is clear that grease is being applied to the gauge face. There is significantly more grease on the rail crown in the area where grease is applied manually, than on the rail through the rest of the connector tunnel. The sand on the rail foot and tunnel floor in this area is also contaminated with grease.



**Figure 5.6: Manual Grease Application Location at East Connector Tunnel**





**Figure 5.7: Grease on Rail Crown at Manual Grease Application Location**



**Figure 5.8: Less Grease on Rail Elsewhere in the Connector Tunnel**

The presence of grease on the rail crown either from manual application to the rail or from the vehicle bourn flange lube applicators will have a significant impact on the tractive effort of the vehicle in both acceleration and braking.

A significant amount of sand was also found on the ground in this area. In some areas, the sand was over 1cm deep. This is an indication that the vehicle is experiencing significant traction and braking issues in this area.



**Figure 5.9: Sand in East Connector Portal Tunnel**



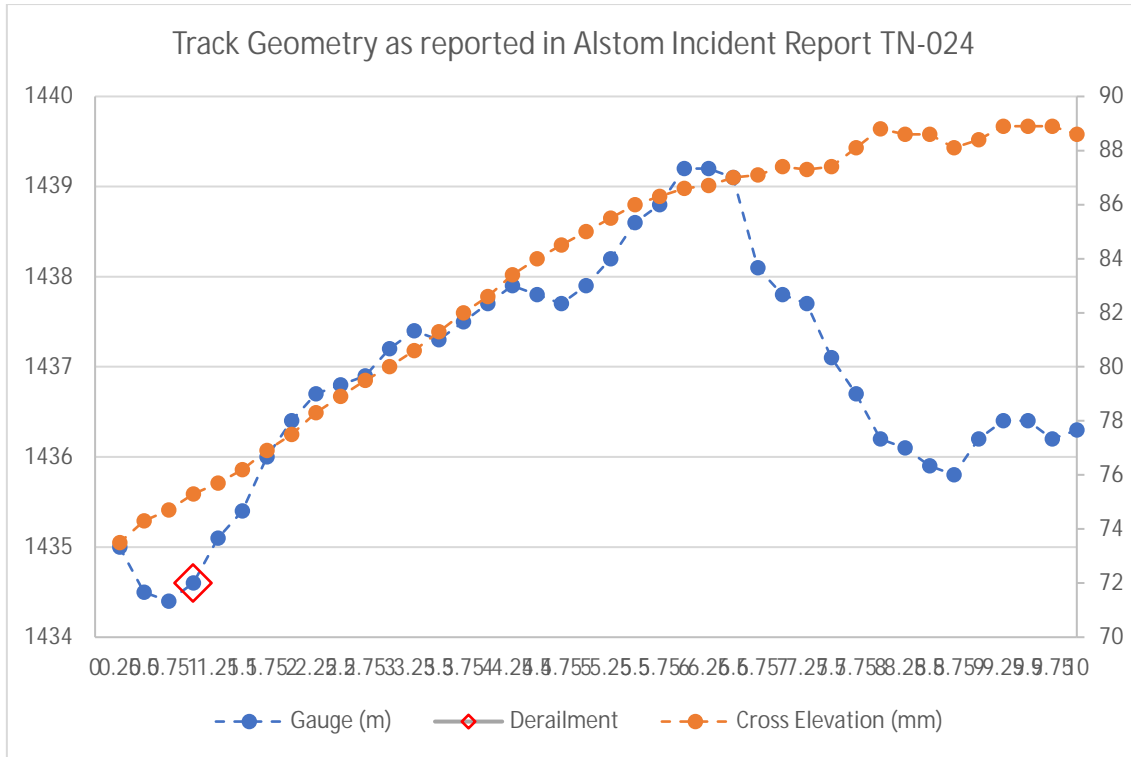
The presence of metal shavings on and near the rail foot at this location, either from the rail or from the vehicle as it passes over this point of the curve appear to show that the vehicles wheel flanges are still having significant contact against the rail gauge face. This is happening in the area before the grease is being applied to the track. As with curve 19, within the MSF yard the vehicle still shows signs of high levels of wheel flange contact and wear with the rail could lead to rail climbing again.



**Figure 5.10: Metal Shaving at East Connector Portal Tunnel**

The Alstom incident report contained 10m of gauge measurements which include the suspected location of the derailment. If the connector tunnel is considered part of the yard, all of these gauge measurements are within the reported tolerances. It is worth noting that the location identified for the rail climb and therefore derailment location is just after the tightest gauge location. There is also a note in Alstom's incident report TN-018 for LRV1126's yard derailment that "per best practices of fail, it is recommended to have gauge widening in sharp curves." The connector tunnel's tightest curve radius is 55.15m.





**Figure 5.11: Track Geometry as Reported in Alstom Incident Report TN-024**

Inspection of the East Connector Tunnel showed that at least some of the conditions leading to the derailment of LRV 1126 still remain. No changes to the rail to address the tight gauge were mentioned or discussed as part of our site visit, nor was extending the checkrail to protect against another derailment in the same location.

It should be noted that since the MSF derailment in Nov 2020 there has been a further, more serious yard derailment in March 2021, at the same tight radius curve location, which has resulted in serious damage to the derailed vehicle due to impact damage from coming in to contact with OCS poles and other wayside equipment. Mott MacDonald have not received detailed information from Project Co regarding this derailment.

## 6 Conclusions MSF

The MSF appears to have been designed and constructed in general accordance with the Project Agreement Schedule 15. However, it should be noted that PA Schedule 15 is structured as an output specification, which is typical of AFP projects, but as such does not include or identify specific requirements for the MSF other than the need for the MSF to be designed, built and maintained by Project Co and that the MSF is to provide for the maintenance of the systems vehicle fleet.

Further, the maintenance areas appear to be reasonably equipped to perform the running type maintenance for the fleet. There are areas set aside for bench test equipment, welding, purpose build bogie stands, lifting jacks and specialized shunting machines to move the trains within the MSFs if required. Similarly, both MSF1 and MSF2 have areas where the overhead power can be provided to the train and the area isolated from workers not approved to be in that location, and both the MSFs also contain overhead cranes that can be used for lifting and moving equipment around the facility. MSF1 and MSF2 locations had good lighting, end doors in the maintenance building and air ventilation in operation during our visit.

The MSF may have been designed and constructed in general accordance with PA Schedule 15-2 and appears to have the required equipment and facilities to support the required operation for running type maintenance; however, Mott MacDonald has identified several areas of concern as they apply to Good Industry Practice that could be applied to the design and operation of this type of facility.

### 6.1 Track Condition and Geometry

Generally, kinks in the rail at weld locations have been observed. At some of those locations the gauge is as tight as 1430mm. Tight to gauge track on the small radius curves combined with severe kinks in the track could lead to potential wheel flange climb resulting in derailment. In addition to issues associated with the track gauge above, general issues with the track geometry were found, most notably at the transition between ballast track and direct fixation fastener (“DFF”) track at the EB and WB Connector tracks.

### 6.2 Vehicle Storage Shed

The design of the storage shed also presents challenges to perform preventative maintenance on the vehicle, most specifically daily and pre-departure inspections. For instance, a chain link fencing divides the storage shed at the centre of the building, which does not allow opening of the side skirts on one side of the vehicle, and due to the proximity of the dividing fences, the entirety of the daily inspection cannot be completed in the storage shed if the vehicle is parked on the centre 2 roads (**Figure 4.1** and **Figure 4.2**). This may lead to staff putting themselves at risk should they attempt to pass between parked vehicles to gain access, for example if there is a need to access the manual brake release handles on the trucks.

### 6.3 Trackwork Loop

One of the main challenges presented by the yard and shop layout design is the lack of a circular track loop around the site. Recognizing that the MSF layout would have been constrained by the land made available, a track loop is typical for most light rail MSF applications and has been adopted as Good Industry Practice both in North America and globally. The current design makes vehicle movements more difficult even for routine operational movements, which results in little or no operational flexibility or redundancy when dealing with day-to-day operational challenges. This is likely to worsen once Phase 2 comes on-line which includes more vehicles being stored/serviced/maintained on-site and a greater number of trains having to be formed into consists. A trackwork loop would allow for efficient flow of vehicles, minimizing train and personnel movements.

## 6.4 Movement Constraints

During our visit to the MSF, it was noted that there appear to be constraints on the movement of vehicles inside the MSF yard. For instance, currently track 11 and the SIW track is utilized for morning launch. As the morning launch schedule is tight, up to five consists are staged on these tracks back through the yard curves. Any last-minute defects which occur during this process disrupt the launch wave. This also means that there are very limited options for moving a defective vehicle out of the way and into a LMB.

Similarly, the evening retrieval routes all consists through the SIW track for a partial daily inspection. Due to the rapidity of the retrieval waves, there is not enough time to perform a complete daily inspection in the SIW track.

In order to deal with the Phase 2 expansion and increase in fleet size, the MSF site has included the addition of the MSF2 maintenance building and the extension of the LRV storage shed. However, the operational flow of the site to ensure the fleet can be launched and returned to the site effectively does not appear to have been considered as the current arrangement struggles to deal with the existing Phase 1 service requirements. This situation will likely be compounded once Phase 2 service is added.

The German VDV Recommendation on the Design of Depots for LRVs and Tramcars, is used globally and recognized as an example of Good Industry Practice. This includes a recommendation for when the quantity of vehicles to be taken as a basis is to be determined, the increases in the fleet and the vehicle sizes (types) expected within a foreseeable period are to be considered. Based on the operational efficiency of the current MSF layout this does not appear to have been factored into the design (e.g., not future proofed).

## 6.5 Miscellaneous Equipment Faults

There are various equipment faults that are affecting the movement of trains in the yard. For instance, it appears that when vehicles try to enter LMBs 1 & 2 from the east side of MSF1, the main fuse associated to LMBs 1 or 2 is blown and overhead power turns off. The maintenance team has adapted to this issue by not running vehicles from the east side of the yard into LMBs 1 & 2, but this issue adds to the movement challenges present in the yard and will only worsen once normal service requirements return. The solutions proposed in Project Co's Rectification Plan (City Reference b)14) need to be fully implemented and the fix verified to remove the ongoing constraint.

Similarly, on track 7 there is a light fixture that indicates the status of the overhead catenary traction power supply which illuminates green when the catenary is energized, which would typically indicate a de-energized catenary. Currently, the status light is covered with a paper coffee cup by staff to avoid confusion. This is a potential safety hazard for all staff including other personnel that may not be aware of the issue, e.g., subcontractors, and as such, an investigation and proper solution should be implemented as soon as possible.

## 6.6 Operational Processes

Another aspect that adds to the challenges presented by the facilities and yard design is the operational requirement to obtain authorization from yard control to go from one building to another one. For example, to go from MSF1 to MSF2, a hostler or any authorized personnel has to contact yard control to exit MSF1 and request authorization to enter MSF2. The same process applies to enter/exit the storage shed. It is unclear why authorization is needed to go from one building to another one, understanding that to do so a hostler does not have to enter the yard or cross any tracks.

## 6.7 Asset Management Plan

During the visit to the MSF, Mott MacDonald inquired to the status of the AMP and were informed that an updated AMP was not yet complete but will be available soon. The AMP should be prepared and updated

in accordance with the PA as the project develops and progresses through its lifecycle, and would help Project Co and its suppliers meet the requirements of the City and show a clear path of how Project Co is ensuring that the City's assets are being managed and maintained throughout their operational design life.

## 6.8 Revenue Vehicle Maintenance Processes

Having reviewed maintenance processes in the MSF it appears that Project Co does not have maintenance and configuration control practices that create the necessary data to provide traceability and continuity on how often assets have been adjusted, how long they have run, and the magnitude of any adjustments and replacements have been made, and thus be able to apply a proactive approach to asset management.

## 6.9 Incidents within the MSF

While Project Co appear to be satisfied that the issue is resolved, the presence of metal shavings found at the same location during the Mott MacDonald MSF visits is would indicate that changes made to the track and vehicles since the derailment of October 2020 have not resolved this issue.

Similarly, there was a significant amount of grease found in the East Connector, at the location of the November 2020 derailment. The grease is being applied manually by staff in large quantities to the gauge face of the rails in key locations where derailments have occurred. This may be helping the vehicles to negotiate the curves by limiting noise and potential risk of the wheel flange climbing the rail leading to derailments. However, the thickness of the grease being applied is leading to the wheel flanges squeezing the grease on to the rail crown which is subsequently spread along the surface of the rail crown by the passage of the wheel treads. This in turn, collects on the wheel tread surface and can then be spread across the system which has been observed in several locations. The presence of grease on the rail crown will have a significant impact on the tractive effort of the vehicle in both acceleration and braking.

A significant amount of sand has been observed on the ground in the East Connector area and in other areas around the system including in station areas. This is an indication that the vehicle is experiencing significant traction and braking issues in the area due to wheel slip/slide taking place even during dry weather, which may be caused by the grease being applied, and may indicate that the issues in this location are not yet resolved. In addition to the observations in the MSF the presence of grease on the rail crown and wheel treads may be contributing to the known train stopping issues caused by overshooting, it is recommended to carry out a more detailed analysis of the process to apply the grease and possible consequences of applying grease manually in such quantity.

Our priority recommendations as they apply to the facilities, equipment and operation of the MSF are captured later in this Volume, and collated with the recommendations from all Volumes in Volume 6.

## 7 Recommendations - MSF

The following are the recommendations that Mott MacDonald has made for consideration, after our review of the MSF and yard processes. The list below is grouped by priority to identify those tasks we believe that Project Co should undertake immediately and those which could be completed in the medium-term.

Please note that many of our recommendations could impact the Project design, and so Project Co will need to agree with the recommendations made and provide design drawings/ information/plans to implement the changes.

### 7.1 Priority Recommendations

1. Bypass Track – The bypass track (track 14) is not currently commissioned as its part of Stage 2. This appears to be an unnecessary constraint on the current movement of vehicles within the MSF site, especially in light of the land-constrained site and absence of a track loop. It is recommended the introduction of this bypass track is considered as it could be used to facilitate the movement of vehicles in and out of the MSF at busy times such as when the fleet enters or returns from daily service, this could ease the operational constraints the current layout is creating by providing more flexibility.
2. Traction Power Grounding – The traction power for MSF 1 and the yard are powered through different supplies, the MSF 1 is grounded, and the yard is floated, causing a sudden rush of current, which causes the fuse to blow to protect the system. A temporary mitigation was proposed and implemented, by limiting train operation and bringing vehicles only through the west side of the Maintenance building. The Rectification Plan went on to propose a technical solution to replace the fused design with a new Stinger Panel. It is recommended that Project Co provide evidence that the solution was implemented, or a revised Rectification Plan indicating when the solution will be implemented.
3. Catenary Power Indicator Light – On track #7 the light fixture that indicates the status of the overhead catenary, falsely indicates a de-energized catenary when the catenary is energized. Under normal conditions, when the catenary is energized, the red light indication should be “on” and when the catenary is de-energized, the green light should be “on.” However, it was noticed that with the catenary energized, the green light was “on,” falsely indicating a de-energized catenary. Although Project Co and Alstom personnel are aware of this situation, the issue has not been properly addressed. This is a potential safety hazard for other personnel that may not be aware of the issue, e.g., subcontractors, and as such, an investigation and proper solution should be implemented as soon as possible.
4. Tight Track Gauge – At several curves the track gauge is tight (i.e., less than 1435mm). To minimize the risk of derailment throughout those curves, it is recommended to adjust the track gauge by replacing the plastic spacers on the ties – similar to what has been done before on curves C18, C19 and C20.

### 7.2 Additional Recommendation

5. Shop Equipment – It is recommended the floor areas and available power supplies are assessed to ensure their suitability for conducting vehicle lifting activities (e.g., floor reinforcement).
6. Brake Inspection Processes – It is recommended to determine the reasoning behind the decision to inspect the friction brake system on a daily basis, as modern LRVs typically do not require a daily inspection check unless there is an underlying need.
7. Corrective Actions – To provide supporting data and demonstrate that corrective actions put in place are having the desired effect it is recommended that Alstom be requested to submit sample measurements, new/worn tolerance values and inspection records for wheel truing, wheel wear recording, and flange lubrication as well as type/qualification tests for the new sand.



8. Flange Lube Equipment – It is recommended that Alstom review the procedure and the maintenance instructions related to the setting of the flange lubrication equipment following wheel truing and wheel replacement in order to ensure the alignment is related to the relevant wheel diameter and flange position. This may also require a formal re-training of staff to ensure they are aware of the process necessary to ensure the alignment is correct and made aware of the implications of incorrectly setting the flange lubricator spray nozzles.
9. Grease Application – In addition to the observations in the MSF the presence of grease on the rail crown and wheel treads may be contributing to the known train stopping issues caused by overshooting, it is recommended to carry out a more detailed analysis of the process to apply the grease and possible consequences of applying grease manually in such quantity.
10. MSF WRI – The transposing of the two rails at the curve location in the yard, where the derailments have occurred, has been done to relocate the rail with the excessive side wear to the inside rail position in order to restore the track gauge. However, the track gauge could now be too tight resulting in the possibility of a repeat of previous problems leading up to the recent derailments. It is recommended to carry out a further analysis of the wheel rail interface at this location, including but not limited to comparing track gauge against bogie steering capability, wheel back-to-back dimensions, and wheel tread and flange profiles.
11. Camber Angle Assessment – In addition to the wheel/rail interface observations identified in recommendation #6 above, Alstom's proposed implementation of a fleet wide modification (reference: Design IPONAM T20) to the bogie axle beam to address the initial V5 design wheel camber misalignment, which according to Alstom has an impact on the wheel back-to-back dimension, should be assessed further as it is unknown if the current camber angle and back-to-back dimension has any influence on the current wheel/rail interface in respect to the track gauge, rail wear, and potential wheel flange climb and derailment issues previously discussed in Section 3.4 above.
12. SIW Track Use – Due to the facility and yard limitations, the SIW track is used to launch vehicles for revenue service in the morning hours. It is important to note that this track was not designed for this purpose and as such this practice is not recommended as staff are likely to be working/walking within this building while train movements are taking place.

# **Volume 5: Revenue Vehicles**

April, 2022  
Confidential

# Contents

|  |            |
|--|------------|
| Volume 5 Summary                                 | i          |
| Introduction to Volume 5                         | ii         |
| 2.1 Approach                                     | ii         |
| 2.2 Document Review                              | ii         |
| <b>3 Technical Considerations</b>                | <b>145</b> |
| 3.1 Revenue Vehicles                             | 145        |
| 3.1.1 Information Gathered from Document Review  | 145        |
| 3.1.2 Vehicle Reliability Data                   | 145        |
| 3.1.3 HVAC                                       | 152        |
| 3.1.4 Vehicle Compressor                         | 152        |
| 3.1.5 Vehicle CCTV                               | 153        |
| 3.1.6 Wheel Related Observations                 | 154        |
| 3.1.7 Wheel Flange Lubrication System            | 160        |
| 3.1.8 Abnormal Pantograph Carbon Wear/Damage     | 161        |
| 3.1.9 Line Inductor (Roof Flashovers)            | 164        |
| 3.1.10 Configuration Management                  | 172        |
| 3.1.11 Line Contactor                            | 174        |
| 3.1.12 Auxiliary Converter (APS)                 | 174        |
| 3.1.13 High-Speed Circuit Breaker                | 177        |
| 3.1.14 Passenger Doors                           | 179        |
| 3.1.15 Vehicle Braking                           | 181        |
| 3.1.16 Sanding System                            | 182        |
| 3.1.17 Speed Sensors                             | 184        |
| 3.1.18 Cracked Wheels                            | 185        |
| <b>4 Mainline Derailments</b>                    | <b>186</b> |
| <b>5 Recommendations – Revenue Vehicles</b>      | <b>189</b> |
| 5.1 Revenue Vehicles - Priority                  | 189        |
| 5.2 Revenue Vehicle – Additional Recommendations | 191        |

## Figures

|  |     |
|--|-----|
| Figure 3.56: Vehicle Cumulative Mileage                            | 147 |
| Figure 3.57: Quantity of Backlog of Deferred Maintenance           | 148 |
| Figure 3.58: Examples of traction converter containers at Brampton | 149 |

|  |     |
|--|-----|
| Figure 3.59: Vehicle Reliability - All Events - May to Sept 2020   | 151 |
| Figure 3.60: Vehicle Reliability - Service Affecting Events - May to Sept 2020                             | 151 |
| Figure 3.61: Coarse Machining Lines Observed During Site Inspection  | 155 |
| Figure 3.62: New Wheel with No Coarse Machining Lines  | 155 |
| Figure 3.63: Chart of Wheel Diameter Pre and Post Wheel True   | 157 |
| Figure 3.64: Chart of Back-to-Back Measurements Pre and Post Wheel True                                    | 159 |
| Figure 3.65: Missing Flange Lubrication Spray Nozzle   | 160 |
| Figure 3.66: Incorrectly Set Flange Lubrication Spray Nozzle   | 160 |
| Figure 3.67: Current Project Co. Pantograph Force Check  | 161 |
| Figure 3.68: Example of Pantograph Contact Force Check   | 162 |
| Figure 3.69: Inductor compartment of a typical traction case, after 75000 km                               | 164 |
| Figure 3.70: Arcing Events vs Climate  | 164 |
| Figure 3.71: On the Left the Prototype; On the Right Serial Number 169                                     | 165 |
| Figure 3.72: Serial number 169: Single Layer of Nomex On The Individual Conductors                         | 165 |
| Figure 3.73: Serial Number 169: Missing Tape and Filler  | 166 |
| Figure 3.74: Proposed Short-Term Mitigation  | 167 |
| Figure 3.75: Proposed Case Modifications to Improve the Environment  | 168 |
| Figure 3.76: Use of Insulating Cups on the Terminal Support Bolts  | 169 |
| Figure 3.77: Use of Insulating Channels on the Terminal Support Bolts                                      | 169 |
| Figure 3.78: Proposed Creep Distance Improvement   | 170 |
| Figure 3.79: Line Inductor Major Issue Plan – From Project Co Rectification Plan                           | 170 |
| Figure 3.80: New Line Inductor Cover   | 171 |
| Figure 3.81: New (Left) and Original (Right) Line Inductor Ventilation Covers                              | 172 |
| Figure 3.82: Roof-Mounted Traction Converter Diagram Showing Line Inductor/Ventilation Cover Locations     | 172 |
| Figure 3.83: Previously Used Traction Converter Installed on LRV1152                                       | 173 |
| Figure 3.84: Propulsion Converter Indicating the Wrong Voltage and Using the Old-Style Line Inductor Cover | 174 |
| Figure 3.85: Major Issue Plan (APS)  | 176 |
| Figure 3.86: Pre-Used APS Unit Installed   | 177 |
| Figure 3.87: APS Units on The Brampton Facility Shop Floor   | 177 |
| Figure 3.88: Major Issue Plan (HSCB)   | 178 |
| Figure 3.89: Citadis Sprit 404 - 1500Vdc HV Supply Circuits  | 179 |
| Figure 3.90: Photo of New Coarser Sand   | 182 |
| Figure 3.91: Photo of Original Powdery Sand  | 183 |
| Figure 3.92: Wheel Parts Including Socket Screws   | 185 |
| Figure 4.33: LRV1121 Derailment September 2021   | 186 |
| Figure 4.34 and Figure 4 35 LRV1119 Derailment August 2021   | 187 |

# Volume 5 Summary

The purpose of this Volume is to summarize Mott MacDonald's findings regarding the review Revenue Vehicles, as well as providing a summary of recommended changes or repairs or upgrades that are required to improve the performance of the Project systems, and Project Operations and Maintenance.

Revenue service vehicle reliability reports, maintainability and reliability reports, site visits, failure reports, part drawings, and maintenance manuals were reviewed to evaluate the effectiveness of Project Co's Rectification Plan and their adherence to the PA. Review was limited by incomplete specific information, data, and documentation requested from Project Co to support implementation of the Rectification Plan.

It is worth noting that the Failure Points do not give the full picture of operational issues. In the months for which Alstom's Reliability Reports have been provided to Mott MacDonald, the number of both service and non-service affecting reliability events is significant (mostly communications events), including during the period when Vehicles Kms Availability ratios are below the thresholds established in the Project Agreement. There is limited accurate data/information gathering that is required to monitor that the changes to infrastructure and on-board equipment including modifications are having the desired effect or not, and Mott MacDonald has serious concerns that Project Co's ability to meet its performance requirements, including vehicles' availability ratios, is at risk for the following reasons:

- An increasing backlog of deferred maintenance tasks
- A lack of accurate data/information gathering that is required to monitor whether or not changes to infrastructure and on-board equipment including modifications are having the desired effect
- Known technical issues that have a potential impact on Vehicles Kms Availability and could subsequently translate into Failure Points/Project Co Event of Default
- The expectation that other identified technical issues will be under increased tension when ridership increases after the COVID-19 pandemic

These items are discussed throughout the various Volumes of this report, and all recommendations made by Mott MacDonald are captured in Volume 6, for ease of reference.



# Introduction to Volume 5

The purpose of this Volume is to summarize Mott MacDonald's findings regarding the review Revenue Vehicles, as well as providing a summary of recommended changes or repairs or upgrades that are required to improve the performance of the Project systems, and Project Operations and Maintenance.

## 2.1 Approach

As part of this ongoing review, Mott MacDonald also conducted an assessment of the process for planning, preparing and executing the servicing, maintenance and operation of the vehicles as required for continuing operation of the Project.

Revenue service vehicle reliability reports, maintainability and reliability reports, site visits, failure reports, part drawings, and maintenance manuals were reviewed to evaluate the effectiveness of Project Co's Rectification Plan and their adherence to the PA. Not all reports/data were available in a full state of completion during the review period; a list of reviewed documents follows, in Section 2.2.

Mott MacDonald conducted a review of available background material and assessed failures/issues against defined City requirements and Project Co derived requirements, investigated the design, and validated remedial activities implemented. Early-stage investigations were then used to guide later stages of the study when more in depth data collection, and site reviews and assessments, were carried out. On-site visits were made:

- September 2020: Observation of maintenance activities
- August 2021: On-site visit to the MSF to observe vehicle maintenance practices, operational efficiency of the MSF design, and inspection of the previous vehicle derailment locations in the yard and lead track portal tunnel
- August and September 2021: On-site support following the second of two mainline derailments in six weeks (at the City's request)
- Ongoing Meetings: Held with the City and Project Co staff, as needed.

The results of the review are described later in this Volume and include Mott MacDonald's determination of required interventions, to identify actions against sources of unreliability, and deliver maximum benefit to System performance in the least amount of time.

## 2.2 Document Review

The document review included the Project Agreement and project specification requirements for Revenue Vehicles, along with the following documents from Project Co:

- Monthly Performance Monitoring Reports
- List Contract Deliverables to identify what was required and what has been delivered
- Integration Matrix and supporting documentation
- Issues list and Risk Register
- Traceability Matrix – potentially any lower-level derived specifications (if possible) and select verification/validation (analysis, testing, etc.) documents
- Interface Control Document (or similar)
- Maintenance plans

- Documentation relevant to known failures/issues and Project Co's Rectification Plans

Thirty (30) document requests were tracked via a Mott MacDonald's RFI log, which is included in Volume 7. At this time, while some of these RFIs have been partly addressed, responses to RFIs submitted to Project Co on these issues remain outstanding. These include the following RFIs:

- Rolling Stock RFI 09, 010, 011, 012, 025, 026, 28, 30

The specific impact of the lack of response is difficult to define, as it changes for the specifics of each case. In the absence of documentary evidence, Mott MacDonald has provided assessment of whether the proposed rectification was likely to mitigate the given issue.

## 3 Technical Considerations

### 3.1 Revenue Vehicles

Revenue service vehicle reliability reports, maintainability and reliability reports, site visits, failure reports, part drawings, and maintenance manuals, as made available, were reviewed to evaluate the effectiveness of Project Co's Rectification Plan and their adherence to the PA. To the extent possible, each subject has been evaluated to understand the potential root causes.

#### 3.1.1 Information Gathered from Document Review

Mott MacDonald reviewed the revenue vehicles information by comparing the Output Specifications against the Rectification Plan, incident logs, and typical availability/performance (with detailed references provided below).

References used throughout this Volume of the report are also listed in Volume 7.

##### 3.1.1.1 RailPod Data Analysis

The RailPod data was analyzed by potential impact the infrastructure may have on the vehicles, and likewise, what the vehicle condition (from a maintenance perspective) or design may influence known infrastructure issues such as rail head corrugation. For example, the survey has identified variations in track gauge including potential tightness to gauge, especially through tight curves, which is an area that requires further specific analysis to look at key items such as the construction and maintenance standards of the track, wheel profile/wear tolerances, bogie suspension, rotational stiffness, and potential derailment risks.

Based on Mott MacDonald's observations and findings to date, including an initial assessment of the November 2020 Alstom report for the MSF derailment; the Project Co Response to OCT Investigation Status Derailment of LRV1126 report dated March 8, 2021; and rail corrugation seen across the System, a recommendation was made to the City to conduct a detailed wheel/rail interaction study to determine if the optimal wheel and rail profiles are being used. Vehicle dynamic modelling software, such as SIMPACK, Vampire or Nucars could be used to aid this study, which should seek to optimize the wheel and rail profile to minimize rail/wheel damage by ensuring good steering through curves while minimizing hunting. The study should also consider if changes to the track or vehicle would be beneficial, and how the new profiles would develop with wear over time. Finally, the study should consider whether the existing lubrication is sufficient or whether trackside lubricators are required given the high levels of wear.

Mott MacDonald have provided an outline scope of work proposal to the City for carrying out an independent wheel/rail interface study, due to difficulties in obtaining the relevant technical data from Project Co that is required to conduct this study the work has been put on hold.

#### 3.1.2 Vehicle Reliability Data

##### 3.1.2.1 PA Reference

From "OLRT -Scope 5 – Schedule 15-3 Maintenance and Rehabilitation" Appendix B Asset Preservation, 6.0 Asset Preservation Performance Measures, (f) Vehicles and Systems, (ii) Vehicles and Systems Condition Data Collection and Reporting:

A. Project Co is responsible for collecting Vehicle and Systems condition data for the purposes of Asset Management and measuring performance achievement based on the requirements of Appendices A and C of this Schedule. The collection of Vehicle and Systems condition data shall occur as part of Project Co’s ongoing inspection, testing and monitoring activities as required and specified for vehicle and systems assets and their subcomponents by regulation, industry standards and practices, and/or as necessary for Project Co to execute its maintenance obligations as specified in Project Co’s maintenance plans.

B. Project Co shall utilize inspection, testing and monitoring data including, but not limited to, the information required for reporting per Appendix A, Article 1.8 to assess the condition of vehicle and systems assets and their subcomponents, to monitor trends, and proactively program asset management actions. Such data, trends, and programming asset management activities shall be included in the annual reports as required in accordance with Article 5 of this Appendix.

### 3.1.2.2 Revenue Vehicle Cumulative Milage

A review of the quarterly reports provides an overall indication of the attention given the maintenance and data recording activities related to rail vehicles. Five quarterly maintainability and reliability reports were made available for review, dated January 2020 to January 2021. Current quarterly reports have been requested to help determine if the Project Co’s Rectification Plan is working in terms of improving fleet reliability and availability; however, these later reports are still outstanding.

An evaluation of the available cumulative milage data from January 2020 to January 2021 shows that there are four vehicles whose mileage inexplicably declined, highlighted in red below. Without knowing if the vehicle mileage is obtained remotely by data transfer or manually written down by the maintenance/operational team from the vehicle odometer reading (e.g., displayed in the cab) we are unable to determine the cause. However, this could be down to human error and/or the odometer may have been removed/replaced from another vehicle.

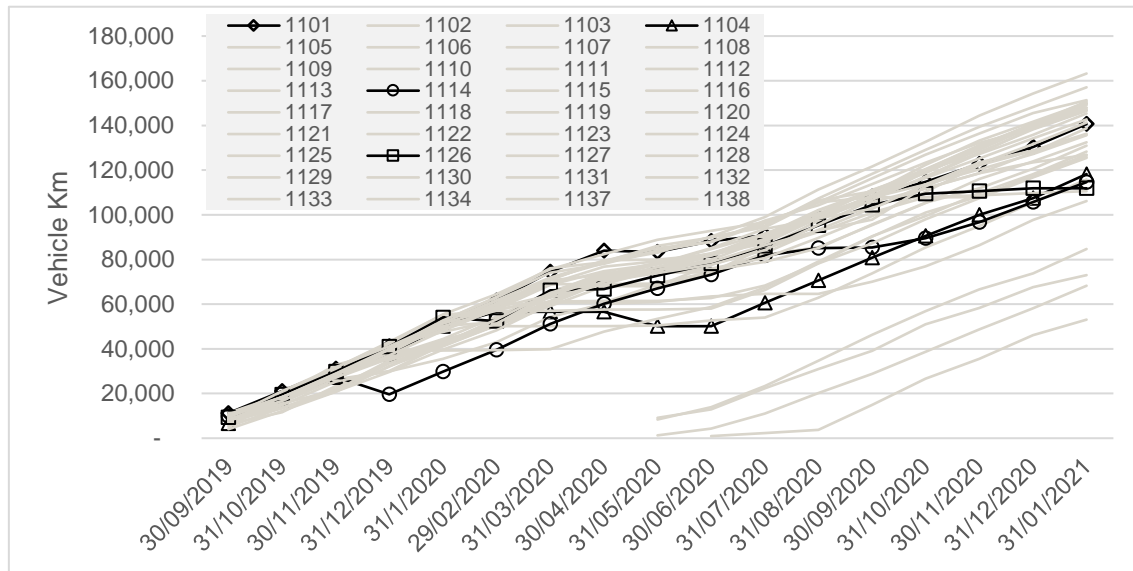
|          |          |          |          |
|----------|----------|----------|----------|
| LRV 1101 |          |          |          |
| Apr 2020 | May 2020 | Jun 2020 | Jul 2020 |
| 83,984km | 83,325km | 88,300km | 90,761km |

|          |          |          |          |          |          |          |
|----------|----------|----------|----------|----------|----------|----------|
| LRV 1104 |          |          |          |          |          |          |
| Jan 2020 | Feb 2020 | Mar 2020 | Apr 2020 | May 2020 | Jun 2020 | Jul 2020 |
| 50,159km | 56,584km | 56,584km | 56,584km | 50,092km | 50,092km | 60,620   |

|          |          |          |
|----------|----------|----------|
| LRV 1114 |          |          |
| Nov 2019 | Dec 2019 | Jan 2020 |
| 27,531km | 19,668km | 29,783km |

|          |          |          |
|----------|----------|----------|
| LRV 1126 |          |          |
| Jan 2020 | Feb 2020 | Mar 2020 |
| 54,006km | 52,293km | 66,233km |

**Figure 3.56: Vehicle Cumulative Mileage**



Source: Alstom Monthly Reliability & Maintainability Reports

Vehicle mileage is one of the most significant metrics for vehicle system, so is an important measurement tool for the equipment and systems life cycle.

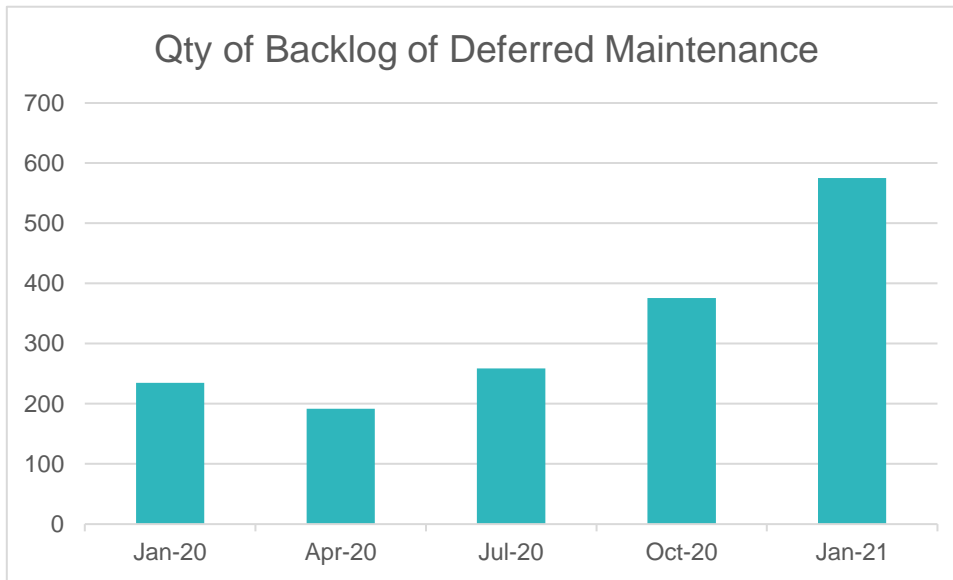
**3.1.2.3 Backlog of Deferred Maintenance**

The backlog of deferred maintenance is included in the MSC Monthly Reliability & Maintainability Report September 2019 to January 2021. It is typical for maintenance tasks to be created in the Maintenance Management System and to remain until the work is completed. The presence of this information in the report shows that this metric is being tracked, captured and reported.

Section 2.5 of the MSC Monthly Reliability & Maintainability shows that in January 2020, there were 235 deferred items, and in January of 2021 there were 575, more than double. Up-to-date reports have been requested to determine if the deferred items are showing a downward/upward trend from January 2021 to present day; however, these later reports are still outstanding. This data is an indication that the open maintenance tasks are increasing, rather than reducing or staying relatively constant. This analysis also highlights a high number of possible vehicles being stopped for long periods of time due to components either missing due to them being reused to keep other revenue vehicles operational or defective.

It is recommended that an independent review of these vehicles and associated materials/equipment is carried out as part of an overall asset condition assessment, as it's likely these assets may deteriorate if left in an inoperable condition for long periods of time.



**Figure 3.57: Quantity of Backlog of Deferred Maintenance**

Source: Alstom Monthly Reliability & Maintainability Reports

Additionally, there are 40 tasks which have been deferred for 12 months, and another 28 which have been deferred for 15 months. Of these 28 tasks, eight were not continuously listed in every quarterly report. It is not clear if these tasks were re-opened or if they were not included in the deferred maintenance backlog list.

Further analysis after the January 2021 report has not been possible, as the requested additional reliability and maintainability reports have not been provided.

There are a few of these long-term deferred maintenance tasks of particular note, based on the description:

- # 60 335 225, LRV1122, Pantograph limit switch damaged, listed across 12 months
- # 60 420 334, LRV1114, battery corrosion, 12 months
- # 60 639 282, LRV1146, HVAC Smoke detectors, 15 months
- # 60 373 009, LRV1142, HVAC Smoke detectors, 15 months
- # 60 374 008, LRV1144, HVAC Smoke detectors, 15 months
- # 60 384 814, LRV1145, Smoke detectors, 15 months
- # 60 384 815, LRV1143, 4 missing smoke detectors, 15 months
- # 60 374 559, LRV 1146, missing battery vent caps, 15 months
- # 60 379 746, LRV 1143, line inductor robbed, 15 months

Seven of the 15-month, long-term, deferred maintenance tasks are from vehicles which are not listed in the cumulative mileage charts included in the quarterly reports. Based on the fact many items similar to those listed above, and within the report, would prevent the vehicles from operating with missing/defective components, it can be assumed these vehicles are out of service and awaiting replacement parts/rectification.

This data of backlog of deferred maintenance indicates a maintenance system which appears to not be controlling and managing maintenance tasks, including corrective and preventative maintenance tasks. In addition, the preventative maintenance plan should be catching, correcting, and preventing many of the items identified in the deferred maintenance list.

This information combined with the improved availability reporting indicates that Project Co is focusing maintenance resources into keeping the fleet in service, but other maintenance tasks are accumulating. This will be compounded by two factors. First, once the passenger numbers return to a more normal state the COVID-19 reduced service will end, and full/normal service will resume. This will increase demand for service vehicles. Second, based on our Brampton on-site Vehicle Inspector observations it appears that Alstom are using uninstalled new parts originally destined for new vehicle assembly, as well as components from vehicles already delivered to support maintenance activities. Once the full fleet of vehicles have been delivered, these resources may not be available.

**Figure 3.58: Examples of traction converter containers at Brampton**



Source: Mott MacDonald Resident Inspector at Brampton Production Facility

These examples of traction converter containers appear to have already been in service on a vehicle still under assembly at Brampton. Note the difference between other new roof equipment containers and the carbon-stained equipment containers, and a mix of both modified/unmodified line inductor ventilation covers.

Listing from OTT-GNR-ENG10-REP-004 – Maintainability Reliability January 2021, Section 2.5 Backlog of Deferred Maintenance which indicate that components from delivered vehicles are being utilized for maintenance activities. Their presence on the deferred maintenance list implies that adequate numbers of spare parts are not available for the initial maintenance action, nor to replace these redirected parts. See examples below from the above report for reference:

- # 60 369 282, LRV 1143, 4 missing smoke detectors, 2020-01-07
- # 60 379 746, LRV 1143, Line Inductor **Robbed** [emphasis added], 2020-01-16
- # 60 504 704, LRV 1146, RIOM Taken from TS46 to TS4, 2020-07-08
- # 60 591 385, LRV 1145, PCEs Taken for Phase 1, 2020-10-07
- # 60 623 357, LRV 1143, B Air Compressor Taken, 2020-11-08
- # 60 662 052, LRV 1107, Pantograph missing, 2020-11-23
- # 60 662 485, LRV 1107, Line contactors missing MC1/IMC/MC2, 2020-11-23
- # 60 679 307, LRV 1107, Motor Cables and Ground Taken, 2020-12-04
- # 60 685 607, LRV 1107, APS 1 Missing, 2020-12-08
- # 60 685 608, LRV 1107, APS 2 is missing, 2020-12-08
- # 60 685 609, LRV 1107, PPU LMC1 is missing, 2020-12-08
- # 60 685 611, LRV 1107, Radio handset missing MC2, 2020-12-08
- # 60 685 613, LRV 1107, Cab to Cab phone missing, 2020-12-08
- # 60 685 617, LRV 1107, MC2 RIOM missing, 2020-12-08
- # 60 685 680, LRV 1107, HVAC control pane missing, 2020-12-08

This report has been developed under a privileged and confidential assignment on behalf of the City of Ottawa. While the report has been prepared for release to City Council as requested by the City and counsel for the City, neither the City nor its' counsel waive privilege over the overall assignment.

- # 60 685 681, LRV 1107, Network Switch missing, 2020-12-08
- # 60 685 692, LRV 1107, EBCC LMC2 Missing, 2020-12-08
- # 60 693 160, LRV 1107, Cab doors missing, 2020-12-13
- # 60 693 163, LRV 1107, TIU Antenna attenuators missing, 2020-12-13
- # 60 693 166, LRV 1107, Lighting panel missing LMC2, 2020-12-13
- # 60 693 168, LRV 1107, LHS Sanding Hose missing MC1, 2020-12-13
- # 60 694 457, LRV 1107, SDU missing in LCC, 2020-12-14
- # 60 702 768, LRV 1107, RIOM2 Missing, 2020-12-20
- # 60 702 769, LRV 1107, Accumulator Missing, 2020-12-20
- # 60 703 281, LRV 1107, Air valve taken, 2020-12-20
- # 60 716 776, LRV 1135, Speed sensor harness missing, 2021-01-01
- # 60 717 005, LRV 1135, Sander Nozzle Taken AXLE 01, 2021-01-01
- # 60 722 291, LRV 1107, TBH Panel LMC1 Taken, 2021-01-06
- # 60 722 292, LRV 1107, WSS4 LMC2 Taken, 2021-01-06
- # 60 723 127, LRV 1142, APS 2 is missing, 2021-01-06
- # 60 724 708, LRV 1143, Pantograph Taken for TS24, 2021-01-07
- # 60 731 504, LRV 1135, Air compressor 1 missing, 2021-01-12
- # 60 734 612, LRV 1107, LMC1 LHS Motor missing, 2021-01-14
- # 60 744 177, LRV 1149, CVS 1 Taken for Stock, 2021-01-21
- # 60 744 179, LRV 1149, CVS 2 Taken for Stock, 2021-01-21

The high number of repeat items listed across the fleet in the report would indicate there are several key items of equipment that are suffering from premature failure, which would typically impact vehicle reliability and availability. However, as previously discussed in Section 2 above, there have been no Failure Points reported by Project Co for Vehicles Kms Availability since September 2020. The large number of deferred maintenance tasks including missing/defective components listed in the report are in contrast with no vehicle Failure Points being triggered. It is recommended that a detailed independent analysis of these items be completed along with a look at backlogged component orders.

#### 3.1.2.4 Fault Log Data

The limited data provided to date does not provide the detail required to evaluate the consistency of the source of system failures. As this data was collected during the spring and summer of 2020, it is not representative of the true vehicle performance during autumn and winter of 2019, when many of the major issues occurred. Also, the basis of the criteria of a service affecting failure is not clear. Additional data is needed from earlier in 2020, and through the end of 2020 to evaluate the true effectiveness of the Rectification Plan on reducing failures **Figure 3.59** and **Figure 3.60** show all vehicle reliability and service affecting events as reported in the Alstom monthly reliability presentations from May to September 2020 (no Alstom data prior to or after these dates was available to Mott MacDonald).

It is important to note that the vehicle reliability “all events” as shown in **Figure 3.59**, indicates an upward trend for several of the systems listed including communications which has shown an increase for each consecutive month from May to September.

Likewise, **Figure 3.60** shows an increase in service affecting failures for the traction system which accumulates to 23 failures for the same period. Also note that the traction system “all events” increased, for a total of 73 defects.

**Figure 3.59: Vehicle Reliability - All Events - May to Sept 2020**

Vehicle Reliability - All events

|                  | May        | June       | July       | Aug        | Sep        | Total       |
|------------------|------------|------------|------------|------------|------------|-------------|
| Communication    | 119        | 123        | 184        | 173        | 200        | 799         |
| Carbody          | 26         | 37         | 45         | 40         | 20         | 168         |
| On-board info    | 15         | 31         | 37         | 48         | 37         | 168         |
| HVAC             | 19         | 21         | 21         | 48         | 40         | 149         |
| Mechanical brake | 24         | 32         | 36         | 29         | 25         | 146         |
| Passenger doors  | 30         | 16         | 14         | 38         | 44         | 142         |
| Traction         | 7          | 13         | 9          | 12         | 32         | 73          |
| Bogie            | 6          | 6          | 10         | 9          | 8          | 39          |
| Pneumatic system | 4          | 2          | 5          | 9          | 9          | 29          |
| Aux power        | 2          | 2          | 6          | 4          | 2          | 16          |
| High voltage     | 1          | 1          | 3          | 2          | 3          | 10          |
| Coupler          | 3          |            | 2          | 0          | 1          | 6           |
| Lighting         |            | 1          |            | 5          | 8          | 14          |
| <b>Totals</b>    | <b>256</b> | <b>285</b> | <b>372</b> | <b>417</b> | <b>429</b> | <b>1759</b> |

Source: Alstom monthly reliability report charts, compiled by Mott MacDonald

**Figure 3.60: Vehicle Reliability - Service Affecting Events - May to Sept 2020**

Vehicle Reliability - Service affecting events

|                  | May       | June      | July      | Aug       | Sep       | Total      |
|------------------|-----------|-----------|-----------|-----------|-----------|------------|
| Traction         | 2         | 4         | 3         | 4         | 10        | 23         |
| Mechanical Brake | 7         | 3         | 9         | 3         |           | 22         |
| On-board Info    | 3         | 5         |           | 2         | 2         | 12         |
| Carbody          |           | 3         | 2         | 3         |           | 8          |
| High voltage     |           | 1         | 4         |           | 1         | 6          |
| Door             | 4         |           |           | 5         | 3         | 12         |
| Coupler          | 3         |           | 1         |           |           | 4          |
| Aux Power        | 2         |           | 1         | 2         |           | 5          |
| Air Supply       |           |           | 3         |           |           | 3          |
| Passenger Doors  |           | 2         |           |           |           | 2          |
| Communication    |           | 2         |           | 3         |           | 5          |
| System           |           |           | 2         |           |           | 2          |
| Air Production   | 1         |           |           | 1         |           | 2          |
| Bogie            |           | 1         |           | 1         |           | 2          |
| HVAC             |           | 1         |           |           |           | 1          |
| <b>Totals</b>    | <b>22</b> | <b>22</b> | <b>25</b> | <b>24</b> | <b>16</b> | <b>109</b> |

Source: Alstom monthly reliability report charts, compiled by Mott MacDonald

Vehicle and System Availability Failure Points presented in Section 2.2.2 this report do not give a complete assessment of the operational and maintenance issues. No Vehicle & System Availability Failures against Warning Notice and Remedial Rights were reported between April and June of 2020 inclusive; however, the Alstom monthly reliability reports indicate 22 service affecting events in both May and June of 2020 (data for April was not made available).

The 22 errors/faults may have been addressed within the rectification times established in the PA, but this data is not available to review. Where data is available, the root cause of these events appears to have not been addressed in the established time frame. Each of these events requires maintenance, and possibly operational resources to troubleshoot and correct.

This report has been developed under a privileged and confidential assignment on behalf of the City of Ottawa. While the report has been prepared for release to City Council as requested by the City and counsel for the City, neither the City nor its' counsel waive privilege over the overall assignment.

### 3.1.3 HVAC

There are vehicle HVAC system items of issue identified in the Project Co Rectification Plan.

One, the operator cab temperature cannot be maintained without the use of supplementary heaters and fans throughout the year. The Rectification Plan indicates that the floor heater relay connections have been repaired, air flow has been increased and improved, and that the heating and cooling setpoints have been adjusted. Supporting design, modification, tracking, nor test documentation have been provided to show the completion of this work, which would render it considered corrected.

Also, the MSC Monthly Reliability Report for January 2021 shows a backlog list of deferred maintenance that indicates several vehicle HVAC units have missing/deferred work related to the smoke detectors. From recent discussions with the City, it is understood the HVAC Smoke detectors become contaminated by dust/dirt particles when changing HVAC filters, resulting in a spares shortage. This has resulted in several smoke detectors being removed from other out-of-service vehicles.

Two, the cab windshield defroster functionality required significant time to clear the windshield for safe operation. The Rectification Plan states: *“details on all the various design enhancements need to be provided to the City in a detailed FMI with all supporting documentation.”* Documentation (supporting design, modification, tracking, or testing reports) have not been received, which would show that this work has been performed and the issue corrected.

### 3.1.4 Vehicle Compressor

The City raised concern with eliminating the second compressor on each vehicle, regarding the impact on vehicle availability and redundancy in the level boarding and sanding systems, both of which require a pneumatic air supply to function. It is common practice for vehicles with a pneumatic air system to have pneumatic connections via the auto-couplers between coupled vehicles within a train consist, to provide redundancy in case of a compressor failure. The removal of the second compressor from each vehicle has removed the main redundancy provision for the pneumatic air system. The Rectification Plan does not identify a corrective measure but does document comments from both the City and Project Co.

- On December 19, 2019, one compressor was removed from 1108 with a pressure sensor faulty (vendor expertise analysis ongoing)
- On December 27, 2019, one compressor was removed from 1127 due to internal leak on the compressor (vendor expertise analysis ongoing)

The Rectification Plan also indicates that the previous proposal to remove every other compressor shall not be progressed until the reliability of the compressor improves. This reliability issue is concerning as the Stage 2 fleet vehicles have been modified in that there is no longer a redundant compressor in each vehicle.

In addition, the plan indicates that in 2018, Alstom completed a modification of “one compressor + air tank” configuration to ensure PA compliance in specific conditions. This change was documented with calculation notes and simulations shared with OLRT and the City. Project Co requests that Alstom needs to deploy this solution on Stage 1 trains to fulfill the requirements. This configuration is part of Stage 2 configuration and has been implemented on the first Stage 2 trains. It states that the air type test report has been provided to the City recently (ADD0000939042-C TS17 Air system report rev C).



Mott MacDonald's review of the deferred maintenance list in the MSC Monthly Reliability Report for January 2021 reveals issues with the vehicle compressor reliability as the items listed below include the removal of at least two compressors for use elsewhere, which would indicate a possible spares shortage:

From Jan 2020 report:

- 60392522 LRV1118 One compressor in fault IOS012. AI 28/01/2020 CAOTT-1118 From April 2020 report:
- 60439515 LRV1125 - B compressor 2020-03-18 CAOTT-1125 From Jan 2021 report:
- 60623357 LRV1143 B Air Compressor Taken CAOTT-1143 2020-11-08
- 60731504 Air compressor 1 missing CAOTT-1135 2021-01-12

Of particular note to this discussion are the following three references from the PA requirements, which are all reliant on there being an adequate air supply to ensure they are fully functional. Noting that 3.25 and 3.28 are specific to ensuring the self levelling air suspension system can maintain the vehicle floor level with the platform to door threshold in order to meet the accessibility requirements. For requirement 3.26 it is necessary to provide an adequate air supply to ensure the vehicle on-board sanding is working effectively, as the sanding system is key to ensuring the service and emergency braking requirements are met, see below:

- OLRT-Scope 5-Schedule 15-2 Part 4, 3.25 Trucks, (d) Truck Components, (ii) *"The secondary suspension shall be controlled by a levelling valve to fulfill AODA/ADA level boarding requirements."*
- OLRT-Scope 5-Schedule 15-2 Part 4, 3.26 Friction Brakes, Track Brakes, (h) Sanding System, (ii) *"The air system powering the sander shall store sufficient compressed air that it is capable of 20 seconds of sand application without running the air compressor"*.
- OLRT-Scope 5-Schedule 15-2 Part 4, 3.28 Interior and Exterior Appointments, (a) General Interior Design, (i) *"The vehicle shall provide level boarding at stations. The entire low floor section shall be ADA/AODA accessible and include longitudinal fixed seats as well"*.

### 3.1.5 Vehicle CCTV

At the time of the issuance of the Project Co Rectification Plan, the wayside CCTV to onboard display system was unreliable and unproven. Alstom mitigated this by placing spotters on the platform to communicate with the vehicle operator. Supporting design, modification, tracking, and/or test documentation has been requested from Project Co; however, none has been provided to show that the proposed software work has been performed and corrected the issue identified by the City.

However, an analysis of the reliability data for this System it would appear there are still issues with the vehicle to station CCTV communication, albeit the occurrences all related to 1109 at the same station location:

From July 2020

- 60515830 LRV 09 -While this train at UOT, CCTV ca CAOTT-1109 2020-07-21

From Oct 2020

- 60515830 LRV 09 -While this train at UOT, CCTV ca CAOTT-1109 2020-07-21

From Jan 2021

- 60515830 LRV 09 -While this train at UOT, CCTV ca CAOTT-1109 2020-07-21

PA reference:

OLRT-Scope 5-Schedule 15-2 Part 4, 3.27 Communication and Passenger Information System, (a) Communication System Functional Requirements, (xiii) Cab Video Display, C. *“The cab video display shall display views of Train doors while the Train is stopped in a Station. A method shall be provided to ensure that the view provided is from the correct platform.”*

Based on the limited data to analysis the reliability of this System it would appear there are still issues with the vehicle to station CCTV communication, albeit the occurrences all related to 1109 at the same station location. As this system does not appear to be meeting the requirements of the PA it is recommended to carryout a more detailed analysis of the system and any proposed mitigation measures to address the situation.

### 3.1.6 Wheel Related Observations

The following sub-sections include observations and comments related to the revenue vehicle wheels from the site visits, derailments, and our ongoing review of the information provided. It is important to note that wheel maintenance is critical to the wheel/rail interface and reducing the risk of derailment, noise and vibration, and track wear/damage. The following areas were recommended for consideration and implementation, if not already being applied.

#### 3.1.6.1 Wheel Flats

Project Co believes that wheel flats were at least in part created by the ATO control software not adjusting to new speed zones quickly enough. It is understood that the software only has a small window of time to adjust the speed of the vehicles entering a new speed zone, failure to reduce the vehicle speed within a set time results in automatic emergency brake application. Project Co also indicated that the EB rate itself is overly aggressive, which is likely contributing to the wheel flats. There have been discussions about possibly reducing the EB deceleration rate, which we recommended that this needs to be carefully considered before any implementation is carried out.

While the data shown in **Figure 3.47: Overview of Emergency Brake events (Overspeed in ATO and Crawlback)** per month illustrates a reduced EB event frequency since July 2020, Mott MacDonald have not been provided with data confirming reduced occurrences of wheel flat events, although it is logical that this would follow. The following commentary reflects continued concern over the likelihood of wheel flats occurring in the event of an EB application.

As no wheel slide control is implemented during an EB, it is very likely that wheel flats will occur. This could be compounded by the sanding system-related issues discussed in Section 3.1.16, as well as potential wheel tread and/or rail head lubricant contamination from the vehicle flange lubrication system creating low friction conditions, which in turn may lead to wheel slide and wheel flats.

The initial use of an incorrect type of sand, subsequently replaced with a type that would appear to be more suitable. We understand suitability has not been verified by the sanding equipment OEM. Additionally, apparent lack of attention to the vehicle on-board sanding system and associated dispensing equipment had raised concerns regarding both the preventative and corrective maintenance processes implemented by Alstom. As this system directly impacts the performance of the traction and braking effort of the vehicle, it is recommended that the rate and magnitude of wheel flats, including the sanding system performance, needs to continually be observed and monitored.

The rate and magnitude of wheel flats needs to continually be observed and monitored, as the high number of wheel truing events to correct wheel flats is likely to result in drastically reduced

wheel life, leading to vehicles being out of service for long periods of time to undergo wheel tire replacements which will ultimately impact on service performance and vehicle availability.

Supporting design, modification, tracking, and/or test documentation have been requested, but not provided. Evidence is required to show that the proposed EB rate change work has been performed and has corrected the issue identified by the City.

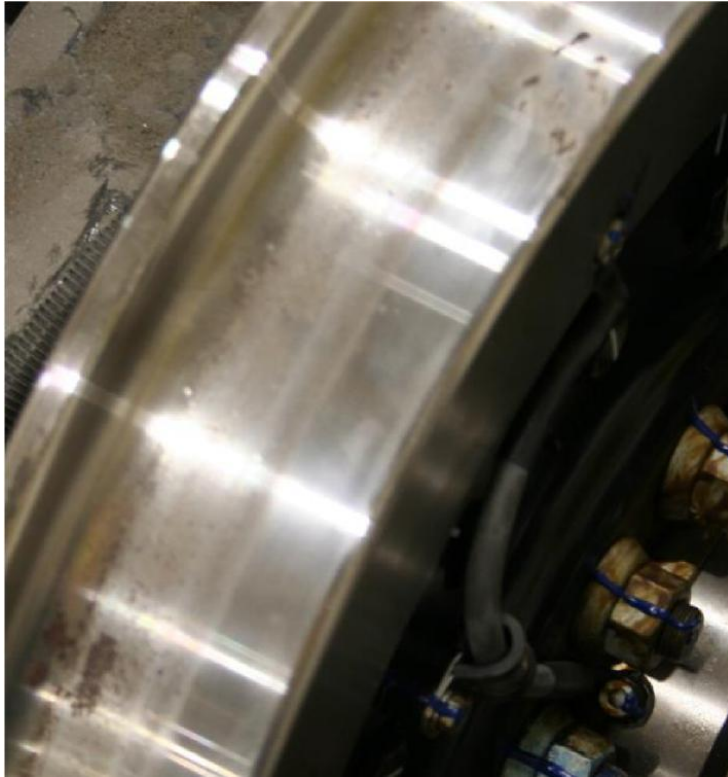
### 3.1.6.2 Wheel Truing

During the on-site inspection, vehicle wheels which had recently been reprofiled on the wheel lathe were observed. The wheel shows coarse machining lines on both the tire tread and flange. This is typically related to the cutting feed and speed settings of the machining process.

**Figure 3.61: Coarse Machining Lines Observed During Site Inspection**



Source: Mott MacDonald site inspection

**Figure 3.62: New Wheel with No Coarse Machining Lines**

Source: Mott MacDonald previous experience

A coarse surface finish increases the potential for the wheel flange climbing against the rail gauge face, potentially causing a derailment. This is especially of concern on the outer rail of a sharp curve and/or switch blade tip.

Of particular note with regards to the coarse wheel profile, are the two in-MSF derailments of 1126 on October 18, 2020, and November 18, 2020. While there are many contributing factors to these derailments, 1126 had just had its wheels re-profiled before the October 18, 2020, incident. Noting that a more recent derailment has occurred in the MSF yard in March 2021 resulting in very serious damage to the vehicle; however, this is still under investigation so its too early to speculate on the potential cause.

Following wheel re-profiling, the tread surface, including flange, should not have a coarse finish. A Good Industry Practice example calls for a surface roughness no coarser than 12.5  $\mu\text{m}$  (N10). This also aligns with the wheel lathe OEM standard. When asked for wheel smoothness measurements, a brochure for the Hegenscheidt Underfloor Wheel Lathe U 2000-150 was provided. The brochure states the surface finish profile as  $R_a \leq 12 \mu\text{m}$ . This indicates that the wheel lathe is capable of a smoother finish. No wheel profile smoothness measurements were provided.

The PA is not specific when it comes to this level of detail; however, Good Industry Practice as provided in the UK Rail Safety and Standards Board GM/GN2497 guidance on requirements for wheel re-profiling state that following re-profiling the tread surface including flanges should be free of visible defects such as cracks, cavities, flats or spalling and have a surface roughness no coarser than 12.5  $\mu\text{m}$  (N10), which also aligns with the wheel lathe OEM standard.

### 3.1.6.3 Wheel Wear Recording

As a reply to a request for wheel measurement data, 1920 single page automatically generated measurements from the Hegenscheidt wheel true machine were provided. Each sheet contains the pre and post wheel true data for a single axle, as well as identification data associated with that axle.

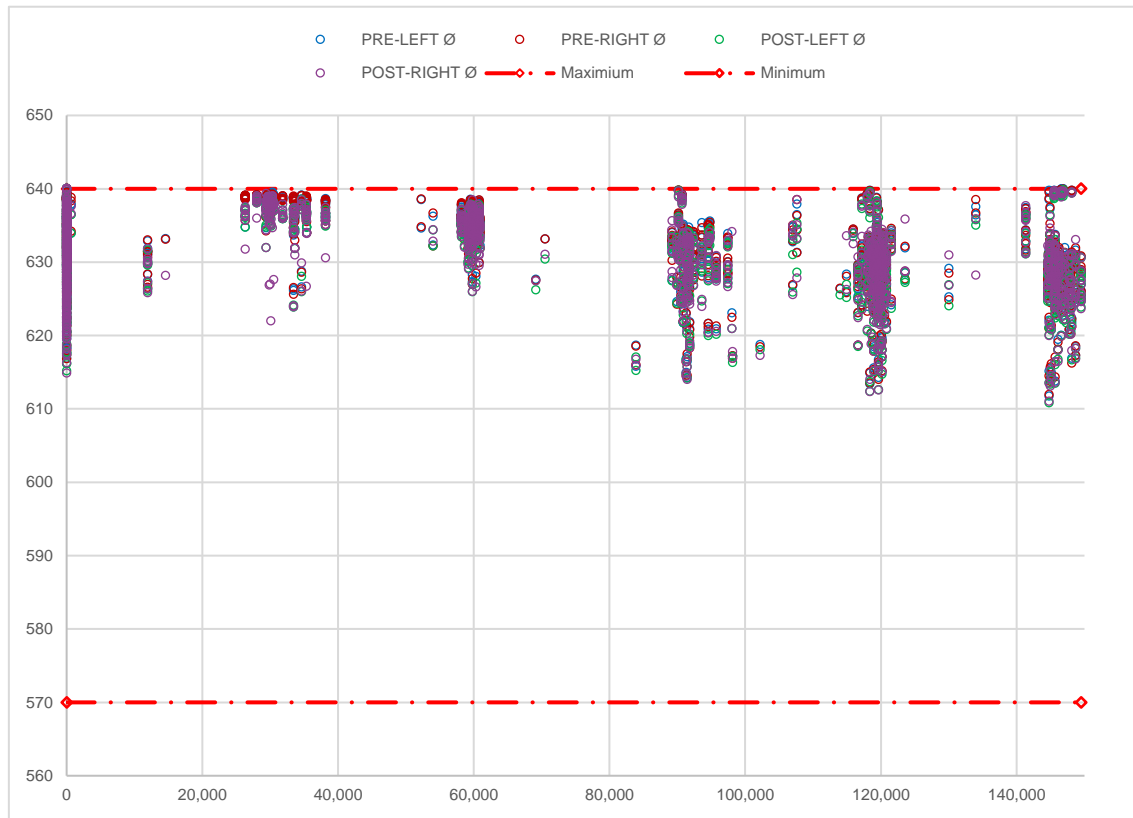
The data from these measurement sheets should inform the preventive maintenance activities for the axle, truck, vehicle and in some cases the entire vehicle fleet. Taking the data set as a whole, there are some concerning observations:

- Out of the 1920 measurement sets, 741 entries have a mileage recorded as 0. There are multiple examples of different mileage entries on a single day for a single vehicle, some of which may be zero. Without correct mileage data, it is difficult to identify trends, outliers, and to utilize this data as a predictive tool.
- The reason for machining field is always filled with “nb.” Without this type of context, it is not clear if the wheel truing process is due to a regularly scheduled maintenance process, addressing wheel flats, hollowing, flange wear, or diameter matching across a truck. This type of data could be utilized to sort the data produced by the Hegenscheidt.
- Vehicles 1135 and 1136 have no data entries, even though there is data for 1137, 1138, 1139 and 1140.
- Vehicle ID and wheelset ID are most often entered as the same (vehicle number). The wheelset position records the axle position on the vehicle. The truck ID appears to be the truck location on the vehicle. Other North American maintenance facilities record the axle and truck serial numbers in the wheelset ID and truck ID fields respectively. This method of utilizing serial numbers allows tracking of data on specific axles and truck over their entire service life regardless of the vehicle or truck they are installed on with the data in its current form, the traceability is lost as soon as the truck is removed from the vehicle.

The wheel diameter data illustrated in **Figure 3.63** below shows clusters of data sets around regular mileage thresholds, with no wheels near the minimum diameter yet. The chart illustrates the magnitude of zero mile entries as mentioned above.



**Figure 3.63: Chart of Wheel Diameter Pre and Post Wheel True**



Source: Supplied file "entire wheel profile History-Dec 11 -2020.pdf"

The back-to-back measurement is a measurement of how far apart the two wheels on an axle are from each other. This is a key data point, as this controls where the wheels interface with the rail gauge face and safe passage through special trackwork without risk of potential derailment. The data shows a cluster of data points around 30,000km, but none after. This is a good indication that corrective measures were taken; however, it does raise the concern of how long those vehicles ran with an out of tolerance back-to-back measurement. It is possible that these vehicles were delivered in this state. Noting that back-to-back dimensions are critical to wheelset guidance through switches and interaction with restraining and guard rails.

It is important to note that following the two mainline vehicle derailments in August and September 2021, the measurement of wheelset back-to-back dimensions has been identified by ALSTOM as being an accurate means of measuring and monitoring these key dimensions to assist in early detection of potential wheel bearing deterioration leading to failure. ALSTOM specifically stated in their report that this method would have detected the wheel bearing anomaly on 1119 before derailment if it had been implemented. However, while this measurement is currently carried out using the integral function of the wheel lathe to measure and record the wheel back-to-back dimensions, ALSTOM have identified that accuracy would be improved by the use of a dedicated back-to-back measurement tool that can be used in the pit with higher frequency. This would also help to validate the accuracy of the current wheel lathe measuring system to ensure repeatability can be obtained. The ALSTOM report also identified the need to ensure wheelset measurements need to be properly tracked by bogie serial number and not just by current train location, this statement further backs up our previously discussed concerns about the apparent lack of configuration control by the

maintenance team. Noting that this is essential for effective asset management control in order to ensure the asset and its condition is tracked throughout its complete life cycle.

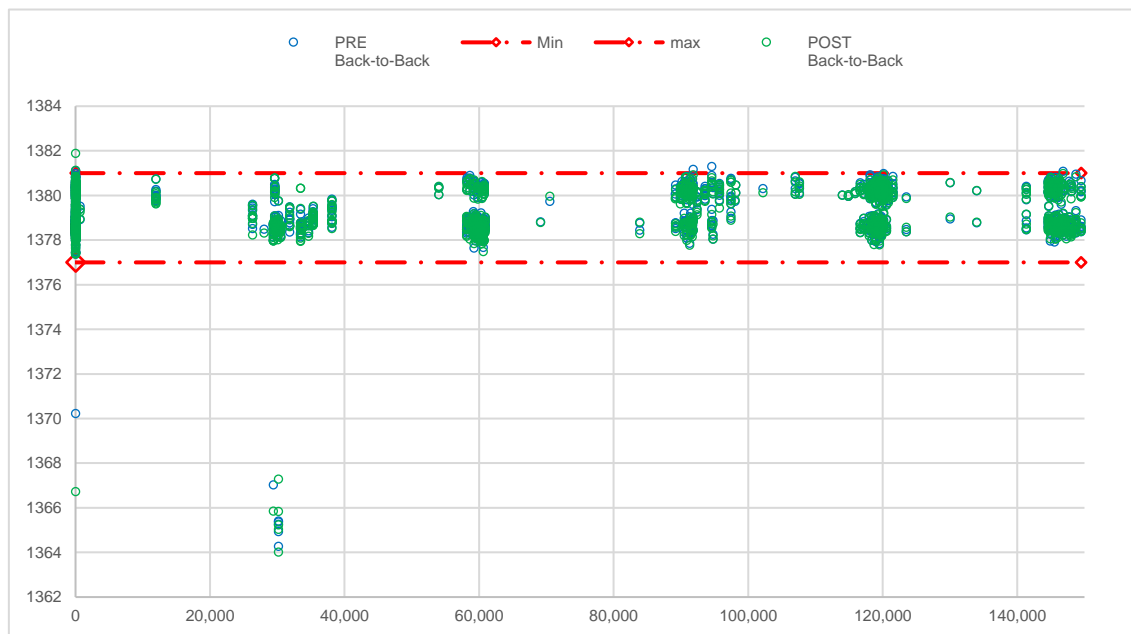
It is recommended to carry out a sample validation of the wheel diameters against what the wheel lathe is currently producing, as a review of the wheel truing records shows several anomalies. Diameter difference between wheels on the same axle and between axles on the same truck are critical for not only ride and curving performance, but also for the ATO system as wheel diameters must be kept within tolerance to ensure correct speed sensing of the vehicle/wheel speeds. Failure to maintain these within OEM tolerances may lead to spurious speed signals and possible EB applications.

The profiles of wheels on the same axle should be aligned relative to each other, any misalignment of one profile relative to the other will affect wheelset conicity, and hence stability and curving performance. Noting that truck/wheelset curving performance could contribute to rail corrugations. It is recommended to carry out a wheel profile validation check against what is being produced by the wheel lathe, including the hand measuring gauges used post wheel truing and for routine maintenance.

Wheel back-to-back dimension validation checks against what the wheel lathe is measuring should be carried out on a sample number of trucks/vehicles (e.g., 10%). The checks should include at least three equally distanced measurements around the back face of the wheel.

Wheel flange and tread profiles and wheel diameters should be carefully managed, and wheel wear measuring and recorded carefully, including knowing the current wheel flange height/thickness (new/worn), tread wear/hollowing, and wheel diameter limits, as any misalignment of one profile, including out of tolerance wheel diameters relative to the other, will affect wheelset conicity, and hence stability and curving performance. The tread, when newly profiled, needs to comply with the requirements set out in the respective standard, for example BS 5892, Parts 3 and 6, EN13260 and AAR Manual of Standards and Recommended Practices. It is recommended to validate the wheel flange and tread profiles, and wheel diameters are being maintained in accordance with the relevant standards and Good Industry Practice.

**Figure 3.64: Chart of Back-to-Back Measurements Pre and Post Wheel True**



This report has been developed under a privileged and confidential assignment on behalf of the City of Ottawa. While the report has been prepared for release to City Council as requested by the City and counsel for the City, neither the City nor its' counsel waive privilege over the overall assignment.

Source: Supplied file "entire wheel profile History-Dec 11 -2020.pdf"

### 3.1.7 Wheel Flange Lubrication System

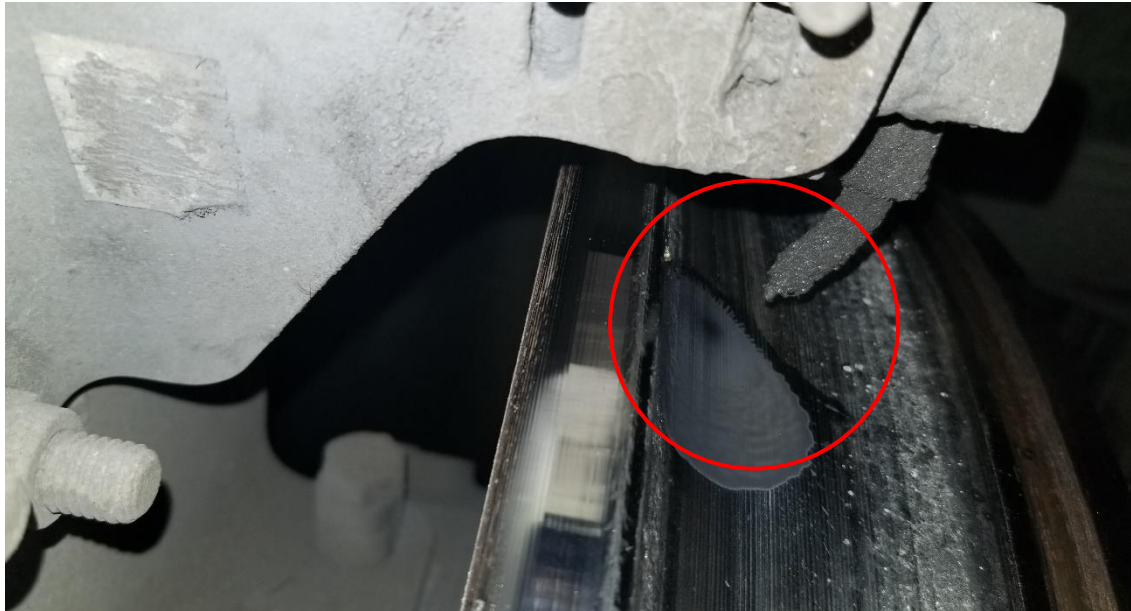
During the on-site visit, it was possible to inspect the on-board wheel flange lubrication system on a sample vehicle. There is only one truck/bogie (LCC1) out of the five installed on each vehicle that is fitted with this system, which includes four lubricant spray nozzles (one for each wheel). While inspecting the equipment, we noticed that one of the four nozzles was missing (see **Figure 3.65**), which would mean the adjacent wheel flange does not receive any lubricant. The missing spray nozzle may result in lubricant leaking onto the running rail surface during the operation of the lubrication system, which is automatically operated on a pre-set timing basis. This could lead to the oil being spread along the rail head by the passing wheels and potentially creating slip/slide conditions for not only this vehicle but others that follow.

**Figure 3.65: Missing Flange Lubrication Spray Nozzle**



Source: Mott MacDonald site inspection

It is important to note that the gap clearance setting between each spray nozzle and the wheel flange is critical in ensuring the lubricant is ejected at the correct angle to ensure the flange is lubricated correctly. Otherwise, the amount of lubricant either does not contact the correct area of the flange or it sprays onto the wheel tread, which is likely to result in the wheel transferring the lubricant onto the rail surface (see **Figure 3.66**). This compromises the friction on the wheel tread, leading to wheel slip/slide situations and inherently prevents the lubrication intended for the wheel flanges from being transferred/applied to the gauge face of the rail.

**Figure 3.66: Incorrectly Set Flange Lubrication Spray Nozzle**

Source: Mott MacDonald site inspection

Maintenance staff indicated that the lubricant reservoirs are “topped up” every two months or so even though reservoir is small. The on-board lubricant reservoir needs to be monitored to determine usage to determine the maintenance intervention timescales, as it is not recommended to run between maintenance intervals with no lubricant being applied otherwise the flange/rail conditioning will be lost, which may result in having increased rail/rail wear and potential noise.

A one-off check and correction adjustment of the flange lube nozzles, in accordance with the OEM requirements, should be completed across the fleet now, and, subsequently, checks should be carried out to confirm the correct alignment of the flange lubricator spray nozzles after all wheel reprofiling/changing is completed, due to the wheel diameters being reduced/increased. We note that numerous vehicles have undergone wheel truing over the last year to remove wheel flats, which could mean that many spray nozzles are incorrectly aligned. In addition to a one-off fleet check, we recommended ensuring that the correct OEM requirements and any special tooling are available to the Project Co maintenance staff, and ensure that the Project Co maintenance staff have undergone the correct level of training to carry out the adjustments.

### 3.1.8 Abnormal Pantograph Carbon Wear/Damage

The Rectification Plan identifies the significant groove patterns in the pantograph carbons as a symptom of poor OCS stagger. The Rectification Plan states the mitigation for these groove pattern as: *“Replace heavily grooved Carbon strips. Remove Bronze “sliders” (winter season coming to an end). Continue preventative maintenance to ensure Pantograph spring tension is set correctly.”* The solution proposal is *“Project Co to ensure that the OCS is within the maintenance tolerances as identified within the O&M manual provided by OLRTC.”* The OCS stagger itself is addressed in Section 3.2.1.5 of this report. This section will focus on the pantograph itself.

One of the mitigation items specifically mentions ensuring the pantograph spring tension or contact force is set correctly. During an on-site visit, the process of measuring and adjusting the pantograph contact force was observed.

**Figure 3.67: Current Project Co. Pantograph Force Check**



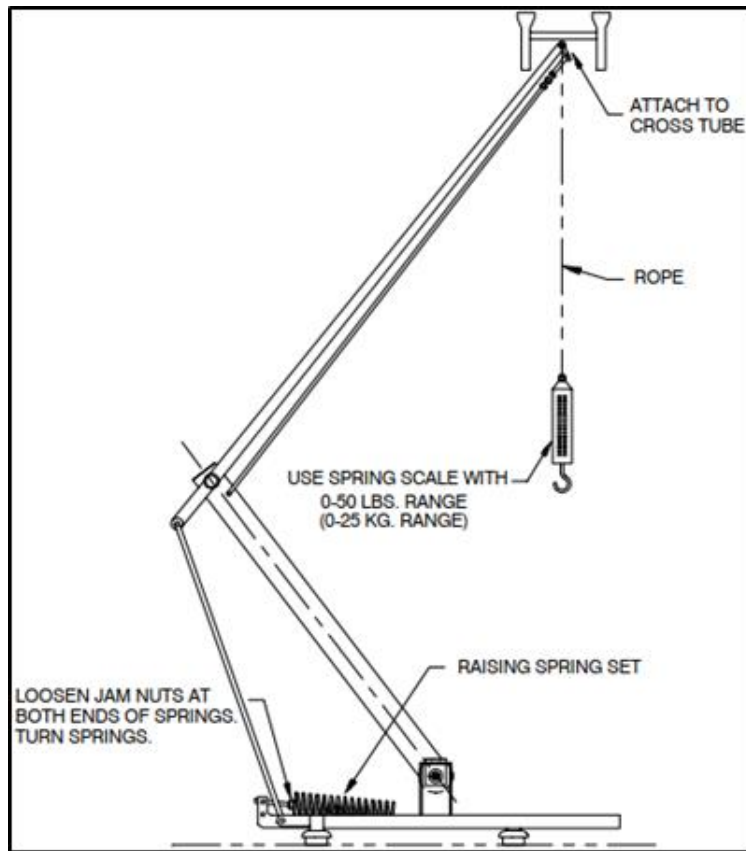
Source: Mott MacDonald site inspection

The process includes the use of a tool bag with 23 lbs of weight hung from the pantograph head, and pantograph position checks were observed at three positions: low, medium, and high. The spring pressure was adjusted until the pantograph head stayed stationary. This weight value and upward force checking process could not be validated against the OEM requirements.

This process does not measure the upward force exerted on the pantograph head and does not create any data to allow for traceability on how often a specific pantograph has been adjusted, where it sits within the tolerance range (e.g., +/-10%), how long it has run since installation, or the magnitude of any adjustments made. Without this data, there can be no quantifiable trends to measure any changes made to the vehicle, pantograph, or OCS.

The procedure adopted by Alstom does not align with typical OEM maintenance requirements, and therefore the actual force setting cannot be assured. A copy of the OEM maintenance procedure was requested but has not been provided.



**Figure 3.68: Example of Pantograph Contact Force Check**

Source: TRANSTECH – generic arrangement

The other mitigation item of note is the replacement of heavily grooved carbon strips. Alstom has been replacing the heavily worn or cracked pantograph carbons. From discussions with the City, it is understood that after OCS adjustments, carbons have been replaced due to cracking damage rather than wear. This is an indication that there is still improvement to be made on the OCS system, as described earlier in this report. This cracking damage may also be hiding the true extent of carbon wear. Details on pantograph carbon mileage/life have been requested but has not been provided. Without this change interval data, the trend tracking element of preventative maintenance is not possible. Similarly, this data would provide a measurable quantitative measurement of improvement of any OCS adjustments or improvements.

Recommendations in this regard are included in Section 5 of this Volume. The recommended processes are intended to create the necessary data to provide traceability and continuity on how often a specific pantograph has been adjusted, how long it has run, and the magnitude of any adjustments and carbon replacements have been made. Without this data, there can be no quantifiable trends to measure any changes made to the vehicle, pantograph, or OCS. These processes should be continued until such time the issues have been reduced/eliminated to an acceptable level of risk. In some cases, it would be prudent to adopt some or all of the above as Good Industry Practice in maintenance, and to be incorporated into the current maintenance requirements.

### 3.1.9 Line Inductor (Roof Flashovers)

#### 3.1.9.1 Introduction to Line Inductor failures

From the commencement of service, there have been multiple failures with the Alstom Citadis Spirit LRVs. The types of failures have been consistent for all units, with the line inductor being identified as one of the main root causes, with a flashover from the windings to ground. The flashovers occur over the insulated surface of the inductor support structure. Although this failure is consistent, the location of the flashover arc varies slightly between different units.

The impact of the line inductor flashovers is causing other systems to fail, such as:

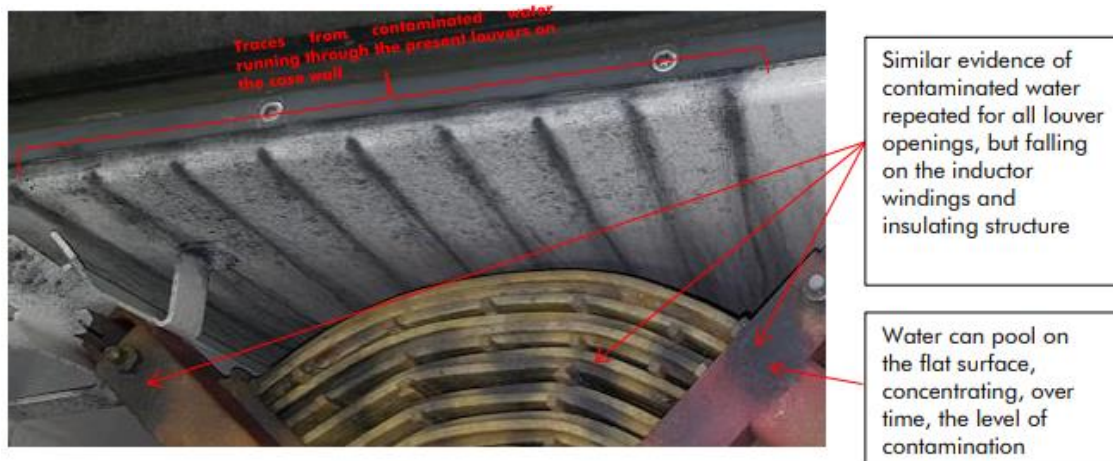
- Line contactor tips to Kiss Weld together
- High Speed Circuit Breaker (HSCB) to lock open
- Auxiliary Power Supply (APS) failure

#### 3.1.9.2 Environmental impact of line inductor failure

Due to the line inductor's current design, it has been made evident from previous failure reports, that environmental contaminants are the root cause of failure, such as:

- Pantograph carbon dust deposits
- Copper particles from the OCS
- Salt used from de-icing the roads on over-bridges
- Water ingress

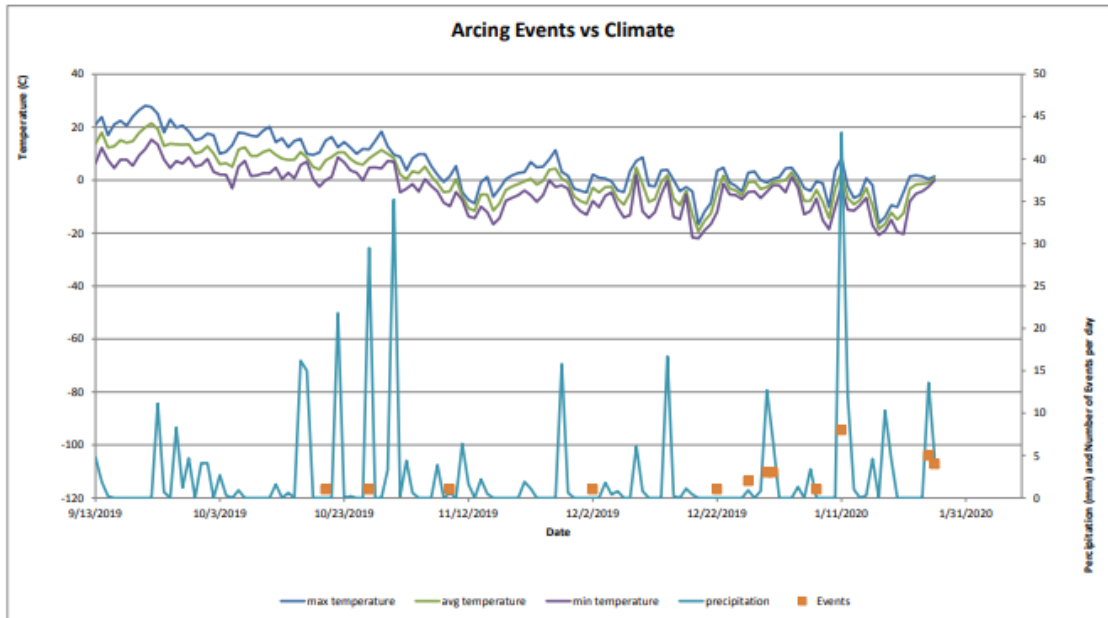
**Figure 3.69: Inductor Compartment of a Typical Traction Case, After 75000 km**



Source: Alstom

According to the line inductor failure reports, peaks in failures tend to occur in late December / early January, on days with precipitation and when the temperature is just above 0°C. This is shown in figure below. This implies that failures are most common on rainy and/or freezing rain and/or wet snow mix. On days below 0°C when it is snowing without precipitation, there are no reports of failures. Snow, while it may enter the present louvered ventilation cover design in small quantities, will largely blow off the top of the cover due to train motion. Rain, however, can flow across the surface of the cover, run directly in the louvers in concentrated streams and carry contaminants with it. This is illustrated in the chart below.

**Figure 3.70: Arcing Events vs Climate**



Source: Alstom

**3.1.9.3 Line Inductor quality defects**

Alstom has submitted a Failure analysis report, *LINE INDUCTOR DTR0000377985 Doc # AYD0000561716*, that makes a performance comparison between a failed line inductor (serial number 169) with a prototype (B1841 – AY00000206364), received in 2015.

Alstom have identified quality issues within the insulation impregnation process. Below illustrates the difference between the prototype (B1841 – AY00000206364) and the failed line inductor (serial number 169).

**Figure 3.71: On the Left the Prototype; On the Right Serial Number 169**



1.

Source: Alstom

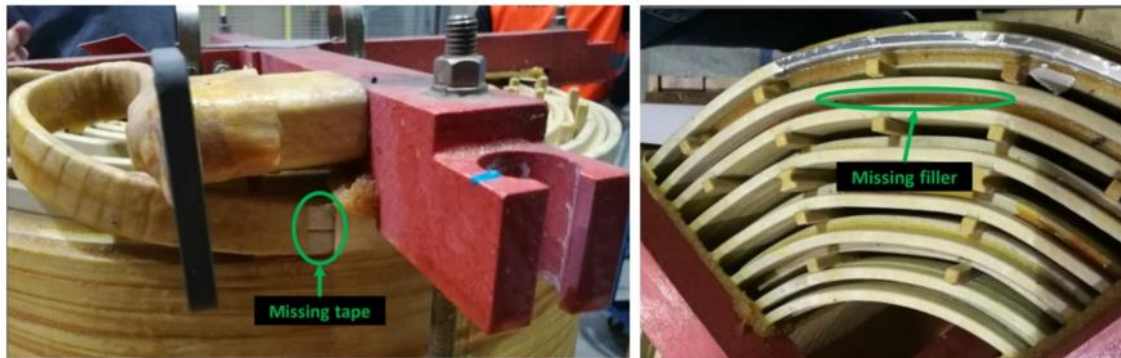
On each conductor (serial number 169) there was a single, non-overlapped layer of Nomex. This is a quality issue, as two layers of Nomex should be applied when constructed.

This report has been developed under a privileged and confidential assignment on behalf of the City of Ottawa. While the report has been prepared for release to City Council as requested by the City and counsel for the City, neither the City nor its' counsel waive privilege over the overall assignment.

**Figure 3.72: Serial number 169: Single Layer of Nomex on the Individual Conductors**

Source: Alstom

Tape and filler are not present. Filler is used to avoid accumulation of dust and contamination between the turns.

**Figure 3.73: Serial Number 169: Missing Tape and Filler**

Source: Alstom

#### 3.1.9.4 Alstom's proposed mitigation

Alstom's *Line Inductor Failure Analysis Report, Doc # DED0000 Rev A*, states the three planned mitigation stages: immediate, short term, and final solution mitigation.

##### **Immediate mitigation:**

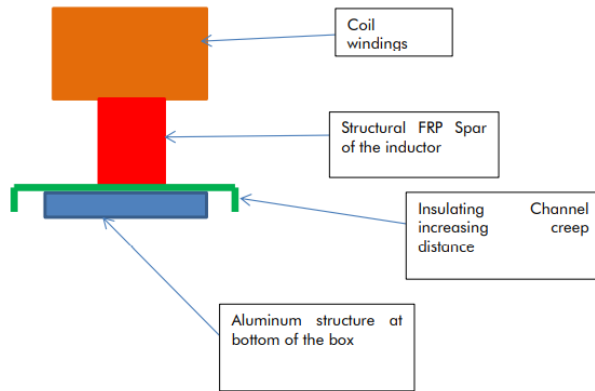
- Develop a plan to clean the inductors, to remove all the contamination.
- To coat areas where the line inductor has lost its moulded surface finish with GE Glyptol insulating paint.
- Obtain spare inductors from Hornell to replace only the inductors.
- Repaint the interior of the inductor compartment with primer plus GR Glyptol to cover any of the spots where the arc has shorted against the case.
- Block off the louvers covering the structural part to prevent water from running on the most sensitive parts of the inductor as identified in the root cause.

##### **Short-term mitigation:** Case modifications to improve creepage distance/environment

This report has been developed under a privileged and confidential assignment on behalf of the City of Ottawa. While the report has been prepared for release to City Council as requested by the City and counsel for the City, neither the City nor its' counsel waive privilege over the overall assignment.

A proposed priority mitigation and potentially part of the final solution could be envisioned to cover the aluminum cross at the bottom of the inductor enclosure with a fibre-reinforced polymer extruded channel to increase the creepage distance below the inductor on a horizontal plane. The mounting of this channel would be as below viewed from the end of one of the structural spars of the inductor.

**Figure 3.74: Proposed Short-Term Mitigation**



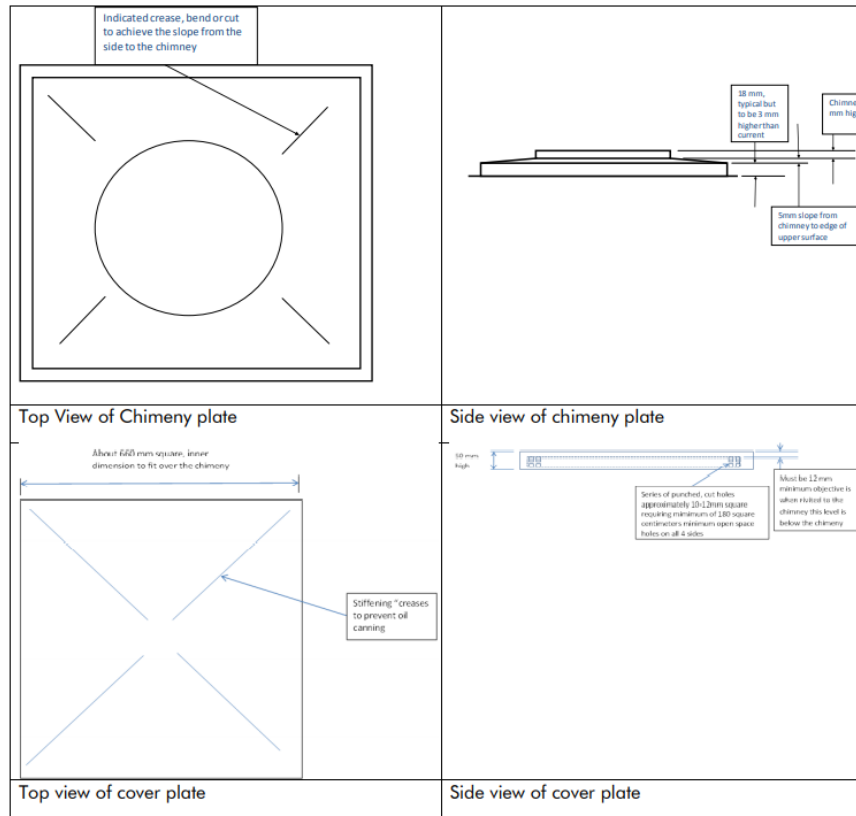
Source: Alstom

#### Proposed case modifications to improve the environment:

- A means to prevent water from directly pouring into the enclosure: the louvered slots should be removed from the cover and replaced with a chimney approximately 10mm high to prevent water flowing into the ventilation openings.
- The chimney should be mounted on a plate with approximately 5mm slope between the edge of the chimney and the edge of the plate to allow any water that gets on that surface to flow off the edge.
- A new cover with a raised shield to prevent rainwater and falling pollution from entering the chimney openings directly.
- The clearance between the rain shield and the chimney needs to be sufficient to provide more than 180cm<sup>2</sup> of area around the circumference (the same total area of the present louvers) for cooling.
- The rain cover requires a grid to prevent ingestion of leaves etc. The grid requires the same minimum 180cm<sup>2</sup> for cooling.



**Figure 3.75: Proposed Case Modifications to Improve the Environment**



Source: Alstom

**Final solution mitigation:**

Alstom state that the final solution largely concentrates on improvements to the line inductor itself. These improvements are to be considered in addition to the short-term solution, specifically that in the long term, the final solution will be a combination of the short-term solution and the improvement in the inductor environment, plus improvements to the inductor itself. The basis of these improvements is as follows:

- There is an identified need to reassess the minimum creep distances, and how these distances are achieved
- Followed up with modifications to the existing design to meet or exceed the revisited creep and strike requirements, with the minimum impact to the fundamental design, so that any changes can be put in place quickly, easily and without requiring modifications to interfaces (plug and play)

Proposed changes to the inductor are as follows:

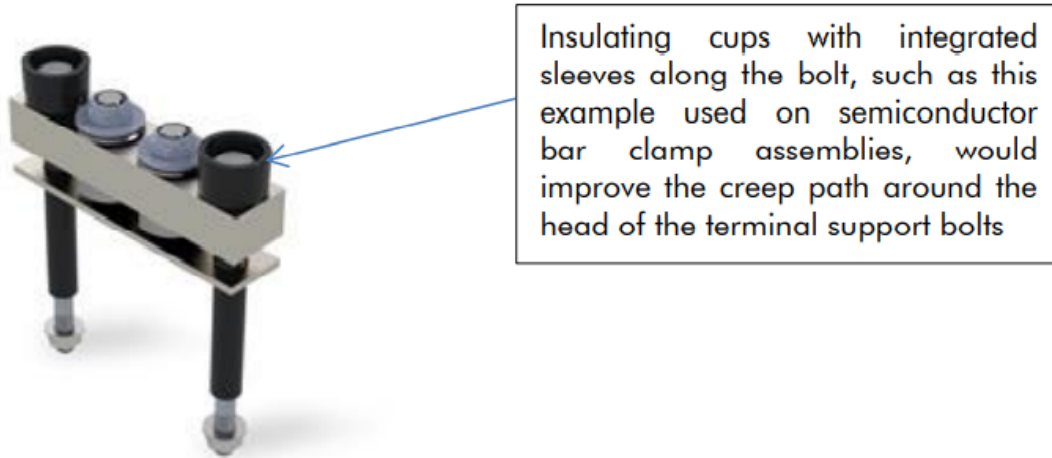
- Better control of the top terminal taping
- Increase the creepage distance around the bolts supporting the terminals – increased creepage distance to the plate at the mounting foot
- A review of the resin used for the impregnation of the windings and its susceptibility of surface tracking due to arc discharge activity

Alstom states that each of the proposals have been based upon maintaining as much of the existing design as possible to eliminate redesign of the windings themselves or requalify the structural elements.

This report has been developed under a privileged and confidential assignment on behalf of the City of Ottawa. While the report has been prepared for release to City Council as requested by the City and counsel for the City, neither the City nor its' counsel waive privilege over the overall assignment.

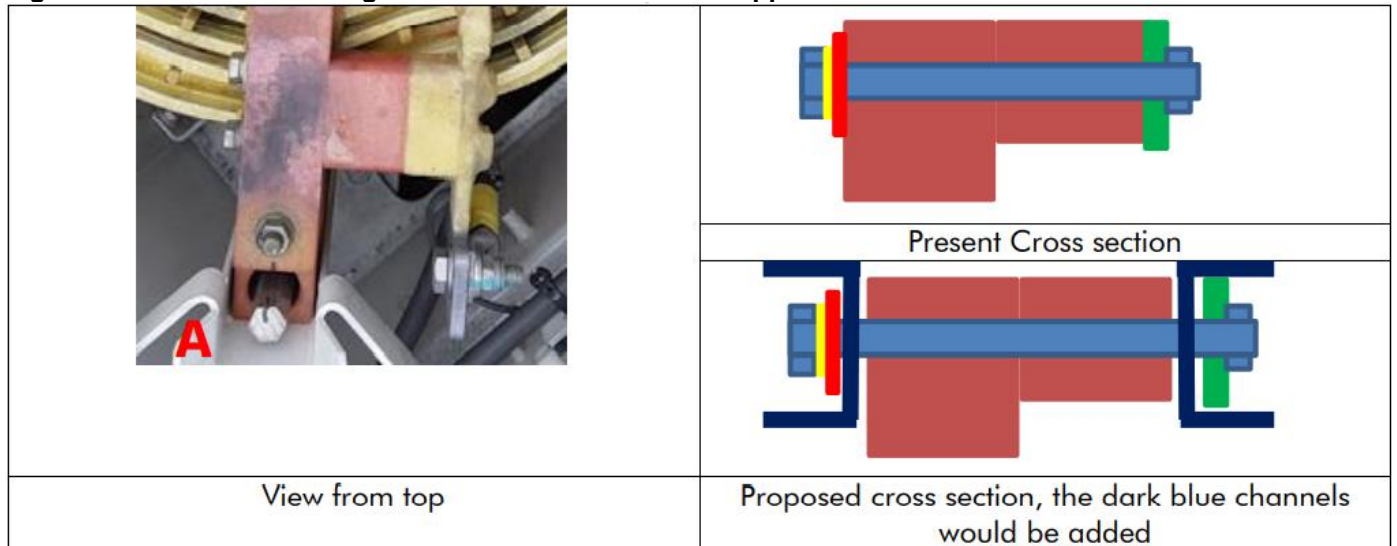
Alstom states that qualification of the improvements in terms of the arcing/discharge activity require some review as the original design passed all the requirements for IEC-60310.

**Figure 3.76: Use of Insulating Cups on the Terminal Support Bolts**



Source: Alstom

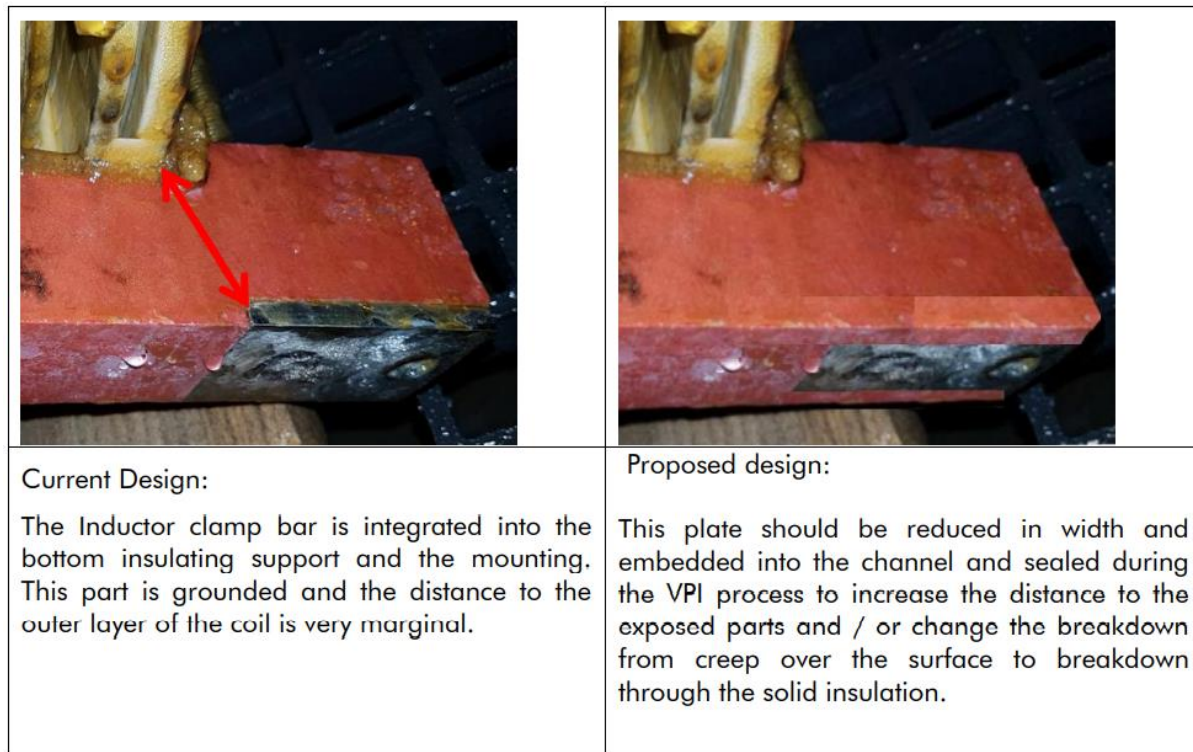
**Figure 3.77: Use of Insulating Channels on the Terminal Support Bolts.**



Source: Alstom

Still to be addressed is the clamping assembly of the inductor, with current design and proposed modifications illustrated and discussed below. Alstom state that this has been seen in some cases to have been the end of the tracking path from the windings to the chassis.

**Figure 3.78: Proposed Creep Distance Improvement**



Source: Alstom

According to the table below taken from the *Project Co Confederation Rectification Plan* dated 01 February 2021, eight LRVs had undergone the rework of the line inductors, with February 2021 being the planned date for the rest of the fleet to be completed. The *Project Co Confederation Line Major Issue Plan* is intended to identify the problem, identify the initial cause of the problem, propose a solution and what's been achieved to date with the planned end date. Although this has been provided, there has been very little to no information regarding the outcome/results of the issues discussed within the major issue plan.

**Figure 3.79: Line Inductor Major Issue Plan – From Project Co Rectification Plan**

| Problem  | Cause   | Solution identified   | Achieved to date | End date | R | Y | G | Comments  |
|--|---|---|------------------|----------|---|---|---|---|
| Rooftop flashovers of line inductors, caused by winter brine contamination of inductor. Line contactor welding caused by high current. OCS tripping and affecting service. | Cracks in inductor encapsulation allowing electrolytic conduction to earth when water/ brine enters inductor compartment. | Rework of line inductor with improved design and process. Revised line inductor on target, delivery and installation June-2020  | 8 SUs completed  | Feb-21   |   |   |   | 7/39 SUs completed  |
|  | Lack of detection of the fault causes eventual contactor welding  | Review of propulsion logic to detect when there is a combination of undervoltage and overcurrent and provide appropriate isolation of inverter New line contactor revision as well as pre charge contactor management proposal 4/22 |                  | May-21   |   |   |   | Retrofit to be scheduled with Line inductor                 |
|  | Failure of 2 LRV trains because of single HCSB opening  | Fix to TCMS software to permit movement with single HSCB opening. Change request has been tested and validated. Evaluation of the results of the global software. Development of software subjected of the successful validation    | 36xSU            | Aug-20   |   |   |   | TCMS (1.2.5.12) Validation Completed , Deployment on Going. |

Source: The City

**3.1.9.5 Line Inductor overview**

Although Alstom have released the requested documentation for the following:

- *Line Inductor Failure Analysis Report, Doc # DED0000 Rev A*

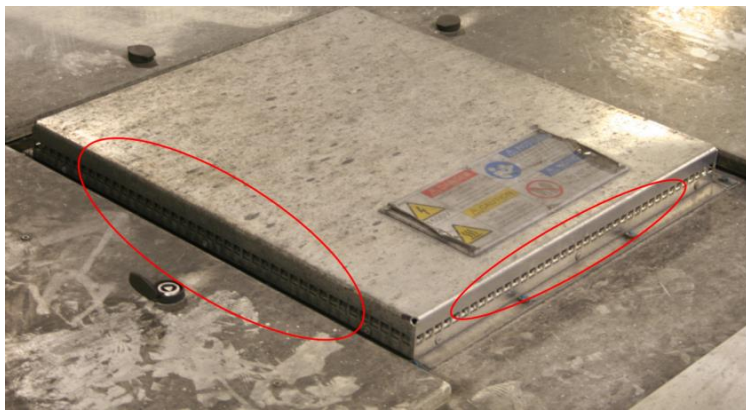
This report has been developed under a privileged and confidential assignment on behalf of the City of Ottawa. While the report has been prepared for release to City Council as requested by the City and counsel for the City, neither the City nor its' counsel waive privilege over the overall assignment.

- Failure analysis report, LINE INDUCTOR DTR0000377985 Doc # AYD0000561716

These documents contain information regarding the next steps for mitigation, although they have not confirmed if the small ventilation holes on the new type of line inductor cover could provide sufficient ventilation to the inductors, especially if the holes became blocked by snow, leaves or other contaminants. Should the airflow be restricted, this could lead to potential overheating and deterioration of the line inductors insulation and result in more short circuit/flashovers.

Since these modifications were implemented, and despite requests, there has been no evidence/documentation to demonstrate there is adequate airflow passing through the ventilation holes /temperature of the inductors or use of testing equipment such as: anemometer for air flow, or thermometer for temperature.

**Figure 3.80: New Line Inductor Cover**

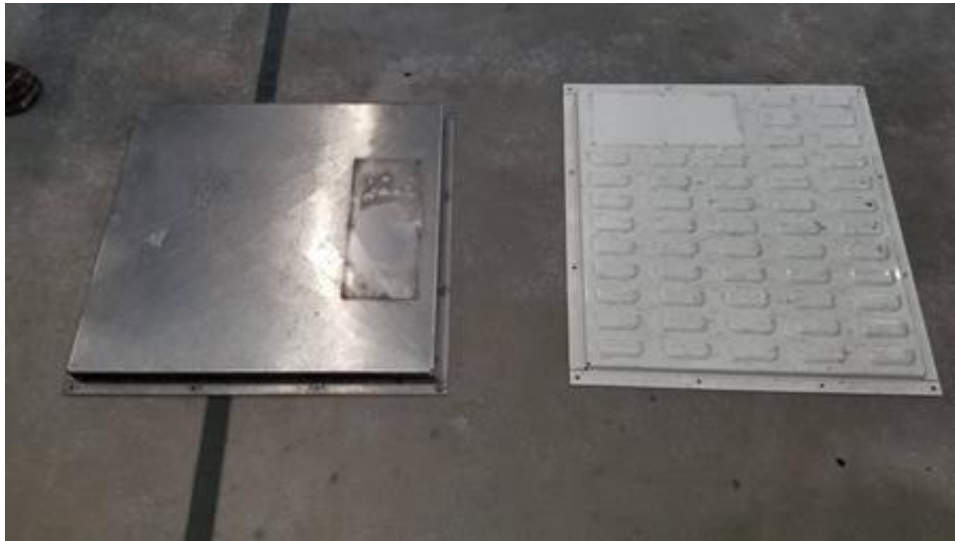


Source: Mott MacDonald site inspection

Each LRV has three roof-mounted traction converters, one for each power truck, one near each end of the vehicle (LMC1 & LMC2), and one located in the centre of the vehicle near the pantograph (IMC1), this is illustrated below. The centre traction converter (IMC1) will potentially be exposed to the carbon dust from the pantograph. There has been no apparent analysis from Alstom to determine if there have been any specific trends to the location of the line inductor failures, i.e., have failures occurred in all three locations. For any analysis it would be expected that the traction converter location would have been considered in order to determine if the pantograph carbon dust contamination is a significant factor in the inductor failures.

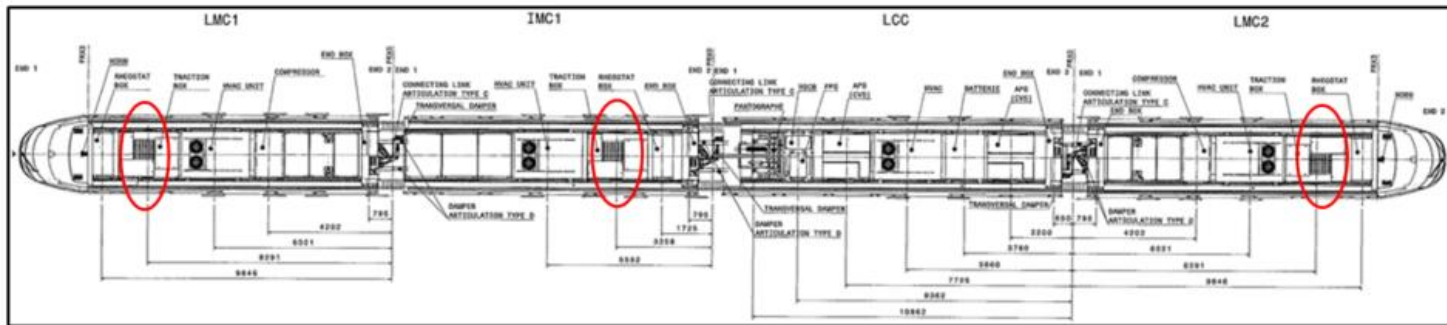
However, while the Alstom report identifies the environmental elements as being the root cause of failure, what the report fails to consider is if the manufacturing defects found with the inductors would have suffered the same failures if they had been manufactured to the design standard for this application. Noting that the insulation coating of the inductor windings would typically be designed to withstand water/moisture ingress.

**Figure 3.81: New (Left) and Original (Right) Line Inductor Ventilation Covers**



Source: Mott MacDonald

**Figure 3.82: Roof-Mounted Traction Converter Diagram Showing Line Inductor/Ventilation Cover Locations**



Source: Alstom

**3.1.10 Configuration Management**

During the pre-shipment inspection at Alstom’s Brampton facility on March 16, 2021, it was observed by Mott MacDonald’s Resident Vehicle Inspector that it appeared that previously used traction converters from revenue vehicles have been installed on 1152, see Figure 3.83 below. Noting that other subsequent new LRVs have also been observed with used equipment mounted on them.



**Figure 3.83: Previously Used Traction Converter Installed on LRV1152**

Source: Mott MacDonald

This assumption is based on the fact that the line inductor ventilation cover shown above is of the original design, with the ventilation openings on the top of the cover (**Figure 3.83**). As previously discussed, the revenue fleet has been undergoing a modification/rectification program since mid 2020 to replace the cover and to rework/replace the inductors as part of the Rectification Plan. Following this finding, Mott MacDonald have since carried out a close inspection of the photographs taken from previous pre-shipment inspections of 1149, 1157 and 1151, this has identified that in addition to 1152, discussed previously above, the other three vehicles also had the original design of cover fitted. These observations are rather discerning as they demonstrate a lack of configuration control between what has been implemented by Project Co on the revenue vehicles and what is being supplied by Alstom on the new vehicles being manufactured at their Brampton facility.

Without further investigation, it is unknown whether the modifications/rectification work identified in the Rectification Plan has also been carried out to each of the line inductor units. Therefore, there is a risk of reintroducing equipment into the Ottawa fleet that has the potential to fail in service, as encountered previously. Also, if our assumption is correct and the traction converters identified, with the original design covers, have been previously removed from revenue vehicles due to earlier in-service failure/faults then there is a further potential risk of repetitive problems being reintroduced into the fleet. Without a robust configuration management system in place to provide the necessary control and traceability of previous faults/repairs/modification status there is a likelihood the fleet and ultimately the passenger service will suffer both in the short/long term.

To add further concern about configuration concerns, it was also noted during the pre-shipping vehicle inspections that the high voltage warning tag plate installed on the ventilation cover, indicates 750V instead of the 1500V used for the Ottawa vehicle (**Figure 3.84**). In this case the configuration issue also presents a safety concern related to mislabeling of an electrical component.

**Figure 3.84: Propulsion Converter Indicating the Wrong Voltage and Using the Old-Style Line Inductor Cover**



Source: Mott MacDonald site inspection

### 3.1.11 Line Contactor

#### 3.1.11.1 Introduction to Line Contactor failure

Alstom has identified within the *Line Inductor Failure Analysis Report, Doc # DED0000 Rev A*, that the impact of a line inductor failure is causing other faults, such as, the line contactor tips to weld together (kiss welding), due to repetitive operation under fault load conditions and overcurrent resulting in a “line conductor stuck closed” fault.

#### 3.1.11.2 Proposed Line Contactor mitigation

Mechanical modifications to the line contactor have been detailed in an RFI (RFI-P)-ALS-1111, which was shared by Alstom with the City in February 2020. Although previously requested, no documentation of type testing or qualification testing has been confirmed to validate these modifications have been made or provided a type/qualification test report. Alstom have identified that the successful mitigation of the line inductor flash over events will eliminate this occurrence from happening.

### 3.1.12 Auxiliary Converter (APS)

#### 3.1.12.1 Introduction to Auxiliary Converter failures

From December 2020 to January 2021, the Alstom reliability reports indicated a drop in the number of reported services affecting APS failures. However, this did not reflect what was being seen in the Maintainability Reliability report for Jan 2021: in section 2.5 Backlog of Deferred Maintenance, there are several APS-related items including removed/missing units from stopped vehicles, assumed to keep the fleet operational. Also, Mott MacDonald’s observations in Brampton where the Phase 2 LRVs are being produced identified several defective APS units taken from revenue vehicles undergoing on-site repairs, and new vehicles being fitted with reused/repaired units. The root cause of the APS failures is still unconfirmed, but based on the nature of the failed APS components seen, it’s clear that internal electronic components are failing with serious damage from possible overload/temperature related issues. Until June 2021, there had been no update from Project Co /Alstom on how to address the concerns emphasized by the City in its May 4, 2020, response to Project Co’s revised Rectification Plan (*OTT-RTG-*

*RLET-0547 - Project Co Revised Plan*). The update in June 2021 was provided by ALSTOM in presentation *OTT LRV I ABB APS*, dated June 7, 2021. The outline of the presentation indicated that due to a lack of support from the current APS supplier Adetel in addressing the repairs ALSTOM had identified an alternative source for a replacement APS from ABB. The forecasted schedule from ALSTOM is shown below, however, as of this date we have no further update on the status of this schedule:

|   | Date           |
|---|----------------|
| <b>APS 1500V – FAI</b>                      | July 2021      |
| <b>Arrival of ABB APS</b>                   | End July 2021  |
| <b>Release of TCMS SW updated version</b>   | July 2021      |
| <b>APS First Mounting Review in Ottawa</b>  | August 2021    |
| <b>Static and Dynamic Testing</b>           | September 2021 |
| <b>Serial implementation (TS59 onwards)</b> | January 2022   |

Source: ALSTOM

When the LRVs are coupled in multiple with each other to form a train consist, there have been reports of battery charging faults in which the Low Battery Warning light activates to alert the driver. Alstom state that this is due to the APS Main Processing Unit (“MPU”) failing. As a result, both APSs on the affected vehicle stop the charging of batteries, causing loss of auxiliary power. Alstom advised when this happens the operator must detrain passengers at the next station and return to the depot, otherwise there is a risk the battery nominal operating voltage will be insufficient to maintain auxiliary control systems, including the operation of the emergency electromagnetic track brakes, resulting in a complete train consist failure.

In addition to the battery charging issues, there has been other known faults regarding failure of the Insulated-gate Bipolar Transistors (“IGBT”) due to transient overloading of devices such as the OCS supply being interrupted due to combinations of overvoltage/overcurrent.

### 3.1.12.2 Auxiliary Converter disruption log

The *Disruption\_Log\_Expanded\_Dec\_2020\_Jan\_2021*, indicates the following APS/battery voltage issues between December 2020 and January 2021:

- APS issues with vehicle - gaps in service - LRV20 (lack of ERO) 09/12/2020
- Battery issues LRV21 (marked as coupler issues) 09/12/2020
- APS loss on LRV05 16/12/2020
- Low battery voltage on LRV14 24/01/2021
- APS code + tons of missed launches 25/01/2021

Considering the recent dates on the disruption log it is evident that the APS battery charging issues are still prevalent. No other information/written confirmation has been provided including whether further investigation is being carried out to determine why these APS errors still occur.

However, the Maintainability Reliability report for Jan 2021 shows in section 2.5 Backlog of Deferred Maintenance that there are several APS related items listed in the relevant table, including missing APS modules or related sub-components from 1107, 1138, 1142 and 1103. Due to these items being missing from these vehicles it is assumed they are unavailable for service. This further demonstrates there is a serious reliability issue with this equipment/design/application.

This report has been developed under a privileged and confidential assignment on behalf of the City of Ottawa. While the report has been prepared for release to City Council as requested by the City and counsel for the City, neither the City nor its' counsel waive privilege over the overall assignment.

### 3.1.12.3 Auxiliary Converter mitigation

The table below taken from the Project Co *Confederation Line Major Issue Plan*, states that new software will be implemented and validated by August 2020. This is to be detailed in TCMS software version C14 to limit IGBT overvoltage and overload during power supply interruptions.

**Figure 3.85: Major Issue Plan (APS)**

| Problem  | Cause   | Solution identified  | Achieved to date | End date | R | Y | G | Comments                       |
|--|---|--|------------------|----------|---|---|---|--------------------------------|
| CVS (auxiliary converter) high failure rate, loss of spares and LRV availability | Consequential CVS failures owing to short circuit on line | Simulate failure mode and identify suitable protection methodology |                  | Oct-20   |   |   |   | Root Cause under investigation |
|  | IGBT failure owing to transient overloading of devices    | Software upgrade to limit IGBT loading during supply interruptions | 20/39 SUs        | Aug-20   |   |   |   | 20/39 SUs has been completed   |

Source: The City

Alstom state that they are performing system level tests with the OCS and CVS, which include a full-scale arcing test while monitoring APS (simulating ice) and short circuit tests APS to identify root-cause failures. We understood that no test reports or analysis have been provided to date. However, Alstom has concluded that all ongoing issues with the APS can be corrected through software mitigation procedures by upgrading the TCMS, which includes software version C17, currently under testing.

### 3.1.12.4 Auxiliary Converter overview

Very little information has been provided with regards to the low battery alerts due to the MPU failing, preventing both on-board APSs charging the batteries, causing loss of auxiliary power. Also, there is no reference to any mitigation measures being put in place (e.g., software upgrades).

No further evidence has been provided from Alstom whether the proposed C14 software has been implemented on all LRVs, and if the issue has been resolved.

It is evident from the more recent Project Co. reports and the disruption log that the low reliability of the APS units is still prevalent. Mott MacDonald would like to see from Alstom, APS reliability information, root cause analysis, and repair reports to better understand the situation and identify if there are systematic issues affecting the APS units.

During the LRV pre-shipment inspection of LRV51 at the Brampton manufacturing facility (February 22 to March 5), it was observed by the RVI that two pre-used APS units had been installed on this vehicle. However, it was observed that these APS units at the Brampton facility do not appear to be a retrofit but a repair, as approximately 15 used APS units have been seen on the shop floor at the Brampton facility waiting to be repaired. Without additional information, it is assumed these used units waiting to be repaired are ones that failed during revenue service in Ottawa. There is an area in the Brampton facility dedicated to the repair of APS units, and a representative for the OEM, Adetel, is on-site full time performing the repairs (**Figure 3.86**).

**Figure 3.86: Pre-Used APS Unit Installed**

Source: Mott MacDonald site inspection

As previously discussed above, the apparent lack of configuration control and traceability for vehicle related modifications/rectifications is a concern, if the repaired/used APS units that are refitted to production vehicles are in an unmodified state i.e., without the proposed software update. This could result in further reliability issues with the new LRVs coming from the Brampton facility.

**Figure 3.87: APS Units on The Brampton Facility Shop Floor**

Source: Mott MacDonald site inspection

### 3.1.13 High-Speed Circuit Breaker

#### 3.1.13.1 Introduction to High-Speed Circuit Breaker issues

Although not considered to be the root cause of vehicle failure, the High-Speed Circuit Breaker (“HSCB”) errors are likely to be a consequence of another system (e.g., line inductor flashover) failure. As previously stated, the impact of a line inductor failure is causing the line contactor tips to weld together, resulting in a ‘line conductor stuck closed’ fault. When LRVs are coupled in multiple, this leads to the following consequences:

- The HSCB to be locked open on the affected LRV because the HSCB is not allowed to close with a line contactor in the stuck closed state.

This report has been developed under a privileged and confidential assignment on behalf of the City of Ottawa. While the report has been prepared for release to City Council as requested by the City and counsel for the City, neither the City nor its’ counsel waive privilege over the overall assignment.



- The locked open HSCB leads to the consist being stranded because the TCMS, at present, will not allow the coupled consist to operate unless both HSCBs are closed.

### 3.1.13.2 High-Speed Circuit Breaker disruption log

According to the recent disruption log between Dec 2020 – Jan 2021, there have been the following issues recorded regarding the HSCB:

- Inspection for high-speed breaker issue on LRV19 11/01/2021
- LRV13 Power loss 13/01/2021
- HSBC issues on LRV03 21/01/2021

NOTE: There may be other HSCB-related faults within this fault log, but not all fault descriptions are clear/concise and could lead to incorrect interpretation.

### 3.1.13.3 High-Speed Circuit Breaker proposed mitigation

As discussed in previous Mott MacDonald findings and review of the Rectification Plan, the TCMS software was blocking the authorization of traction in the event of any HSCB opening. This allowed the vehicle to only be moved at low speed in the towing mode, causing delays in the Ottawa light rail service. Alstom has made proposed improvements to the TCMS software (Revision C16) such that if the HSCB does trip in one car it will only lead to a single degraded condition and train removal, without the need to activate towing mode.

**Figure 3.88: Major Issue Plan (HSCB)**

| Problem  | Cause   | Solution Identified   | Achieved to date | End date | R | Y | G | Comments  |
|--|---|---|------------------|----------|---|---|---|---|
| Rooftop flashovers of line inductors, caused by winter brine contamination of inductor. Line contactor welding caused by high current. OCS tripping and affecting service. | Cracks in inductor encapsulation allowing electrolytic conduction to earth when water/ brine enters inductor compartment. | Rework of line inductor with improved design and process. Revised line inductor on target, delivery and installation June-2020  | 8 SUs completed  | Feb-21   |   |   |   | 7/39 SUs completed  |
|  | Lack of detection of the fault causes eventual contactor welding  | Review of propulsion logic to detect when there is a combination of undervoltage and overcurrent and provide appropriate isolation of inverter New line contactor revision as well as pre charge contactor management proposal 4/22 |                  | May-21   |   |   |   | Retrofit to be scheduled with Line inductor                 |
| Failure of 2 LRV trains because of single HSCB opening   |   | Fix to TCMS software to permit movement with single HSCB opening. Change request has been tested and validated. Evaluation of the results of the global software. Development of software subjected of the successful validation    | 36xSU            | Aug-20   |   |   |   | TCMS (1.2.5.12) Validation Completed , Deployment on Going. |

Source: The City

### 3.1.13.4 High-Speed Circuit Breaker overview

Considering the recent dates on the disruption log, it is evident that the HSCB issues are still prevalent. No other information has been provided by Project Co to confirm whether any further investigation is to be carried out to determine why these HSCB errors still occur.

While reviewing the PA, it became apparent that the operation of the HSCB appears noncompliant to the *Schedule 15 – 2 Project Agreement, section 3.23: High Voltage Distribution & Auxiliary Electrical Equipment*, of the PA which states:

(c) *The HSCB shall:*

*(ii) Have trip settings coordinated with the Traction Power system Design to prevent nuisance tripping of Traction Power breakers; and*

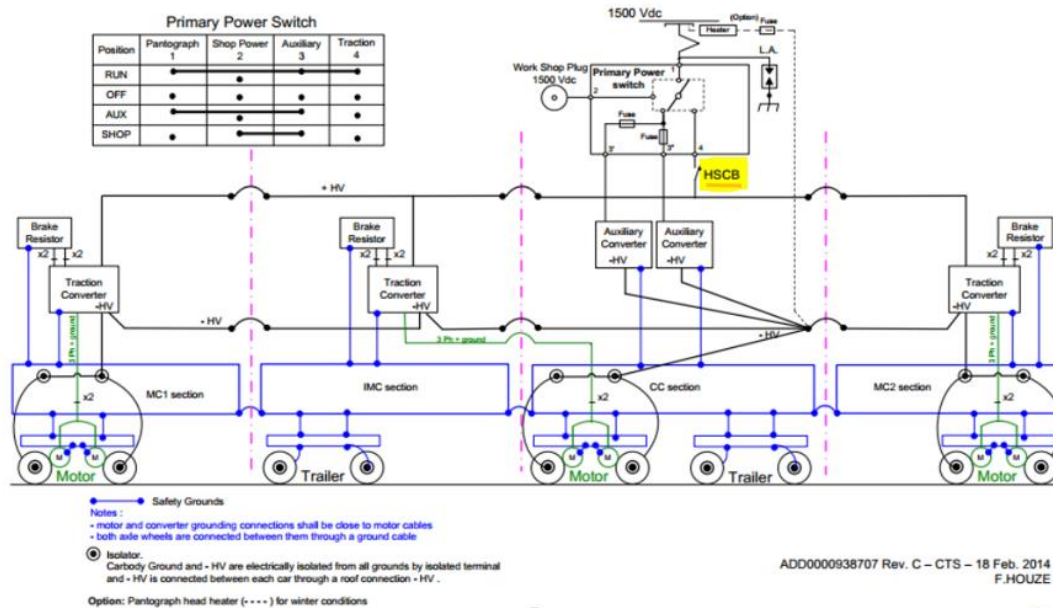
*(iii) Provide a remote trip and reset function to be controlled by the propulsion system and auxiliary power.*

This report has been developed under a privileged and confidential assignment on behalf of the City of Ottawa. While the report has been prepared for release to City Council as requested by the City and counsel for the City, neither the City nor its' counsel waive privilege over the overall assignment.

(d) Output from the HSCB shall be split into three separately protected main circuits: Traction Power A, Traction Power B and Auxiliary Power.

The image below, taken from Alstom's MTNMTN-TLOTT-WMS-003 - Citadis Spirit Vehicle Operating Manual\_Rev E, illustrates that when the HSCB is open, the traction converter will be isolated from the 1500Vdc high voltage supply, as required by 3.23 (c iii) above, whilst the Auxiliary Power Supply will not be affected and remains energised, which goes against requirement 3.23 (d).

**Figure 3.89: Citadis Sprit 404 - 1500Vdc HV Supply Circuits**



Source: Alstom

Although Alstom's HSCB design is noncompliant to the PA clause 3.23 (d), Mott MacDonald is aware from previous/ongoing experience that Alstom's Citadis Spirit HSCB functionality is in fact consistent with other similar LRV HSCB designs/functions, noting that the PA requirement would result in a total loss of power supply for HVAC, low voltage DC power, battery charging, and lighting for instance, in the event of an emergency brake application.

### 3.1.14 Passenger Doors

#### 3.1.14.1 Introduction to passenger door issues

There have been ongoing issues with passenger doors not opening. Mott MacDonald has requested specific details, such as the frequency of occurrences, if they occur on the leading or trailing car of a multiple consist, if they are localized to specific vehicles, and if a certain door or door location has a higher fault rate. Without this type of information, we are unable to fully evaluate this issue, for instance, did the door actually fail to open on its' own, or was it prompted not to open because of a different system input (so the door actually worked properly but the other input may have been faulty).

The door system has apparently undergone software and mechanical modifications to address several known reliability issues specific to the doors themselves (e.g., new sensitive edges).

This report has been developed under a privileged and confidential assignment on behalf of the City of Ottawa. While the report has been prepared for release to City Council as requested by the City and counsel for the City, neither the City nor its' counsel waive privilege over the overall assignment.

Recent discussions with the City indicated that that door reliability has improved, although the *Disruption\_Log\_Expanded\_Dec\_2020\_Jan\_2021* indicates eight faults between December 2020 to January 2021. The log entries for these faults have been listed below.

#### 3.1.14.2 Passenger door disruption log

According to the recent disruption log (*Disruption\_Log\_Expanded\_Dec\_2020\_Jan\_2021*) between Dec 2020 – Jan 2021, there have been the following issues recorded regarding passenger door failures. However, as can be seen in the fault description there is very little information provided to determine the specifics of each fault (e.g., doors not opening/closing):

- Door issues on LRV1101 (15/12/2020)
- Door issues on LRV1110 (15/12/2020)
- Doors on LRV1115 (19/12/2020)
- Door on LRV1121 (27/12/2020)
- Door fault on LRV1109 (16/01/2021)
- Door on LRV1132 (19/01/2021)
- Door issues on LRV1114 (20/01/2021)
- Door issues on LRV1110 requires early reduction (22/01/2021)

#### 3.1.14.3 Passenger door proposed mitigation

- The proposed software modifications within the Project Co *Rectification Plan RTG-OTT-00-0-LET-0938 - RTG Revised Plan (R1)* are as follows: Introducing the Door SIL-2 software v1.40, which will address the two following door failure modes:
  - a. Doors randomly not opening (trailer unit, both units, and just one door). Door not opening in trailer vehicle has been characterised and is due to bouncing effect between relays and Door Control Unit (“DCU”). The door system supplier is incorporating a protection within the next software release.
  - b. Push-back (H-bridge overload). The door system has been exposed to passenger behaviour, that result in forcing doors open, this can cause a door motor over-current fault.
- Hardware modifications – Door Isolation. The improvement is based on two specific modifications:
  - a. Modification to avoid any desynchronization between the door leaves, (even the smallest one desynchronization).
  - b. Modification of the Lefthand Crank to ensure that the pin properly engages in the crank hole.

#### 3.1.14.4 Passenger door overview

The door supplier Wabtec had a retrofit program in place to replace sensitive edges due to the doors cycling too many times with no actual obstruction in the way. The proposed solution was to install a new door seal material. In addition, a modification to address an issue with the Emergency Door Release (“EDR”) system, due to the release activating during the first stage of the two-stage process. The EDR’s first stage is to generate an alarm to the operator, who can evaluate the validity of the request and take any corrective measures. The second stage is to open the doors after the vehicle detects no-motion.

During the site visit in September 2020, the City reported an incident related to a vehicle’s doors not opening. From the limited information provided to Mott MacDonald, this issue could potentially be caused by the vehicle not receiving a no-motion signal, rather than an issue with

This report has been developed under a privileged and confidential assignment on behalf of the City of Ottawa. While the report has been prepared for release to City Council as requested by the City and counsel for the City, neither the City nor its’ counsel waive privilege over the overall assignment.

the door system itself, as the doors cannot be enabled if the vehicle is still detected as moving, even though it has actually stopped. Another possible cause is that the fault could be related to a faulty/missing speed sensor, causing false speed/movement readings, as there is a history of speed sensors falling off vehicles.

Mott MacDonald has not been provided with an update on the status of the door modifications across the fleet, therefore we are unable to determine whether the recent faults are still related to those previously seen or if they are new issues.

### 3.1.15 Vehicle Braking

During the site visit Mott MacDonald observed failed brake calipers in the inventory area four of which were tagged for leaks and one that was tagged for “Fire Damage.” When this was queried, Alstom described the following rescue scenario:

One vehicle in a consist had a friction brake failure that was causing a propulsion inhibition which prevented the vehicle from moving after it had loaded/unloaded at a stop. The driver was instructed to electrically release the affected bogie brakes and bring the consist back to the MSF. One of the brake calipers did not release when they used the bypass switch which resulted in the vehicle being moved with the brake applied on this caliper position. This resulted in the brake caliper overheating and catching fire while returning to the MSF. Based on the QA tag’s defect description, “Fire Damage,” it is assumed there was smoke trailing behind the consist when it returned to the MSF.

Although it’s unrelated to the incident with the caliper, further details emerged from that discussion regarding how Alstom releases the brakes for other scenarios. As typical with most current vehicle designs, the Citadis has three methods of releasing brakes in the event of a brake defect:

1. Bypass panel has a switch that commands all calipers on a bogie to apply release pressure using Emergency Hydraulic Unit pressure
2. Hand pump can be connected to hydraulic lines and all calipers can be released on a vehicle by applying pressure directly to the calipers using the pump
3. Each individual caliper is released using a pull cock handle on the brake caliper itself

Due to the “Fire Damage” event, Alstom has not used the electronic release for the last two months while they await the conclusion of an investigation on the matter. In addition, the hydraulic pump is not currently being used because an incorrect fitting is currently installed on all the vehicles and use of the pump causes hydraulic fluid to “spray everywhere.” Therefore, anytime a vehicle’s friction brakes must be released, all calipers must be individually released by hand and Alstom indicated that an audible indication (pad clinks against disc) is being used to verify each caliper truly released.

Based on the above revised recovery approach, without a detailed accounting of the actual operational procedure for dealing with an in-service fault of this type, Mott MacDonald have some concern about this process as the manual release of the bogie brakes will result in no braking capability on the relevant bogie, with a reduction in braking power available for the entire vehicle/consist. With this type of defect, it is typical to remove passengers and apply a speed restriction on the vehicle/consist depending upon how many bogies are affected due to the reduced braking force. This is a process that needs to be carefully managed as this manual brake release operation is typically carried out by technical staff, not the operator, which requires the need for the technical staff to be called out to attend to the stationary vehicle.

The complexity of this process is compounded if it is required while the vehicle is at a platform. There is not enough clearance to allow the side skirts to be removed while the vehicle is at a

passenger platform. The vehicle will need to be towed out of the platform to allow enough access. This towing process is complicated by the brakes still being activated through the towing procedure.

Following operational issues with the isolation of individual bogie brakes, it appears that Project Co. are mechanically releasing individual friction brakes to allow vehicles to be moved. For example, Alstom regularly uses a shunter to move unpowered vehicles around the MSF without any form of braking, including all movements at the wheel lathe for wheel truing, with the brakes released manually, which in itself presents a potential risk of a vehicle running away in an unbraked condition. Mott MacDonald recommended a review of these procedures to determine these risks are being suitably managed.

### 3.1.16 Sanding System

Incorrect sand was initially supplied, which lead to clumping and freezing, clogging the on-board sand delivery system. This sand is an integral part of the vehicle braking and acceleration calculations and may be contributing to the wheel flats/braking/over speeding issues. New sand has now been supplied and was observed as part of the on-site visit.

**Figure 3.90: Photo of New Coarser Sand**



Photo Source: Mott MacDonald site inspection



**Figure 3.91: Photo of Original Powdery Sand**

Photo Source: Mott MacDonald site inspection

The functionality of the on-board sanding system and new sand type needs to be confirmed against the OEM specification requirements. In addition to the on-board sanding system, the new sand type needs to be confirmed with the MSF sand dispensing system OEM to ensure there are no compatibility issues.

Mott MacDonald recommended that the maintenance procedures and LRV Daily Checklist be amended to require collection of necessary data to provide traceability and continuity on how often the sand boxes require refilling and by what amount, as this may also provide an indication whether the relevant sander is working or not. The current vehicle daily checklist states that the minimum permitted sand box level is 20% before it requires refilling, which without any recorded data its unknown if a 20% sand level is adequate for daily service, especially during winter operations. Until such time sand usage data is available to inform sand filling amounts/frequency, it is recommended that the minimum sand level is increased to at least 50% but with the aim of ensuring they should be full before entering service.

During winter it is recommended to top-up the sand boxes and test the sanding system functionality daily prior to operating on the network.

It is recommended that the maintenance procedures be amended to require collection of necessary data to provide traceability and continuity on how often the sand boxes require refilling and by what amount, as this may also provide an indication whether the relevant sander is working or not.

Regular functionality checks of the sand hose heater operation should be carried out.

The usage of this sand needs to be monitored to evaluate any inconsistencies in sand usage, either too much, or too little, as these are indicators of the overall performance of the sanding system.

### 3.1.16.1 LRV Daily Checklist

Further to the above, the LRV Daily Checklist is a series of safety related checks and tests that are carried on each vehicle prior to entering passenger service. This checklist was specifically reviewed to determine the process for ensuring safety systems such as the sanding system are being checked and tested daily, as there have been previous concerns from the City about vehicles entering service with inoperative sanding equipment.

The review confirmed there is a requirement to check and test the sanding system; however, the structure of the checklist can be both confusing and ambiguous which could lead to items being missed. For example, there are several other tasks like the sanding check that include multiple checks within one task, for instance the external lighting check includes several different lighting systems combined under a single task. Based on the above, we recommended that the LRV Daily Checklist is revised to ensure the tasks are broken down into a logical sequence for each area (e.g., cab, passenger areas, exterior) and multiple checks are separated into individual tasks to ensure each item is ticked off accordingly by the operator.

### 3.1.17 Speed Sensors

There has been at least one known issue with a speed sensor falling from its truck/bogie mounting location. As previously discussed in the track section, rail corrugation is prevalent in several locations around the System, including around the curve headed eastbound to Tremblay station. Corrugated track is most likely the cause of this issue and if not addressed is likely to lead to other truck/vehicle related issues manifesting themselves especially on the truck where there is limited suspension damping for items mounted on the truck frames and/or the un-sprung areas such as those mounted on the axle boxes (e.g. sand ejector pipes/nozzles/brackets, flange lubrication pipes/spray nozzles/brackets) and wheels (e.g. traction/safety earth return devices).

The longer the truck/vehicle mounted components are subjected to the high levels of vibration currently being experienced from the severe rail corrugation seen on the System, the worse it will get, as it will accelerate their fatigue life, which will lead to premature failure of truck/bogie mounted equipment/brackets including speed sensors. Until such time the rail corrugation has been addressed, we recommended that additional truck and truck-mounted equipment and running gear inspections be carried out. This is necessary to mitigate the risk of components detaching and falling from the vehicle, as this has already occurred with the speed sensors. It is also important to note that the integrity of the speed sensors and their respective signals to the traction/braking systems is critical for the safe operation of the vehicle, as they can influence speed/braking and associated ATO interfaces. Noting that the integrity of the speed sensors and their signals to the traction/braking systems is critical to the safe operation of the vehicle, as they can influence speed/braking and associated ATO interfaces.

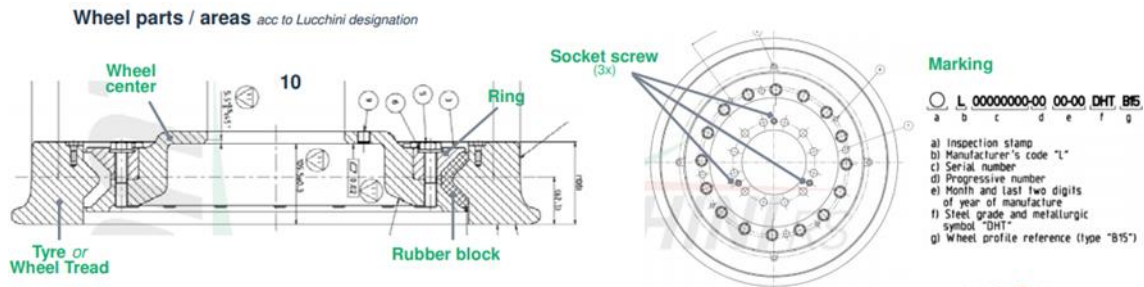
It is also important to note that an initial Track Load Survey conducted in February 2021 (track quality check) showed significant axle load levels being experienced due to the severe rail corrugation seen around the system. This further confirms our concerns that the severe level of rail corrugation is very likely to result in both short- and long-term fatigue life issues being experienced by the vehicles, especially for the bogies, running gear and associated mounted equipment such as the speed sensors. Following the rail grinding of the track in July 2021, a further ride test was conducted in August 2021, which showed an improvement in the axle acceleration rates but there was still an uneven level of acceleration rates dependent on the track location areas.

### 3.1.18 Cracked Wheels

Our initial conclusions from this issue tend to indicate that the root cause has been identified, which was related to the leaving in place of the socket screws during the wheel assembly (see **Figure 3.91**), which protruded out of the threaded holes used to extract and remove the wheel. Additional wheels have since been identified with cracks appearing in the same manner as the previous, but without further information we are unable determine whether they are related to what has been found previously.

Going forward, it is important to understand Alstom’s mitigation strategy for preventing the issue from being repeated during future manufacturing, maintenance, and overhaul of the wheels. However, recent observations by Mott MacDonald at Brampton have identified that wheels are still arriving on-site with the screws still in place and has resulted in new vehicles being sent to Ottawa with them still in place. Mott MacDonald were aware that 1152 had been transported to Ottawa with them in situ, but this would be the last vehicle with them in place.

**Figure 3.92: Wheel Parts Including Socket Screws**



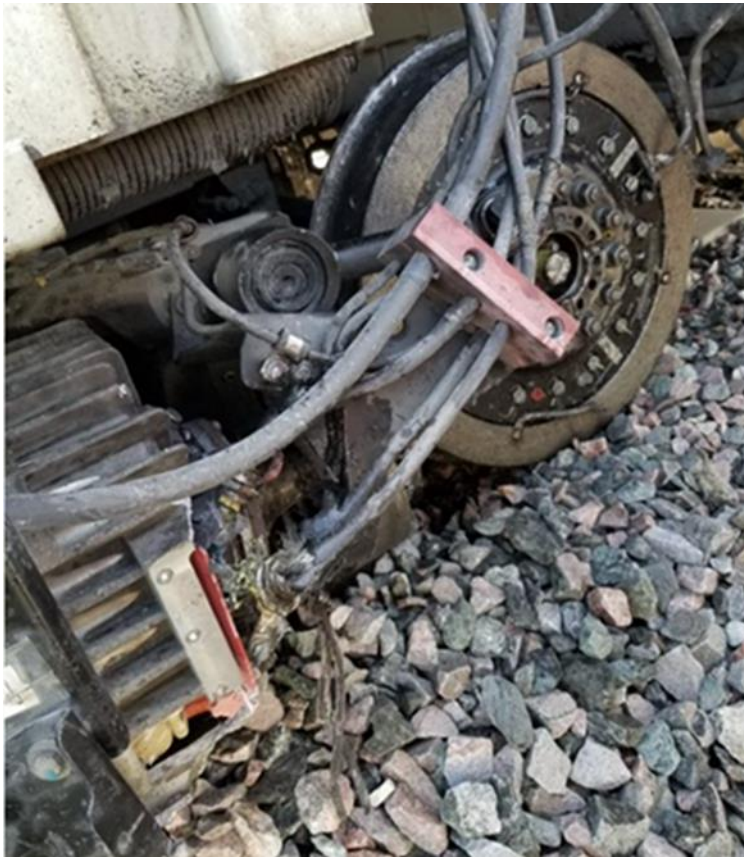
Source: Alstom Presentation – Cracked Wheels Root Cause Investigation 20.07.2020

## 4 Mainline Derailments

In August and September 2021 there were two highly publicized mainline train derailments that took place within a six-week period. Following the second derailment in September 2021, the service was shut down for 54 days while investigations took place and repairs to both the infrastructure and relevant vehicles were carried out, before services could resume.

While this Section of Volume 5 is not intended to cover the details of the derailments, as they have been covered elsewhere, it is however important to note that the confirmed primary cause of the September derailment was related to improperly torqued bolts on the gearbox, see **Figure 4.29** below. The investigation identified that there are issues related to maintenance and management practices, which further supports our other observations and findings related to vehicle maintenance concerns.

**Figure 4.29: LRV1121 Derailment September 2021**



Source Mott MacDonald

The August derailment was related to a wheel bearing failure on 1119 that resulted in the detachment of a wheel which led to the train being derailed, see **Figure 4.30** below. It is understood that the root cause of this derailment is still under investigation.



**Figure 4.30: LRV1119 Derailment August 2021**

Source Alstom

It is understood that the root cause of this derailment is still under investigation. However, the current known situation surrounding these derailment events can be summarized as follows:

- Root cause analysis for 1119 derailment in September is still outstanding..
- The root cause of the August derailment of 1121 has been identified and confirmed as being due to issues related to maintenance and management practices. This led to improperly torqued bolts on the gearbox coming loose, which resulted in the gearbox becoming detached from the wheel and the subsequent derailment of the vehicle.
- The two derailments appear to be unrelated events – human error vs bearing failure.
- Alstom needs to continue with wheel bearing hub inspections and conducting physical checks.
- A Return to Service Plan was produced to outline the mitigations necessary to safely return the fleet back to operational status.

As of this time, Mott MacDonald have not been informed of any further findings or root cause of the wheel hub/bearing failure that occurred to 1119 in September. However, while the last report received for this derailment included many details related to the investigation findings, observations, and proposed mitigations there is no reference to related modifications that had already been proposed to be carried out to the wheel bearing housing. The modifications were previously raised by ALSTOM, prior to the derailments, in their presentation *OTT LRT Axle Spline Connection*, June 30th, 2021. The purpose of these modifications is to reduce the risk of spline shaft wear which may lead to a complete loss of drive between two wheels of a wheelset. It is important to note that the splined shaft is located within the same bearing housing that failed resulting in the detachment of the wheel and subsequent derailment.

While there is no known evidence to suggest these modifications, which were proposed before the derailments, are related it would be considered prudent to have included them in the investigation, even if its just to confirm there is no relationship between a potential spline failure and subsequent overheating of the bearing assembly that may have contributed to the ultimate



failure. We are still unaware if the proposed modifications have been carried across the fleet, as they had originally been planned to start in late 2021.

#### Return to Service Plan – Operational Considerations

The following Mott MacDonald observations are based on our independent analysis of the information and data obtained from the City, Project Co, and from our own on-site observations and expertise of investigating rail vehicle incidents, accidents including derailments:

- The Document provided to us, *613CORR1\_BN\_Bogie and Underframe Inspection* is essentially an inspection procedure rather than “The Return to Service Plan”
- The plan does not include a timeline for its implementation, nor a strategy on how it is intended to resource, train staff, or implement while dealing with routine maintenance tasks
- Many items of vehicle equipment were included that are not relevant to the derailments
- Operational aspects are not included/considered to support mitigation aspects that could be introduced, for example, new/emergency operating procedures for drivers or control room staff
- No overarching system risk assessment was provided, only individual assessments for 1119 & 1121
- What, if any, new processes, or process changes have been implemented to prevent reoccurrence?
- RTM state other technologies for early detection under review
- The Operator should consider new operational procedures (mitigation measures) as a result of these derailment events
- Operational Staff should undergo specific briefing/training to make them aware of early indications that could mitigate the risk of a further related derailments
- Current driver/operator/station/control room staff processes and procedures may need reviewing and updating
- Stations have attendants on both platforms, and they should be instructed to be extra vigilant to issues with the vehicles (both tracks) – noise, smells, panels flapping, anything out of the ordinary
- What information/tools are available to the Control Room to monitor (and thus what the observers need to report) in terms of safe operations of the railway
- Slip slide, we question if this happening too often to be noticed (e.g., excessive track lube grease is being applied/spread across the system by the wheels which is likely to result in spurious slip/slide events even during dry weather conditions) – may also be connected to overspeed events
- Excessive automatic sanding applications would have been indicated on the driver’s desk panel by the sanding button being illuminated as a result of excessive wheel slip/slide detection – this can be used as a means of mitigation
- A traction fault indication should have been displayed to the operator due to loss of drive and different motor/wheel rotational speeds on the same bogie – was this displayed?

## 5 Recommendations – Revenue Vehicles

The list below is a summary of the recommendations made in this Volume, grouped by priority to identify those tasks we believe that Project Co should undertake immediately and those which could be completed in the medium-term.

Please note that many of our recommendations could impact the Project design, and so Project Co will need to agree with the recommendations made and provide design drawings/information/plans to implement the changes.

### 5.1 Revenue Vehicles - Priority

#### Mainline Derailments

1. It is recommended that the root cause analysis related to the earlier mainline derailment be completed as soon as possible, and findings be incorporated as appropriate into Project Co maintenance practices moving forward.
2. It is recommended that Project Co's maintenance practices be reviewed and revised as appropriate, to demonstrate that Project Co has policies and procedures in place to mitigate against similar human errors recurring in future.

#### Backlog of Deferred Maintenance

3. It is recommended that an independent review of these vehicles and associated materials/equipment is carried out as part of an overall asset condition assessment, as it's likely these assets may deteriorate if left in an inoperable condition for long periods of time.
4. It is recommended that a detailed independent analysis be conducted of items of equipment suffering from premature failure.
5. It is recommended, possibly in conjunction with the items above, that an independent review is carried out to understand the root cause of the deferred maintenance backlog.

#### Vehicle CCTV

6. It would appear there are still issues with the vehicle-to-station CCTV communication. As this system does not appear to be meeting the requirements of the PA it is recommended to carryout a more detailed analysis of the system and any proposed mitigation measures to address the situation.

#### Wheel Flats

7. There have been discussions about possibly reducing the EB deceleration rate, which we recommended that this needs to be carefully considered before any implementation is carried out.
8. It is recommended that the rate and magnitude of wheel flats, including the sanding system performance, needs to continually be observed and monitored.

#### Wheel Truing

9. Following wheel re-profiling the tread surface including flange should not have a coarse surface. A Good Industry Practice example calls for a surface roughness no coarser than 12.5 µm (N10). This also aligns with the wheel lathe OEM standard.

### Wheel Wear Recording

10. It is recommended to carry out a sample validation of the wheel diameters against what the wheel lathe is currently producing, as a review of the wheel truing records shows several anomalies.
11. It is recommended to carry out a wheel profile validation check against what is being produced by the wheel lathe, including the hand measuring gauges used post wheel truing and for routine maintenance.
12. Wheel back-to-back dimension validation checks against what the wheel lathe is measuring should be carried out on a sample number of trucks/vehicles (e.g., 10%). The checks should include at least three equally distanced measurements around the back face of the wheel.
13. It is recommended to validate the wheel flange and tread profiles, and wheel diameters are being maintained in accordance with the relevant standards and Good Industry Practice.

### Wheel Flange Lubrication System

14. In addition to the one-off fleet check noted above, we recommended ensuring that the correct OEM requirements and any special tooling are available to the maintenance staff, and whether they have undergone the correct level of training to carry out the adjustments.
15. Checks should be carried out to confirm the correct alignment of the flange lubricator spray nozzles after all wheel reprofiling/changing is completed due to the wheel diameters being reduced/increased.
16. The on-board lubricant reservoir needs to be monitored by Project Co to determine usage in order to determine the maintenance intervention timescales, as it is not recommended to run vehicles between maintenance intervals with no lubricant being applied, otherwise the flange/rail conditioning will be lost.

### Abnormal Pantograph Carbon Wear/Damage

17. It is recommended that Project Co produce a check list to include the recording of actual pantograph raising forces against the OEM values including tolerances, vehicle number, pantograph serial number, date of check and mileage when the carbons were replaced/last inspected and recorded etc. These details should be recorded on a template as a record going forward and for all future pantograph inspections and related work adjustments. This will provide an historical reference for each vehicle in order to determine if the raising force has changed and or to provide a record of any other pantograph related observations/concerns.
18. It is recommended that Project Co establish processes to create and capture the necessary data to provide traceability and continuity on how often a specific pantograph has been adjusted, how long it has run, and the magnitude of any adjustments and carbon replacements have been made. These processes should be continued until such time the issues have been reduced/eliminated to an acceptable level of risk. In some cases, it would be prudent to adopt some, or all of, the above as Good Industry Practice for maintenance and to be incorporated into the current maintenance requirements.
19. During the winter operating period the vehicle pantographs are typically fitted with "winterized carbon strips" to help with current collection from the OCS when there is ice/snow accumulation on the contact wire. Mott MacDonald recommended the pantograph setting procedures are reviewed and revised accordingly as any out of tolerance upward force (less/more) could be a contributory factor to the known grooving/wear/damage issues being found on the pantograph current collectors.

## Vehicle Braking

20. It is recommended a review of these procedures associated with mechanical releasing individual friction brakes to determine that risks are being suitably managed.

## On-board Sanding System

21. During winter it is recommended to top-up the sand boxes and test the sanding system functionality daily prior to operating on the network.
22. It is recommended that the maintenance procedures be amended to require collection of necessary data to provide traceability and continuity on how often the sand boxes require refilling and by what amount, as this may also provide an indication whether the relevant sander is working or not.
23. Until such time sand usage data is available to inform sand filling amounts/frequency, it is recommended that the minimum sand level be increased to at least 50%.
24. Regular functionality checks of the sand hose heater operation should be carried out.
25. The usage of this sand needs to be monitored to evaluate any inconsistencies in sand usage, either too much, or too little, as these are indicators of the overall performance of the sanding system.

## LRV Daily Checklist

26. It is recommended that the LRV Daily Checklist is revised to ensure the tasks are broken down into a logical sequence for each area (e.g., cab, passenger areas, exterior) and multiple checks are separated into individual tasks to ensure each item is ticked off accordingly by the operator

## 5.2 Revenue Vehicle – Additional Recommendations

It is recommended that:

1. Project Co assess the deferred vehicle maintenance list and develop a strategy for dealing with this backlog, in a prioritized manner. Outstanding deferred maintenance items, including safety critical and reliability related deferred items, as well as outstanding modifications, should be listed on a vehicle-by-vehicle basis to identify the level of effort required to return each vehicle to operational service, and a simple system used to catalogue each vehicle's repair priority and status.

In the short term, it is recommended that Project Co conduct a focused inspection on known issues with equipment on the LRVs. This should include, at minimum, the following:

2. The functionality of the on-board sanding system and new sand type needs to be confirmed against the OEM specification requirements.
3. The new sand type needs to be confirmed with the MSF sand dispensing system OEM to ensure there are no compatibility issues.
4. That , until such time the rail corrugation has been addressed, additional truck and truck mounted equipment and running gear inspections be carried out; this is necessary to mitigate the risk of components detaching and falling from the vehicle, as this has already occurred with the speed sensors.
5. A one-off check and correction adjustment of the flange lube nozzles, in accordance with the OEM requirements.
6. Project Co select a vehicle and install new pantograph carbon strips and paint the horns and leading/trailing carbon faces in a bright color such as yellow. Once installed, check and record the upward force value in accordance with the correct OEM process including using a suitable measuring device (e.g., spring balance). Record both the pre and post adjustment values on the relevant record template, and take the vehicle

around as much of the MSF as is possible, then return the vehicle to the roof inspection bay and carryout a visual inspection of the carbons and horns in order to identify if there is any damage (e.g., chipping of carbons) and/or scrapes to the yellow painted surfaces. Record all findings and observations on the record template.

7. A similar exercise to above should be carried out around the complete network by undertaking one round trip and then return the vehicle to the MSF to inspect, measure and record all findings and observations. Depending on the findings it may be necessary to repeat the process again until its possible to breakdown the areas on the network where potential interface issues may be occurring.
8. In the longer term, Project Co adjust their maintenance practices to create the necessary data to provide traceability and continuity on how often assets have been adjusted, how long they have run, and the magnitude of any adjustments and replacements have been made, and apply a proactive approach to asset management.



# **Volume 6: Compiled Recommendations**

April, 2022  
Confidential

# Contents

|       |   |     |
|-------|---|-----|
| 1     | Introduction to Volume 6                                | i   |
| 2     | Recommendations – Volume 1                              | 193 |
| 3     | Recommendations – Volume 2                              | 194 |
| 4     | Recommendations – Volume 3                              | 195 |
| 4.1   | Rail and Track Structure                                | 195 |
| 4.1.1 | Priority  | 195 |
| 4.1.2 | Rail and Track Structure – Other Design and Maintenance | 195 |
| 4.2   | Rail Systems (OCS and Traction Power)                   | 196 |
| 4.2.1 | Priority  | 196 |
| 4.2.2 | Rail Systems – Other Recommendations                    | 198 |
| 5     | Recommendations – Volume 4                              | 200 |
| 5.3   | Priority Recommendations                                | 200 |
| 5.4   | Additional Recommendations                              | 200 |
| 6     | Recommendations – Volume 5                              | 202 |
| 6.1   | Revenue Vehicles - Priority                             | 202 |
| 6.2   | Revenue Vehicle – Additional Recommendations            | 204 |
| 7     | Conclusion  | 206 |

# 1 Introduction to Volume 6

**This Volume contains the compiled recommendations from the earlier Volumes of this report.**

The purpose of this Volume is to provide Mott MacDonald's various recommendations compiled into one document, to facilitate reference.

For detailed discussion of the technical or other considerations regarding any of these recommendations, please refer to the specific Volume from which it was derived.

## 2 Recommendations – Volume 1

There were no detailed recommendations contained in Volume 1 of this report.

## 3 Recommendations – Volume 2

There were no detailed recommendations contained in Volume 2 of this report.



## 4 Recommendations – Volume 3

### 4.1 Rail and Track Structure

The list below is a summary of the recommendations made in this Volume 3, grouped by priority to identify those tasks we recommended that Project Co undertake immediately and those which could be completed in the medium-term.

#### 4.1.1 Priority

It is recommended that:

1. RNT-risk susceptible areas such as stress transition zones, or areas where track movements have occurred, or may occur, be identified.
2. Short-term mitigation measures should be determined and implemented in RNT-risk susceptible areas, including increasing ballast shoulders, widening of the ballast shoulder and/or installation of tie anchors (not to be confused with rail anchors) to increase the lateral track resistance.
3. A season-based approach to restressing of the track should be implemented in RNT-risk susceptible areas, to mitigate the challenge regarding heat expansion and sun kinks.
4. “Critical Rail Temperature Management,” employing smart infrastructure monitoring by using rail-mounted probes that provide real-time reporting and automatically register when intervention limits are being reached, thus triggering messages sent directly to maintenance teams and drivers to inform them of any speed restrictions, should be considered at RNT-risk susceptible areas or areas where works have been undertaken and ballast is yet to consolidate.
5. Where restraining, or “continuous check rails,” are employed through curves they should be extended to terminate at least 3m into straight track.
6. Measurement of corrugation should be undertaken on the whole System using a “Rail Measurement Corrugation Analysis Trolley” or similar that allows the location, depth and wavelength to be reported.
7. It is recommended that Project Co analyze corrugation as measured above and assess whether another round of rail grinding should be undertaken in the short term.
8. Measurement of corrugation, as well as inspection for it, should be included in the maintenance regime and undertaken more frequently, at least every three months, to allow an understanding of where corrugation is forming and the growth rates. This can be used to inform a proactive program of rail grinding. Once the growth of corrugation is established, the frequency of measurement could potentially be reduced.
9. A visual and ultrasonic inspection of the wheel burn defects should be undertaken to confirm if any cracks are present.
10. A survey should be undertaken of the entire line to determine if rolling contact fatigue is present, and the severity. Ideally this would involve both ultrasonic inspection and, for short cracks, eddy current testing. If this is not possible within a short time frame, then visual inspection with the aid of Magnetic Particle Inspection should be carried out.

#### 4.1.2 Rail and Track Structure – Other Design and Maintenance

It is recommended that:

11. Installation of adjustment switches should be considered in RNT-risk susceptible locations.

12. The joints at the Rideau River Bridge have not been installed in accordance with Good Industry Practice, and as such, the inner blades should be repositioned, and pointed in the direction of traffic or primary traffic direction.
13. To determine if Project Co are meeting the Project Agreement with regard to nuisance to neighbours, track-based (pass by) noise monitoring should be undertaken at the locations where corrugation is present prior to grinding.
14. Removal of the wheel burn defects by grinding and weld repair of the rail surface or rail replacement should be undertaken.
15. A detailed wheel/rail interaction study should be undertaken to determine if the optimal wheel and rail profiles are being used. This study should seek to optimize the wheel and rail profile to minimize rail/wheel damage by ensuring good steering through curves while minimizing hunting. The study should also consider if changes to the track or vehicle would be beneficial. In addition to new profiles, it should also consider how these develop with wear over time. It should also consider whether the existing lubrication is sufficient or whether trackside lubricators are required given the high levels of wear.

## 4.2 Rail Systems (OCS and Traction Power)

### 4.2.1 Priority

For OCS, it is recommended that Project Co review the design of the following, which do not appear to be in alignment with Good Industry Practice, as it is defined in the Project Agreement:

1. Messenger wire
  - a. It is recommended that messenger wires be bonded to the aluminium OCR at all OCS to OCR transitions, at both downtown tunnel portals and on both side of St-Laurent station over both tracks.
  - b. It is recommended that the messenger wires be bonded on both tracks. The bonds installed should provide, as a minimum, equal ampacity to the messenger wire.
  - c. It is recommended that a second full section or a MW to MW jumper is installed to provide equivalent ampacity of the sections of OCS
2. Wire heights and staggers
  - a. To reduce the likelihood of a hook-over occurring, the contact wire heights should be checked and adjusted to ensure that the correct take-over as the pantograph traverses the wires
3. Jumper wires
  - a. To reduce the likelihood of a failure, the existing installation should be checked, and additional jumpers installed as necessary
4. Feeder connections
  - a. Updated data and ongoing performance monitoring records be provided, to verify whether the changes made under the Project Co Rectification Plan have solved the issues as intended. This should include written feedback as to the status and details of any changes made.
5. Section insulators
  - a. At the ends of the SI, the contact wire and runners should be set at the same height with consistent wear on all three elements, to provide a smooth transition from the contact wire to the runners or vice versa.
  - b. While it is not possible to eliminate the risk of a failure, due to other factors such as the pantograph, track and vehicle, to reduce the likelihood of a failure of the section insulator

and reduced damage to equipment, the section insulators should be checked and adjusted as necessary using a dummy pantograph fitted to the maintenance vehicle.

6. Crossover/mainline contact wire transition
  - a. A full survey of the crossover/mainline wires should be carried out and heights adjusted accordingly to provide a smooth transition.
7. Rigid rail overlaps in tunnels
  - a. A full survey of the overlaps in the tunnels should be carried out and heights adjusted accordingly to provide a smooth transition.
8. Balance weights
  - a. A full survey of the balance weight assembly should be carried out and analysis carried out to determine if travel between the two stops is enough and the weight heights are set correctly.
  - b. Specific information for each remedial or maintenance activity, detailing what is to be recorded, should be developed and added to existing check sheets in order to ensure the information gained is useful to allow for any future review and analysis to be undertaken.

For Traction Power, it is recommended that:

9. Project Co acknowledge issues with Stray Current and Rail overvoltage as specific items to be addressed in the Remediation Action Plan.
10. Project Co, based on excess stray current reports by Enbridge Gas, embark on an immediate program of remediation focussing on grounding and bonding principles deployed around the network. This should verify the status of unmonitored VLD-F and VLD-O type overvoltage protection devices, should verify track insulation levels (rail to ground testing) and carry out bonding inspections to ensure there are no direct bonding connections that could be affecting system insulation levels.
11. Project Co review and carefully consider how high accessible voltages at the rails, and the frequent operation of negative grounding devices in response, could be impacting stray current levels at adjacent utilities, and provide documentary evidence of this review and consideration to the City.
12. Project Co provide a specific review and assessment identifying how the TPS system interfaces with other disciplines, particularly when it comes to establishing clearance zones and risk assessments, i.e., allowing clearance and risk assessment processes to drive decisions regarding grounding and bonding protection measures with regard to separation, segregation, insulation, and over-voltage protection.
13. TPSS Negative Grounding Devices – Investigate the root causes behind frequent operation of NGD devices at TPSS. Is this an indicator of systemic rail/accessible over-voltage or equipment issues? Carry out the necessary system level tests to investigate systemic rail/accessible voltage performance. Investigate if or how this may be contributing to stray current issues with the utilities. (This should be considered in conjunction with rail accessible voltage testing, Item 17 below.)
14. Stray Currents at Adjacent Utilities –Project Co, in collaboration with the stray current working group, develop and execute a remediation plan to correct the stray current issues reported by adjacent utilities. It was also recommended that Project Co respond to Mott MacDonald's request for stray current data submitted by RFI, although we note the current NCR #802 where stray current baseline and verification data to the PA has not been supplied. (See RFI log in Volume 7.)
15. Stray Current Monitoring – The reporting of excess stray current at some of the adjacent utilities as advised by the City of Ottawa, may suggest that some attention is required towards pro-active data collection and analysis of TPSS telemetry and reporting of stray current issues by adjacent utilities. While clear principles have been set out for this in

supporting design information within the grounding and bonding sub-system, the lack of data provided in response to Mott MacDonald's request for stray current monitoring data may suggest that not enough attention is being paid to gathering, analyzing, and acting upon data trends for stray current performance. (The existence of NCR #802 would reinforce this position.) For a network in early life operation, it should be expected that a footprint test has been completed at entry into operational service and within two years of entry into service. This data should be readily available.

16. Arcing event of 05-03-21 at LRV-1117/Parliament Station – In response to the arcing event of 05-03-21, Project Co carry out an analysis of clearance and the suitability of ground and bonding measures at the location of the event i.e., at Parliament Station. Have VLD-O devices been suitably deployed to manage electrical safety at the station locations? This issue has opened up the concerns Project Co has regarding high accessible rail volts. Mott MacDonald understands in response to this that Project Co has prioritized safety by closing the NGD at TPSS. This decision, while on balance is clearly the right one over the concerns noted, does have consequences in the form of promoting stray current leakage from the network. There is some evidence that this is already having impact on the adjacent utilities. We recommended that some urgency is placed on remediating over-voltage protection at critical human interfaces like stations so that the NGD are put back into normal operation at the earliest opportunity. (This should be considered in conjunction with rail accessible voltage testing below.)
17. System Performance for Rail Accessible Voltage and Grounding and Bonding Principles – Related to concerns with frequent operation of NGD at several TPSS around the network and recent concerns that Project Co has evidenced themselves regarding levels of rail voltage, we recommended that Project Co does some network wide testing to profile rail volts. This would need to be done with the NGD open and Mott MacDonald recognize that is problematic given the arcing event of 05-03-21 and concerns regarding over-volts protection. It may be necessary to provide remediation of over-volts protection at stations to ensure the safety of the public during this type of testing. The alternative would be to run a shadow service out of normal hours. Mott MacDonald suggest this testing is necessary (unless Project Co can provide data in lieu of this), as it will provide insights into system performance for rail volts, reasons for frequent NGD operation around the network, the arcing event at Parliament and rail voltage impact on stray current performance. It was also recommended that a wider review of grounding and bonding measures across the network is carried out.
18. TPSS06 Frame Leakage Faults –Project Co carry out a detailed review of insulation coordination at the TPSS06 dc switchgear panel to eliminate the relatively high number of high priority events that have resulted over frame faults. Noting that Project Co has eliminated protection equipment faults as the root cause, it is recommended that some limited inspection and insulation testing is carried out to resolve this issue. It was also recommended that Project Co investigate the high levels of moisture present in this substation, and also as noted in substation TPSS02, as being a contributory factor to this type of repeating event.

#### 4.2.2 Rail Systems – Other Recommendations

##### OCS/Section Insulators

19. It is recommended that all section insulators installation be checked and maintained in accordance with manufacturers instructions

##### 20. OCS/Balance Weight Anchors

- a. A survey of all the balance weight anchors should be carried out to determine the as-built configuration, with further inspections, including measurements of:

- i. The weight stacks from a fixed datum, not ground level as this can change over time.
- ii. The distance between the stop and pulley wheel. This is critical to the operation of the stop, to prevent the weights from crashing to the floor/high temperature stop, in the event of a wire failure.
- iii. Check wires on and off the pulley drums, especially for rubbing the sides of the pullies.
- iv. Check movement of the pullies.
- v. Ensure all defects are noted, including loose fixings.

21. It is reported, in the ALLTRADE/CYMI maintenance report that several U-bolts are rusty. If not already instigated, further inspections/investigation should be carried out to determine the extent of the corrosion and if they need to be replaced

#### Traction Power

22. It is recommended that Project Co confirm the actions they have taken to reduce the frequency of tripping events for TPSS switchgear.
23. It is recommended that Project Co review its grounding and bonding principles noting their own concerns relating to generally high accessible rail voltages around the network and the systemwide response to the arcing event at LRV-1117/Parliament Station.
24. It is recommended that Project Co review its stray current monitoring strategy, to establish a baseline and to resolve NCR #802 item. (Prior to this the network must be restored to normal operation. In this context we refer to restoring NGD devices at TPSS to normally open position.) It was also recommended that Project Co be consistent in carrying out periodic stray current monitoring and reporting in accordance with the Project Agreement.

#### GIDS

25. Further definition of requirements – including object speed and operational window
26. Providing details of installation, configuration and testing – including test pass/fail criteria, test cases and evidence of compliance with the design.
27. Review of the current installation and configuration against the further defined requirements so that the instances of “false positives” can be further reduced.

#### SCADA

28. Development alarm strategy that includes differentiation of events, indications, alarms.
29. Development requirements alarm management and handling.
30. Consultation with Users/Operators for the development of the alarm strategy, alarm management and handling requirements.
31. Agreement with Users/Operators who will be responsible for review events, indications (e.g. Operators) and who will be responsible for actioning alarms (e.g. Maintainers).
32. Root cause investigation of the highest three broad categories of alarms, including a review of the interfacing systems faults and configurations.
33. Engagement with Human Factors and Ergonomics to assess the volume of alarms, the type of alarms, the number of User/Operator workstations.



## 5 Recommendations – Volume 4

The following are the recommendations that Mott MacDonald suggest for consideration, after our review of the MSF and yard processes. The list below is grouped by priority to identify those tasks we recommend that Project Co undertake immediately and those which could be completed in the medium-term.

### 5.3 Priority Recommendations

1. Bypass Track – The bypass track (track 14) is not currently commissioned as its part of Stage 2, this appears to be an unnecessary constraint on the current movement of vehicles within the MSF site. It is recommended the introduction of this bypass track is considered since it could be used to facilitate the movement of vehicles in and out of the MSF at busy times such as when the fleet enters or returns from daily service. This could ease the operational constraints the current layout is creating by providing more flexibility.
2. Traction Power Grounding – The traction power for MSF 1 and the yard are powered through different supplies, the MSF 1 is grounded, and the yard is floated, causing a sudden rush of current, which causes the fuse to blow to protect the system. A temporary mitigation was proposed and implemented, by limiting train operation and bringing vehicles only through the west side of the Maintenance building. The Rectification Plan proposed a technical solution to replace the fused design with a new Stinger Panel. It is recommended that Project Co provide evidence that the solution was implemented, or a revised Rectification Plan indicating when the solution will be implemented.
3. Catenary Energization Warning Light – On track #7, the light fixture that indicates the status of the overhead catenary, falsely indicates a de-energized catenary when the catenary is energized. Under normal conditions, when the catenary is energized, the red light indication should be “on” and when the catenary is de-energized, the green light should be “on.” However, it was noticed that with the catenary energized, the green light was “on,” falsely indicating a de-energized catenary. Although RTM and Alstom personnel are aware of this situation, the issue has not been properly addressed. This is a potential safety hazard for other personnel that may not be aware of the issue, e.g., subcontractors, and as such, an investigation and proper solution should be implemented as soon as possible.
4. MSF Track Gauge – At several curves the track gauge is tight (i.e., less than 1435mm). To minimize the risk of derailment throughout those curves, it is recommended to adjust the track gauge by replacing the plastic spacers on the ties – similar to what has been done before on curves C18, C19 and C20.

### 5.4 Additional Recommendations

5. Shop Equipment – It is recommended the floor areas and available power supplies are assessed to ensure their suitability for conducting vehicle lifting activities (e.g., floor reinforcement).
6. Brake Inspection Process – It is recommended to determine the reasoning behind the decision to inspect the friction brake system on a daily basis, as modern LRVs typically do not require a daily inspection check unless there is an underlying need.
7. Corrective Actions – In order to provide supporting data and demonstrate that corrective actions put in place are having the desired effect it is recommended that Alstom be requested to submit sample measurements, new/worn tolerance values and inspection records for wheel truing, wheel wear recording, and flange lubrication as well as type/qualification tests for the new sand.

8. Flange Lube Equipment – It is recommended that Alstom review the procedure and the maintenance instructions related to the setting of the flange lubrication equipment following wheel truing and wheel replacement in order to ensure the alignment is related to the relevant wheel diameter and flange position. This may also require a formal re-training of staff to ensure they are aware of the process necessary to ensure the alignment is correct and made aware of the implications of incorrectly setting the flange lubricator spray nozzles.
9. Grease Application – In addition to the observations in the MSF, the presence of grease on the rail crown and wheel treads may be contributing to the known train stopping issues caused by overshooting. It is recommended to carry out a more detailed analysis of the process to apply the grease and possible consequences of applying grease manually in such quantity.
10. MSF WRI – The transposing of the two rails at the curve location in the yard, where the derailments have occurred, has been done to relocate the rail with the excessive side wear to the inside rail position in order to restore the track gauge. However, the track gauge could now be too tight resulting in the possibility of a repeat of previous problems leading up to the recent derailments. It is recommended to carry out a further analysis of the wheel rail interface at this location, including but not limited to comparing track gauge against bogie steering capability, wheel back-to-back dimensions, and wheel tread and flange profiles.
11. Camber Angle Assessment – In addition to the wheel/rail interface observations identified in recommendation #6 above, Alstom's proposed implementation of a fleet wide modification (reference: Design IPONAM T20) to the bogie axle beam to address the initial V5 design wheel camber misalignment (according to Alstom, this has an impact on the wheel back-to-back dimension), should be assessed further. It is unknown if the current camber angle and back-to-back dimension has any influence on the current wheel/rail interface in respect to the track gauge, rail wear, and potential wheel flange climb and derailment issues previously discussed in Section 3.4 above.
12. SIW Track Use – Due to the facility and yard limitations, the SIW track is used to launch vehicles for revenue service in the morning hours. It is important to note that this track was not designed for this purpose and as such this practice is not recommended as staff are likely to be working/walking within this building while train movements are taking place.

## 6 Recommendations – Volume 5

The list below is a summary of the recommendations made in this Volume 5, grouped by priority to identify those tasks we recommended that Project Co undertake immediately and those which could be completed in the medium-term.

Please note that many of our recommendations could impact the Project design, and so Project Co will need to agree with the recommendations made and provide design drawings/information/plans to implement the changes.

### 6.1 Revenue Vehicles - Priority

#### Backlog of Deferred Maintenance

1. It is recommended that an independent review of the long-term stopped and cannibalized vehicles, and associated materials/equipment is carried out as part of an overall asset condition assessment, as its likely these assets may deteriorate if left in an inoperable condition for long periods of time.
2. It is recommended that a detailed independent analysis be conducted of items of equipment suffering from premature failure.
3. It is recommended, possibly in conjunction with the items above, that an independent review is carried out in order to understand the root cause of the deferred maintenance backlog.

#### Vehicle CCTV

4. It appears there are remaining issues with the vehicle-to-station CCTV communication. As this system does not appear to be meeting the requirements of the PA, it is recommended to carryout a more detailed analysis of the system and any proposed mitigation measures to address the situation.

#### Wheel Flats

5. There have been discussions by Project Co about possibly reducing the EB deceleration rate; we recommended that any proposed braking rates must be carefully considered before any implementation is carried out.
6. It is recommended that the rate and magnitude of wheel flats, including the sanding system performance, needs to continually be observed and monitored.

#### Wheel Truing

7. Following wheel re-profiling the tread surface including flange should not have a coarse surface. A Good Industry Practice example calls for a surface roughness no coarser than 12.5 µm (N10). This also aligns with the wheel lathe OEM standard. It is recommended to review the current training of the wheel lathe operators, and associated operating procedures, in order to identify why the current machining process is producing a course surface finish.

#### Wheel Wear Recording

8. It is recommended to carry out a sample validation of the wheel diameters against what the wheel lathe is currently producing, as a review of the wheel truing records shows several anomalies. Any validation should be carried out using a calibrated measuring device to provide a comparison.
9. It is recommended to carry out a wheel profile validation check against what is being produced by the wheel lathe, including the hand measuring gauges used post wheel truing and for routine maintenance.

10. Wheel back-to-back dimension validation checks against what the wheel lathe is measuring should be carried out on a sample number of trucks/vehicles (e.g., 10%). The checks should include at least three equally distanced measurements around the back face of the wheel.
11. It is recommended to validate the wheel flange and tread profiles, and wheel diameters are being maintained in accordance with the relevant standards and Good Industry Practice.

### **Wheel Flange Lubrication System**

12. In addition to the one-off fleet check noted above, we recommended ensuring that the correct OEM requirements and any special tooling are available to the maintenance staff, and whether they have undergone the correct level of training to carry out the adjustments.
13. Checks should be carried out to confirm the correct alignment of the flange lubricator spray nozzles after all wheel reprofiling/changing is completed due to the wheel diameters being reduced/increased
14. The on-board lubricant reservoir needs to be monitored by Project Co to determine usage in order to determine the maintenance intervention timescales, as it is not recommended to run vehicles between maintenance intervals with no lubricant being applied, otherwise the flange/rail conditioning will be lost.

### **Abnormal Pantograph Carbon Wear/Damage**

15. It is recommended that Project Co produce a check list to include the recording of actual pantograph raising forces against the OEM values including tolerances, vehicle number, pantograph serial number, date of check and mileage when the carbons were replaced/last inspected and recorded, etc. These details should be recorded on a template as a record going forward and for all future pantograph inspections and related work adjustments. This will provide an historical reference for each vehicle, in order to determine if the raising force has changed and or to provide a record of any other pantograph related observations/concerns.
16. It is recommended that Project Co establish processes to create and capture the necessary data to provide traceability and continuity on how often a specific pantograph has been adjusted, how long it has run, and the magnitude of any adjustments and carbon replacements have been made. These processes should be continued until such time the issues have been reduced/eliminated to an acceptable level of risk. In some cases, it would be prudent to adopt some or all of the above as good practice and to be incorporated into the current maintenance requirements.
17. During the winter operating period, the vehicle pantographs are typically fitted with “winterized carbon strips” to help with current collection from the OCS when there is ice/snow accumulation on the contact wire. It is recommended the pantograph setting procedures are reviewed and revised accordingly as any out of tolerance upward force (less/more) could be a contributory factor to the known grooving/wear/damage issues being found on the pantograph current collectors.

### **Vehicle Braking**

18. It is recommended a review of these procedures associated with mechanical releasing individual friction brakes to determine that risks are being suitably managed.

### **On-board Sanding System**

19. During winter months, it is recommended to top-up the sand boxes and test the sanding system functionality daily prior to operating on the network.
20. It is recommended that the maintenance procedures be amended to require collection of necessary data to provide traceability and continuity on how often the sand boxes require refilling and by what amount, as this may also provide an indication whether the relevant sander is working or not.

21. Until such time that sand usage data is available to inform sand filling amounts/frequency, we recommended that the minimum sand level be increased to at least 50%.
22. Regular functionality checks of the sand hose heater operation should be carried out.
23. The usage of this sand needs to be monitored to evaluate any inconsistencies in sand usage, either too much, or too little, as these are indicators of the overall performance of the sanding system.

#### **LRV Daily Checklist**

24. We recommended that the LRV Daily Checklist is revised to ensure the tasks are broken down into a logical sequence for each area (e.g., cab, passenger areas, exterior) and multiple checks are separated into individual tasks to ensure each item is ticked off accordingly by the operator

#### **Mainline Derailments**

25. Following the derailment of LRV1119 in September 2021, Alstom have been unable to confirm the root cause of the wheel hub/bearing failure that led to the derailment. Currently, Mott MacDonald are aware this is still the case. While many details related to the investigation findings, observations, and proposed mitigations have been provided by Alstom, however, there is no reference to the related wheel bearing housing modifications presented by Alstom in their presentation, *OTT LRT Axle Spline Connection*, June 30th, 2021, which was prior to the derailments. The purpose of these modifications is to reduce the risk of spline shaft wear which may lead to a complete loss of drive between two wheels of a wheelset. While there is no known evidence to suggest these modifications are related, it is recommended they are considered as part of the investigation, even if just to confirm there is no relationship between a potential spline failure and subsequent overheating of the bearing assembly, that may have contributed to the ultimate failure.
26. It is recommended that Alstom provide an update on the September 2021 derailment investigation, including feedback on the current mitigation measures that had been put in place as part of the Return to Service Plan.

## **6.2 Revenue Vehicle – Additional Recommendations**

It is recommended that:

27. Project Co assess the deferred vehicle maintenance list and develop a strategy for dealing with this backlog, in a prioritized manner. Outstanding deferred maintenance items, including safety critical and reliability related deferred items, as well as outstanding modifications, should be listed on a vehicle-by-vehicle basis to identify the level of effort required to return each vehicle to operational service, and a simple system used to catalogue each vehicle's repair priority and status.
  - a. In the short-term, that Project Co conduct a focused inspection on known issues with equipment on the LRVs. This should include, at minimum:
28. The functionality of the on-board sanding system and new sand type needs to be confirmed against the OEM specification requirements.
29. The new sand type needs to be confirmed with the MSF sand dispensing system OEM to ensure there are no compatibility issues.
30. Until such time the rail corrugation has been addressed, we recommended that additional truck and truck-mounted equipment and running gear inspections be carried out; this is necessary to mitigate the risk of components detaching and falling from the vehicle, as this has already occurred with the speed sensors and flange lubrication equipment.
31. A one-off check and correction adjustment of the flange lube nozzles, in accordance with the OEM requirements.



32. Project Co select a vehicle and install new pantograph carbon strips and paint the horns and leading/trailing carbon faces in a bright colour such as yellow. Once installed, check and record the upward force value in accordance with the correct OEM process including using a suitable measuring device (e.g., spring balance). Record both the pre- and post-adjustment values on the relevant record template. Install a temporary CCTV camera on the vehicle roof in order to record and view the operating range and performance of the pantograph, and take the vehicle around as much of the MSF as is possible, then return the vehicle to the roof inspection bay and carryout a visual inspection of the carbons and horns in order to identify if there is any damage (e.g., chipping of carbons) and/or scrapes to the yellow painted surfaces. Record all findings and observations on the record template.
33. A similar exercise to above should be carried out around the complete network by undertaking one round trip and then return the vehicle to the MSF to inspect, measure and record all findings and observations. Depending on the findings it may be necessary to repeat the process again until its possible to breakdown the areas on the network where potential interface issues may be occurring.
34. In the longer term, that Project Co adjust their maintenance practices to create the necessary data to provide traceability and continuity on how often assets have been adjusted, how long they have run, and the magnitude of any adjustments and replacements have been made, and apply a proactive approach to asset management.

## 7 Conclusion

As noted earlier, it is Mott MacDonald's assessment that the changes proposed in Project Co's Rectification Plan will be positive. Our report proposes mitigations to additional issues which we have noted, and together, if implemented, these are likely to further improve System performance.

In the longer term, we believe that Project Co should adjust their maintenance practices to gather and track the necessary data to provide traceability and continuity on how often assets have been adjusted, how long they have run, and the magnitude of any adjustments and replacements made. This data should be maintained through the lifecycle of the project and used to apply a proactive approach to maintenance and asset management.

# **Volume 7: Appendices**

April, 2022  
Confidential

# Contents

|    |                                     |     |
|----|-------------------------------------|-----|
| A. | Mott MacDonald RFI Log              | 207 |
| B. | Section References                  | 218 |
| C. | OCS - Height and Stagger Comparison | 221 |
| D. | Videos – OCS Observations           | 231 |
| E. | Balance Weight Assembly – 105+589   | 242 |

# A. Mott MacDonald RFI Log

| RFI Ref | Date Raised | Discipline/s       | Status | Description  | Stage Required    | Resolution   | Date Responded | Date Resolved | Comment                           |
|---------|-------------|--------------------|--------|--|-------------------|--|----------------|---------------|-----------------------------------|
| RFI 000 | 2020 07 27  | Various            | Closed | Information Requested in the proposal: <ul style="list-style-type: none"> <li>• Project Agreement and project specification requirements for each area;</li> <li>• List of RTG's Contract Deliverables to identify what was required and what has been delivered;</li> <li>• RTG's Integration Matrix and any supporting documentation;</li> <li>• RTG's Issues list and Risk Register;</li> <li>• RTG's Traceability Matrix potentially any lower level derived specifications (if possible) and select verification/validation (analysis, testing, etc.) documents;</li> <li>• RTG's Interface Control Document (or similar);</li> <li>• Design and construction information: IFC Drawings, Specification, Field Changes, Quality Records, and record drawings;</li> <li>• RTG's maintenance plans; and</li> <li>• Documentation relevant to known failures/issues and RTG's Rectification Plans.</li> </ul>                 | Background Review |  | various        |               | also provided access to E-Builder |
| RFI 001 | 2020 08 05  | Various            | Closed | Further information requested Aug 5th:and Vehicle as a priority); <ul style="list-style-type: none"> <li>• Incidents log(s);                             <ul style="list-style-type: none"> <li>o TOCC Event Log</li> <li>o RTG Work Order Logs / OCT Work Order Spreadsheet (raw data)</li> <li>o TOCC event-based e-mails</li> <li>o Performance Summary Reports (Antoine)</li> </ul> </li> <li>• PA Schedule 14 (Commissioning Schedule); and                             <ul style="list-style-type: none"> <li>o Trial Running Plan</li> <li>o RSA Term Sheet</li> <li>o Testing &amp; Commissioning Plan</li> </ul> </li> <li>• Substantial Completion information, namely:                             <ul style="list-style-type: none"> <li>o Substantial Completion Certificate;</li> <li>o Independent Certifier Substantial Completion documentation; and</li> <li>o Minor Deficiency List.</li> </ul> </li> </ul> | Background Review |  | various        |               | also provided access to E-Builder |
| RFI 002 | 2020 08 07  | Track              | Closed | Track & alignment design criteria, either prepared by RTG or City of Ottawa.   | Background Review | Provided   | 2020 08 10     |               |                                   |
| RFI 003 | 2020 08 10  | Track and Vehicles | Closed | Corrugation related information such as <ul style="list-style-type: none"> <li>• The specific locations that the rail corrugation issues are occurring (stationing/chainage; along with any localized geometry, or constraints such as areas of heavy braking in the vicinity).</li> <li>• Any measurements – frequency and depth of corrugation.</li> <li>• Any photos.</li> <li>• Confirmation of the design speeds, and required speed restrictions that have been set (if they are not in the design criteria you uploaded today).</li> </ul>  | Interim Report #1 | provided videos 2020 08 21. Provided Project Co corrugation field reports after MM site visits | various        |               |                                   |



| RFI Ref | Date Raised | Discipline/s | Status | Description   | Stage Required    | Resolution                        | Date Responded | Date Resolved | Comment                           |
|---------|-------------|--------------|--------|---|-------------------|-----------------------------------|----------------|---------------|-----------------------------------|
| RFI 004 | 2020 08 16  | Vehicles     | Closed | Vehicle Information: <ul style="list-style-type: none"> <li>Alstom Citadis Technical Description document. Please note this is typically produced by the vehicle supplier for each specific contract and includes a general technical overview of each of the key systems and equipment for the vehicle design being provided.</li> <li>Alstom Compliance Statement against the PA requirements, and any relevant validation evidence to support their statements.</li> <li>Auxiliary Power System Design Review</li> <li>TCMS Proposal / TCMS Management Plan (before current upgrade to reduce HSCB issues)</li> <li>TCMS revision/upgrade (TCMS 1.2.5.12, this was referenced in the Alstom Executive Update 20200610 PDF)</li> </ul>  | Interim Report #1 |                                   | 2020 08 19     |               |                                   |
| RFI 005 | 2020 08 22  | OCS          | Closed | OCS Information: <ul style="list-style-type: none"> <li>OCS;</li> <li>Traction Power;</li> <li>Signals &amp; Train Control System;</li> <li>Tunnel Ventilation System;</li> <li>Guideway Intrusion Detection System;</li> <li>PA and Passenger Information System;</li> <li>SCADA;</li> <li>CCTV;</li> <li>Network Backbone.</li> </ul> Also, any reports of incident investigations, records of remedial actions.<br><br>With the current specific focus on the OCS, we would need the following as the next action item: <ul style="list-style-type: none"> <li>OCS Design Criteria</li> <li>OCS Design Brief (and Specifications)</li> <li>OCS Shop Drawings and Vendor Documentation (very little on the Design Drawings set we got so far)</li> <li>OCS Installation Manual</li> <li>OCS Maintenance Manual</li> </ul> | Interim Report #1 | also provided access to E-Builder | 2020 08 20     |               | also provided access to E-Builder |
| RFI006  | 2020 08 28  | Vehicles     | Closed | Vehicle Reliability Reports for May, June and July 2020   | Interim Report #1 |                                   | 2020 09 01     | 2020 09 01    |                                   |
| RFI 007 | 2020 09 04  | OCS          | Open   | ADD000038945 REV 0 ; the document is reference in the RES-54-0-0000-DRD-2281 "OVERHEAD CATENARY SYSTEM - PANTOGRAPH SECURITY & - STEADY ARM CLEARANCES"   | Interim Report #1 |                                   |                |               |                                   |
| RFI 008 | 2020 09 25  | Rail Systems | Closed | System data <ul style="list-style-type: none"> <li>the confirmation of the 3 outage period they have had this year (dates and reason) to better understand remedial actions taken so far.</li> <li>Incident logs for End of August and September</li> </ul>   | Interim Report #1 | Incident logs provided            | 2020 10 01     |               |                                   |

| RFI Ref | Date Raised | Discipline/s              | Status | Description  | Stage Required    | Resolution | Date Responded | Date Resolved | Comment   |
|---------|-------------|---------------------------|--------|--|-------------------|------------|----------------|---------------|---|
| RFI 009 | 2020 10 01  | Vehicles                  | Open   | Vehicle information. <ul style="list-style-type: none"> <li>• Please confirm that an "H-bridge" is the motor overcurrent door obstruction protection system. Both terms have been used.</li> <li>• Has Alstom changed the sensitivity or threshold of the H-bridge?</li> <li>• The sensitive edge strips have been replaced. This should have eliminated dead zones. Has the sensitivity also been changed?</li> <li>• What were the changes on how a door can be reset after door obstruction fault count has locked a door out?</li> <li>• What were the changes in door cut-out process (both SOP &amp; physical/functional process)</li> <li>• Confirm door open dwell time changed from 12 to 20seconds.</li> </ul>   | Interim Report #1 |            |                |               | May not have been tracked as was not issued via "single point of contact" |
| RFI 010 | 2020 10 05  | Vehicles and Rail Systems | Open   | Various <ol style="list-style-type: none"> <li>1. Vehicle inspection Manual/Procedure                             <ul style="list-style-type: none"> <li>• OTT-LRV-MTN10-WMS-001 Weekly Inspection</li> <li>• OTT-LRV-MTN10-WMS-002 25,000 km Inspection:</li> <li>• OTT-LRV-MTN10-WMS-003 30,000 km Inspection</li> <li>• OTT-LRV-MTN10-WMS-004 50,000 km Inspection</li> <li>• OTT-LRV-MTN10-WMS-005 100,000 km Inspection –Year 1:</li> <li>• OTT-LRV-MTN10-WMS-017 150,000 km Inspection:</li> <li>• OTT-LRV-MTN10-WMS-006 200,000 km Inspection -Year 2:</li> <li>• OTT-LRV-MTN10-WMS-007 300,000/330,000/375,000 km Inspection -Year 3:</li> <li>• OTT-LRV-MTN10-WMS-008 400,000 km Inspection -Year 4:</li> <li>• OTT-LRV-MTN10-WMS-009 500,000 km Inspection -Year 5:</li> <li>• OTT-LRV-MTN30-WMS-003 Daily LRV Inspection:</li> </ul> </li> <li>2. Sample Vehicle Preventative Maintenance Report for Vehicle witnessed in the MSF (LRV1118 &amp; LRV1124)</li> <li>3. History/Summary of vehicle maintenance, when they were in the shop, and for which type of maintenance</li> <li>4. OCS inspection Manual/Procedure                             <ol style="list-style-type: none"> <li>a. Visual Environment OCS inspection OTT-OCS10-MTN10-WMS-007</li> <li>b. OCS Specific InspectionOTT-OCS10-MTN10-WMS-001</li> <li>c. OCS Height and Stagger control –Track TracerOTT-OCS10-MTN10-WMS-003</li> <li>d. OCS Tensioning devices and Fixed Terminals InspectionOTT-OCS10-MTN10-WMS-002</li> <li>e. OCS InspectionOTT-OCS10-MTN10-WMS-005</li> <li>f. Grounding &amp; Bonding SystemOTT-OCS10-MTN10-WMS-004</li> <li>g. YODS/MODSElectrical InspectionOTT-OCS10-MTN10-WMS-006</li> <li>h. OCS Contact Wire diameterCtrlOTT-OCS10-MTN10-WMS-008</li> </ol> </li> <li>5. Substation current logs for TPSS08 for the months of May to August 2020. (there is a pattern of excessive heating from the incident logs)</li> </ol> | Interim Report #2 |            |                |               |   |

| RFI Ref | Date Raised | Discipline/s              | Status | Description   | Stage Required    | Resolution | Date Responded | Date Resolved | Comment |
|---------|-------------|---------------------------|--------|---|-------------------|------------|----------------|---------------|---------|
| RFI 011 | 2020 10 06  | Vehicles                  | Open   | Vehicle-related information <ul style="list-style-type: none"> <li>• The vehicle on-board sanding test procedure, including the actual sand specification of the original sand and the new sand, assuming this is to the OEM specification? Please note that the Original Equipment Manufacturer we are referring to in this case is the supplier of the on-board vehicle sanding equipment. If the new sand is not recommended by them then we need to know what this specification is.</li> <li>• The pantograph maintenance and overhaul manual from the OEM.</li> <li>• Wheel data, including the following:                             <ul style="list-style-type: none"> <li>o Wheel flange height and thickness, including new and worn values and tolerances.</li> <li>o Wheel diameter tolerance difference between wheels on the same axle.</li> <li>o Wheel diameter tolerance difference between wheelsets on the same truck.</li> <li>o Wheel diameter tolerance difference between different trucks. Note, typically there is no tolerance limit between trucks, but this needs to be confirmed one way or the other.</li> <li>o Wheel back-to-back dimension including tolerances.</li> <li>o What is the level of machining finish (coarseness) for the wheels, post truing.</li> <li>o What is the maximum permitted size of wheel flat before wheel truing is required.</li> <li>o Confirmation if the wheel truing machine can automatically measure and record any of the following:                                     <ul style="list-style-type: none"> <li>§ wheel diameters</li> <li>§ flange height/thickness</li> <li>§ wheel back-to-back dimensions prior to and post wheel truing.</li> </ul> </li> <li>§ If any of the above wheel measurements can't be measured and recorded by the wheel truing equipment, please advise how these are measured by the maintainer.</li> </ul> </li> </ul> | Interim Report #2 |            |                |               |         |
| RFI 012 | 2020 10 07  | Vehicles and Rail Systems | Open   | Information: <ul style="list-style-type: none"> <li>• Negative Grounding Device Trip Event log for September and October</li> <li>• Negative Grounding Device Short term and Long Term Setting: Initial at Commissioning and Actual adjusted now</li> <li>• Negative bus voltage recording and Substation current recoding for TPSS 1 on a day where NGD trip event are recorded.</li> </ul> Confirmation of the traction power system configuration at that time (switch position) <ul style="list-style-type: none"> <li>• Training evidence for ground clamps installation on rigid rail.</li> <li>• Signs intended to be installed for signaling rigid rail ground clamps.</li> <li>• Evidence of installation of additional ground clamps locations on rigid rail.</li> <li>• Evidence of replaced HVAC on TPSS 8 and others (date, action)</li> <li>• Vehicle Sanding system sand specification</li> <li>• Specification of the latest sand purchased</li> </ul>  | Interim Report #2 |            |                |               |         |

| RFI Ref | Date Raised | Discipline/s              | Status | Description   | Stage Required    | Resolution  | Date Responded | Date Resolved | Comment |
|---------|-------------|---------------------------|--------|---|-------------------|---|----------------|---------------|---------|
| RFI 013 | 2020 10 16  | PA                        | Closed | <p>Could you please provide us with copies of Project Co's Performance Monitoring reports for the period from September 2019 to September 2020 (or whatever are the latest available)? We did not see them on E-Builder.</p> <p>We want to use them to assess Project Co's calculation of :</p> <ul style="list-style-type: none"> <li>• any Service Failures and associated Service Failure Points, in respect of that month;</li> <li>• any Quality Failures and associated Quality Failure Points in respect of that month; and</li> <li>• total of all Failure Points assigned due to Station Availability Failure and/or Vehicle Availability Failure.</li> </ul>  | Interim Report #2 |   | 2020 10 26     |               |         |
| RFI 014 | 2020 10 19  | Vehicles and Rail Systems | Open   | <p>Could we please request the following documents? We cannot seem to find them on E-Builder.</p> <p>Maintenance/Procedure:</p> <ul style="list-style-type: none"> <li>• TPSS Visual Inspection OTT-TPS10-MTN10-WMS-001</li> <li>• TPSS Cleaning and SCADA remote testing OTT-TPS10-MTN10-WMS-003</li> <li>• Fire Detection System Inspection OTT-TPS10-MTN10-WMS-004</li> <li>• TPSS Annual inspection OTT-TPS10-MTN10-WMS-002</li> <li>• Feeder Cables Insulation tests OTT-TPS10-MTN10-WMS-005</li> </ul> <p>Operation and Maintenance Manuals (similar to the one for track)</p> <ul style="list-style-type: none"> <li>• Traction Power Substations</li> <li>• Overhead Catenary System</li> <li>• Comms/SCADA/Network</li> <li>• Signaling System (Thales CBTC)</li> <li>• Alstom Citadis Vehicle</li> </ul> <p>Protective Device Coordination and Relay Setting Study (Traction Power)</p> | Interim Report #2 | Update 2020 11 01 -Signalling sytem Thales CBTC has been provided |                |               |         |
| RFI 015 | 2020 10 29  | Yard                      | Closed | <p>Derailment Report</p> <p>Could the City also let us know:</p> <ul style="list-style-type: none"> <li>• When and where was the first derailment?</li> <li>• When and where was the de-wiring in the yard?</li> </ul>  | TBC               | Provided Derailment Report  | 2020 10 30     |               |         |

| RFI Ref | Date Raised | Discipline/s              | Status | Description  | Stage Required    | Resolution  | Date Responded | Date Resolved | Comment |
|---------|-------------|---------------------------|--------|--|-------------------|---|----------------|---------------|---------|
| RFI 016 | 2020 11 01  | Track                     | Open   | <p>Files:</p> <ul style="list-style-type: none"> <li>• Bogie Weight Balance [14/01/2013] NBE-01-00055780_B.xl</li> <li>• SIMPACK Model Parameters IPONAM_404_ipBuilder_v1_ind11_2014-12-01.xlsm</li> </ul> <p>Questions:</p> <ul style="list-style-type: none"> <li>• Wheel truing history for vehicles - number of times, distance between truing, reason for truing?</li> <li>• Primary yaw stiffness of the motor and trailer truck.</li> <li>• Un-sprung mass of the motor and trailer truck.</li> <li>• Operating speeds of the vehicles from the CBTC system</li> </ul> <ul style="list-style-type: none"> <li>• It is believed that grinding of the line has been carried out once in 2019. What was the reason for grinding? What was the target profile?</li> <li>• Rail pad stiffness for the ties used on the ballasted track.<br/>Information on the ballasted track support stiffness.<br/>If a rail pad used on the direct fix fasteners it is not clear on the drawings, is it the same as the ties?</li> <li>• Have the measurements in the JBA Project Co Braking Strategy (wheel flats report issue) 1.0 final, section 7.3 been undertaken?- "It is intended to use a specialist consultant to attend these locations and assess the friction of the railhead and other conditions in May 2020."</li> </ul> | Final Report      |   |                |               |         |
| RFI 017 | 2020 11 01  | PA                        | Closed | IOS failure code descriptions  | Interim Report #2 |   | 2020 11 02     |               |         |
| RFI 018 | 2020 11 03  | Vehicles                  | Open   | Line Inductor Failure Analysis Report Doc # DED0000 Rev A shall be issued to the City as will Failure analysis report LINE INDUCTOR DTR0000377985 Doc # AYD0000561716  | Interim Report #2 | 2020 11 18:<br>Received reliability reports for Aug and Sept 2020   |                |               |         |
| RFI 019 | 2020 11 06  | SCADA                     | Open   | System Integration Management Plan' (SIMP) and the 'Human Factors Management Plan'.  | SCADA Workshop    |   |                |               |         |
| RFI 020 | 2020 11 06  | CBTC                      | Open   | <p>A log with all software updates performed by Thales during last year:</p> <ul style="list-style-type: none"> <li>o Date of update</li> <li>o Related system (e.g. VOBC, ZC...)</li> <li>o Update details – what was fixed, software version, etc.</li> </ul>  | Interim Report #2 |   |                |               |         |
| RFI 021 | 2020 11 12  | Vehicles and Rail Systems | Closed | <p>Could we please have confirmation if the Revised RTG Remedy/Rectification Plan dated 25 April 2020 is still current, and if there has been any recent update on where the schedule for each of the issues is currently?</p> <p>Also, can we please advise whether Project Co is conducting their own trend analysis to determine how the rectification plan is looking in terms of service affecting failures/faults, and if so can we please get a copy?</p>   | Interim Report #2 | RP is still current, no City not aware of any trend tracking by PCo |                |               |         |

| RFI Ref | Date Raised | Discipline/s   | Status | Description   | Stage Required | Resolution      | Date Responded | Date Resolved | Comment |
|---------|-------------|----------------|--------|---|----------------|-----------------|----------------|---------------|---------|
| RFI 022 | 2020 11 15  | Traction Power | Open   | Two parts to this RFI:<br>1) We have been reviewing the results of the OCS line voltage tests. Can we please ask for a detailed listing of the input parameters to the test, as well as a more legible summary of the test outputs.<br>2) Moisture in tunnels can be a major contributory factor for poor stray current performance in a dc traction power network, because when the rail to earth impedance is not maintained to a reasonable level stray current flows and stray current corrosion results over time. Because of the weather conditions in Ottawa we are interested in understanding how well the system is performing from a stray current perspective. The system has a level of automated stray current monitoring which is likely supplemented by periodic manual testing. In early operation we would imagine that RTG will be reporting on stray current performance. They should be monitoring at some of these vulnerable structures.<br>Accordingly, could we please request the latest stray current monitoring test report? Preferably this would cover winter 19/20 and spring/summer 20. | Final Report   |                 |                |               |         |
| RFI 023 | 2020 12 10  | CBTC           | Closed | Can we please have the event logs after 8 August 2020 and until recent weeks. This will help us understand whether the Thales software upgrade (to version 6.1) improved the situation compared to what was noted in the letter of April 24.  | City of Ottawa | Received Dec 14 | 2020 12 14     |               |         |



| RFI Ref | Date Raised | Discipline/s   | Status | Description   | Stage Required | Resolution | Date Responded | Date Resolved | Comment |
|---------|-------------|----------------|--------|---|----------------|------------|----------------|---------------|---------|
| RFI 024 | 2020 12 15  | Traction Power | Open   | 1. Please provide power system verification and validation reports (we wish to review whether there were any indicators of out of tolerance rail voltages recorded).<br>current logs for TPSS 06 and 07   | City of Ottawa |            |                |               |         |
| RFI 025 | 2021 02 25  | Vehicles       | Open   | " Mott MacDonald's resident vehicle inspector requires documentation of agreed procedures and protocols, to facilitate their ongoing review of whether key issue mitigation works/modifications have been completed/working. Accordingly, please provide:<br><br>1. Alstom's list of open items for LRV51<br>2. Alstom's list and status of modifications completed on LRV51<br>3. Alstom's NCR list for LRV51<br>4. Alstom's list and procedures of agreed statical functional tests to be performed during pre-shipment inspection<br>5. Alstom's description and technical documentation (reports, As-built drawings, agreed solutions, etc.) of the following issues affecting revenue service:<br>a. Manual brake release functionality<br>b. Air supply system – modification to the tank reservoir components<br>c. Driver Cab Onboard Monitor for Wayside CCTV systems (platform edge views) (incomplete)<br>d. Removal of wheel jacking screws prior to vehicles entering service" | City of Ottawa |            |                |               |         |

| RFI Ref | Date Raised | Discipline/s   | Status | Description  | Stage Required | Resolution | Date Responded | Date Resolved | Comment   |
|---------|-------------|----------------|--------|--|----------------|------------|----------------|---------------|---|
| RFI 026 | 2021 03 05  | Vehicles       | Open   | <p>"In order to facilitate Mott MacDonald's review of MSF yard processes, can the City please ask RTG to provide the following information:</p> <ul style="list-style-type: none"> <li>the overall maintenance strategy plan</li> <li>the vehicle specific strategy plan (if there is a separate one), and</li> <li>any documentation which might further describe the "routine" of maintenance through the day and week (again if there is any) (for instance there may be a document, procedure, or outline which describes when the vehicles are washed, as one example)."</li> </ul> | City of Ottawa |            |                |               | production charts are being provided on a regular basis |
| RFI 027 | 2021 04 30  | Traction Power | Closed | <ol style="list-style-type: none"> <li>Please provide any information related to the arcing event with LRV-117</li> <li>In addition please provide any information available related to excess stray current being experienced by local utilities in their infrastructure</li> </ol>   | City of Ottawa |            | 2021 04 30     |               |   |

| RFI Ref | Date Raised | Discipline/s | Status | Description   | Stage Required | Resolution         | Date Responded | Date Resolved | Comment |
|---------|-------------|--------------|--------|---|----------------|--------------------|----------------|---------------|---------|
| RFI 028 | 2021 07 16  | Vehicles     | Open   | LRV information prior to site visit see email TYW to Alanna L 2021 07 16                                | City of Ottawa |                    |                |               |         |
| RFI 029 | 2021 08 12  | PA Review    | Closed | Could we please have the most recent Monthly Performance Reports from Project Co (since February 2021)? | City of Ottawa | Provided 2021 0812 | 2021 08 12     | 2021 08 12    |         |

| RFI Ref | Date Raised | Discipline/s | Status | Description   | Stage Required | Resolution | Date Responded | Date Resolved | Comment |
|---------|-------------|--------------|--------|---|----------------|------------|----------------|---------------|---------|
| RFI 030 | 2021 08 12  | WRI          | Open   | Various information required for WRI see email TYW to AL 2021 08 12 20:53 | City of Ottawa |            |                |               |         |

## B. Section References

Reference documents used by Mott MacDonald through assessment and review are noted below, and marked by specific section within the preceding report.

### Traction Power Review

1. Original project requirements (“output specification”) – reference Ottawa Light Rail Transit Project, Schedule 15-2 Part 4 to Project Agreement, Execution Version
2. Rectification Notice – City of Ottawa letter reference OTT-RTG-LET-0308 dated 11 March 2020
3. Response to Rectification Notice – RTG letter reference RTG-OTT-00-0-LET-0938 25 April 2020
4. Incident, Event and SCADA Logs Aug 2019 – Jan 2020, Jan 2020 – Jun 2020, September 2020 - October 2020.
5. Alstom Infrastructure Facility Inspection Report. (Alstom, Laurence Gouteron, 20-Jan-2020)
6. Systemwide Power Distribution Final Design Review Report (RES-56-0-0000-REP-0093)
7. Grounding and Bonding Design Report (RES-56-0-0000-REP-02621\_0)
8. OLRT Sectionalizing Diagram (RES-54-0000-DRD-2000).
9. Verification and Validation test report. (OLR-16-0-0000-MAN-0001)
10. Works Order Files Dated 30.06.2020 to 02.09.2020
11. Shop drawings for TPSS modules. (TPSS4 and MSF as exemplar).
12. Mitigation and Monitoring of DC Stray Current Interference Effects (REJ-56-0-0000-REP-0125)
13. Original project requirements (“output specification”) – reference Ottawa Light Rail Transit Project, Part 1 – Article 14 to Project Agreement, Execution Version.
14. Technical Data submitted to Mott MacDonald 29.04.21 - Email – Enbridge Gas Utilities to City of Ottawa 18.03.2021 – Stray Current on Gas Utilities suspected source being the OLRT.
15. Technical Data submitted to Mott MacDonald 29.04.21 – Details of Arcing event of 05.03.21 and email chain regards subsequent closure of all NGD as a result of this

### GIDS and SCADA

1. Original project requirements (“output specification”) – reference Ottawa Light Rail Transit Project, Schedule 15-2 Part 4 to Project Agreement, Execution Version
2. Rectification notice – City of Ottawa letter reference OTT-RTG-LET-0308 dated 11 March 2020
3. Response to Rectification Notice (rectification plan) – RTG letter reference RTG-OTT-00-0-LET-0938 25 April 2020
4. Incident log – May to August 2020, file CAD\_TOCC\_L1\_Log\_May\_Aug\_2020.XLS
5. Typical SCADA system logs (as example) – for 24 hours of 11 October 2020
6. Typical failure points work orders (as example) – received early November 2020

7. Intrusion system design – intrusion access control system, final design report, reference RES-53-0-0000-REP-0159, revision 0, 10 June 2016
8. SCADA design – final design report, reference RES-53-0-0000-REP-0222, revision 1, 15 July 2016
9. Station communications design drawings – various references, designed by SNC Lavalin, as-built, circa August 2017
10. SCADA as-built documentation – provided by Willow Glen Systems, circa 2017
11. Completion logs – completion manual, communications systems, reference OLR-16-0-0000-MAN-0002, revision 0, 22 April 2019\*
12. Informal discussions with the City of Ottawa and Mott MacDonald relating to the GIDS and SCADA system between October 2020, March and April 2021
13. OLRT-C Systems Engineering Management Plan, reference OLR-50-0-0000-MPL-0005, revision 0, 21 February 2018
14. September 2020 Ottawa Reliability Report, 29 October 2020
15. Guideway Intrusion Detection System (GIDS), Final Design Review, reference OLR-50-0-0000-REP-0003, revision 1, 31 October 2017
16. System Integration Testing for SCADA / stations and systems, reference RES-16-4-MEAB-SIT-5R2038, 14 December 2020
17. (SCADA handover documentation pack from Willowglen Systems, February 201)
18. (GIDS activation data between 16-Sep-21 and 03-Mar-21).

*Note – only information deemed relevant to GIDS and SCADA is listed above.*

### CBTC

1. Original project requirements (“output specification”) – reference Ottawa Light Rail Transit Project, Schedule 15-2 Part 4 to Project Agreement, Execution Version
2. Rectification notice – City of Ottawa letter reference OTT-RTG-LET-0308 dated 11 March 2020
3. Response to Rectification Notice (rectification plan) – RTG letter reference RTG-OTT-00-0-ET-0938 dated 25 April 2020
4. Incident log – September 2019 to May 2020, file Rail Log Full Sept 2019 to May 2020.xls
5. Incident log – May to August 2020, file CAD\_TOCC\_L1\_Log\_May\_Aug\_2020.xls
6. Incident log – August to December 2020, file L1\_Rail\_Log\_Aug\_Dec\_2020.csv
7. Automatic Train Control (ATC) System User Guide – reference Thales 3CU 05018 0002 PCZZA revision 007 dated 21 September 2020
8. Train Operator User Guide – reference Thales 3CU 05018 0006 PCZZA revision 006 dated 21 September 2020
9. MSC Monthly Reliability & Maintainability Report Alstom Ottawa LRT Maintenance, quarterly copies for January, April, July, October 2020 and for January 2021

### Line Inductor (Roof Flashovers)

1. Request for Documentation - Rolling Stock Documentation\_DED0000 - Line Inductor Failure analysis report\_Rev A
2. MTNMTN-TLOTT-WMS-003 - Citadis Spirit Vehicle Operating Manual\_Rev E



3. DTD0000099943\_--C\_CATDRAWING\_1 to  
4\_CITADIS\_SPIRIT\_OTTAWA\_LAYOUT\_49M\_120\_SEATS
4. AYD0000561716 - LINE INDUCTOR DTR0000377985
5. ADD0000939545 Alstom Propulsion System Ottawa
6. ADD0000939481\_DR\_Basic design parameters-revB
7. 5. Alstom Executive Update 20200610 OCT-ALSTOM Meeting
8. 1. RTG Rectification Plan RTG-OTT-00-0-LET-0938 - RTG Revised Plan (R1)
9. Copy of Disruption\_Log\_Expanded\_Dec\_2020\_Jan\_2021

#### Line Contactor

1. Rolling Stock Documentation\_DED0000 - Line Inductor Failure analysis report\_Rev A
2. RTG Rectification Plan RTG-OTT-00-0-LET-0938 - RTG Revised Plan (R1)

#### Auxiliary Converter (APS)

1. MTNMTN-TLOTT-WMS-003 - Citadis Spirit Vehicle Operating Manual\_Rev E
2. ADD0000939545 Alstom Propulsion System Ottawa
3. ADD0000939481\_DR\_Basic design parameters-revB
4. Alstom Executive Update 20200610 OCT-ALSTOM Meeting
5. RTG Rectification Plan RTG-OTT-00-0-LET-0938 - RTG Revised Plan (R1)
6. Copy of Disruption\_Log\_Expanded\_Dec\_2020\_Jan\_2021
7. OLRT - Scope 5 - Schedule 15-2 Part 4 Vehicle Requirements
8. Alstom's CVS SPIRIT SW C14\_Evolution\_200306 v3

#### High-Speed Circuit Breaker

1. MTNMTN-TLOTT-WMS-003 - Citadis Spirit Vehicle Operating Manual\_Rev E
2. ADD0000939545 Alstom Propulsion System Ottawa
3. ADD0000939481\_DR\_Basic design parameters-revB
4. Alstom Executive Update 20200610 OCT-ALSTOM Meeting
5. RTG Rectification Plan RTG-OTT-00-0-LET-0938 - RTG Revised Plan (R1)
6. Copy of Disruption\_Log\_Expanded\_Dec\_2020\_Jan\_2021
7. OLRT - Scope 5 - Schedule 15-2 Part 4 Vehicle Requirements

#### Passenger Doors

1. Alstom Door Software Update AT Ottawa - Fault #12 management - October 2019 v6
2. RTG Rectification Plan RTG-OTT-00-0-LET-0938 - RTG Revised Plan (R1)

## C. OCS - Height and Stagger Comparison

### Eastbound Heights and Staggers

| Str No    | Stationing | As-built<br>CW Ht<br>m | As-built<br>Stagger<br>m | After<br>Rectification<br>CW Ht<br>m | After<br>Rectification<br>Stagger<br>m |
|-----------|------------|------------------------|--------------------------|--------------------------------------|--|
| S1-E-1-5  | 98+147.500 | 4.168                  | 0.020                    | 4.168                                | 0.020                                  |
| S1-E-1-6  | 98+170.000 | 4.196                  | 0.030                    | 4.196                                | 0.030                                  |
| S1-E-1-7  | 98+206.869 | 4.199                  | 0.120                    | 4.199                                | 0.120                                  |
| S1-E-1-10 | 98+229.572 | 4.203                  | 0.050                    | 4.203                                | 0.050                                  |
| S1-E-2    | 98+250.493 | 4.178                  | 0.138                    | 4.200                                | 0.138                                  |
| S1-E-3    | 98+278.451 | 4.286                  | 0.010                    | 4.286                                | 0.010                                  |
| S1-E-4    | 98+306.851 | 4.377                  | 0.210                    | 4.377                                | 0.210                                  |
| S1-E-5    | 98+340.036 | 4.462                  | 0.284                    | 4.462                                | 0.284                                  |
| S1-E-6    | 98+371.873 | 4.505                  | -0.190                   | 4.505                                | -0.190                                 |
| S1-E-7    | 98+411.531 | 4.442                  | 0.302                    | 4.442                                | 0.302                                  |
| S1-E-8    | 98+442.718 | 4.493                  | -0.155                   | 4.493                                | -0.155                                 |
| S1-E-9    | 98+491.630 | 4.381                  | 0.302                    | 4.381                                | 0.302                                  |
| S1-E-10   | 98+530.004 | 4.497                  | -0.214                   | 4.497                                | -0.214                                 |
| S1-E-10   | 98+530.004 | 4.497                  | -0.214                   | 4.497                                | -0.214                                 |
| S1-E-11   | 98+574.987 | 4.699                  | 0.200                    | 4.699                                | 0.200                                  |
| S1-E-11   | 98+574.987 | 4.699                  | 0.200                    | 4.699                                | 0.200                                  |
| S1-E-12   | 98+600.056 | 4.578                  | -0.340                   | 4.578                                | 0.305                                  |
| S1-E-13   | 98+650.023 | 4.678                  | 0.280                    | 4.678                                | 0.280                                  |
| S1-E-14   | 98+679.962 | 4.533                  | -0.315                   | 4.533                                | -0.315                                 |
| S1-E-15   | 98+732.845 | 4.538                  | 0.285                    | 4.538                                | 0.285                                  |
| S1-E-16   | 98+779.971 | 4.830                  | -0.445                   | 4.830                                | 0.300                                  |
| S1-E-17   | 98+836.392 | 5.200                  | 0.250                    | 5.113                                | 0.250                                  |
| S1-E-18   | 98+873.613 | 5.479                  | -0.443                   | 5.479                                | 0.308                                  |
| S1-C-19   | 98+917.717 | 5.442                  | 0.316                    | 5.442                                | 0.316                                  |
| S1-C-20   | 98+955.042 | 5.445                  | -0.262                   | 5.445                                | -0.262                                 |
| S1-C-21   | 98+999.958 | 5.500                  | 0.313                    | 5.500                                | 0.313                                  |
| S1-C-22   | 99+050.005 | 5.445                  | -0.270                   | 5.445                                | -0.270                                 |
| S1-C-23   | 99+097.003 | 5.449                  | 0.238                    | 5.449                                | 0.238                                  |
| S1-C-24   | 99+157.005 | 5.453                  | -0.278                   | 5.453                                | -0.278                                 |
| S1-C-25   | 99+222.977 | 5.143                  | 0.228                    | 5.143                                | 0.228                                  |
| S1-C-26   | 99+260.054 | 4.865                  | 0.225                    | 4.865                                | 0.225                                  |
| S1-C-27   | 99+298.060 | 4.570                  | 0.054                    | 4.510                                | 0.054                                  |
| S1-C-27-1 | 99+319.274 | 4.441                  | -0.028                   | 4.441                                | -0.028                                 |
| S1-C-27-2 | 99+364.274 | 4.369                  | -0.010                   | 4.369                                | -0.010                                 |
| S1-C-28   | 99+419.238 | 4.666                  | -0.305                   | 4.666                                | -0.305                                 |
| S1-E-29   | 99+469.481 | 5.029                  | 0.230                    | 5.029                                | 0.230                                  |

This report has been developed under a privileged and confidential assignment on behalf of the City of Ottawa. While the report has been prepared for release to City Council as requested by the City and counsel to the City, neither the City nor its' counsel waive privilege over the overall assignment.

| Str No    | Stationing  | As-built<br>CW Ht<br>m | As-built<br>Stagger<br>m | After<br>Rectification<br>CW Ht<br>m | After<br>Rectification<br>Stagger<br>m |
|-----------|-------------|------------------------|--------------------------|--------------------------------------|--|
| S1-E-30   | 99+507.920  | 5.229                  | 0.257                    | 5.229                                | 0.257                                  |
| S1-C-31   | 99+548.618  | 5.439                  | 0.275                    | 5.439                                | 0.275                                  |
| S1-C-32   | 99+576.203  | 5.461                  | -0.272                   | 5.461                                | -0.272                                 |
| S1-C-33   | 99+600.015  | 5.534                  | 0.190                    | 5.534                                | 0.190                                  |
| S1-C-33   | 99+600.015  | 5.534                  | 0.190                    | 5.534                                | 0.190                                  |
| S1-C-34   | 99+639.923  | 5.497                  | -0.170                   | 5.497                                | -0.170                                 |
| S1-C-34   | 99+639.923  | 5.497                  | -0.170                   | 5.497                                | -0.170                                 |
| S1-C-35   | 99+679.859  | 5.414                  | 0.118                    | 5.414                                | 0.118                                  |
| S1-E-36   | 99+705.451  | 5.446                  | -0.353                   | 5.446                                | -0.353                                 |
| S1-C-37   | 99+733.924  | 5.449                  | -0.350                   | 5.449                                | -0.350                                 |
| S1-C-38   | 99+764.804  | 5.466                  | -0.337                   | 5.466                                | -0.337                                 |
| S1-C-39   | 99+789.815  | 5.496                  | -0.358                   | 5.496                                | -0.358                                 |
| S1-C-40   | 99+825.102  | 5.472                  | 0.300                    | 5.472                                | 0.300                                  |
| S1-C-41   | 99+859.530  | 5.511                  | -0.285                   | 5.511                                | -0.285                                 |
| S1-C-42   | 99+898.473  | 5.357                  | 0.155                    | 5.357                                | 0.155                                  |
| S1-C-44   | 99+933.568  | 5.365                  | -0.190                   | 5.365                                | -0.190                                 |
| S1-C-45   | 99+989.354  | 5.277                  | -0.130                   | 5.277                                | -0.130                                 |
| S1-C-46   | 100+026.096 | 5.392                  | 0.015                    | 5.392                                | 0.015                                  |
| S1-E-47   | 100+052.001 | 5.221                  | 0.053                    | 5.221                                | 0.053                                  |
| S1-E-48   | 100+080.898 | 5.009                  | 0.362                    | 5.009                                | 0.362                                  |
| S1-E-49   | 100+129.693 | 4.618                  | 0.277                    | 4.618                                | 0.277                                  |
| S1-E-49-1 | 100+170.152 | 4.421                  | -0.043                   | 4.421                                | -0.043                                 |
| S1-E-49-2 | 100+227.369 | 4.167                  | -0.250                   | 4.205                                | -0.250                                 |
| S3-C-1    | 103+440.473 | 5.193                  | 0.261                    | 5.193                                | 0.261                                  |
| S3-C-2    | 103+480.017 | 5.064                  | 0.303                    | 5.064                                | 0.303                                  |
| S3-C-3    | 103+525.276 | 4.736                  | -0.234                   | 4.736                                | -0.234                                 |
| S3-C-3-1  | 103+576.577 | 4.389                  | -0.040                   | 4.389                                | -0.040                                 |
| S3-C-3-2  | 103+624.264 | 4.300                  | 0.030                    | 3.866                                | 0.030                                  |
| S3-E-4    | 103+674.767 | 4.300                  | -0.353                   | 4.235                                | -0.300                                 |
| S3-E-5    | 103+707.231 | 4.430                  | -0.030                   | 4.310                                | -0.030                                 |
| S3-E-5    | 103+707.231 | 4.430                  | -0.030                   | 4.310                                | -0.030                                 |
| S3-C-6    | 103+756.975 | 4.830                  | 0.311                    | 4.830                                | 0.311                                  |
| S3-C-6    | 103+756.975 | 4.830                  | 0.311                    | 4.830                                | 0.311                                  |
| S3-C-7    | 103+786.414 | 5.060                  | 0.303                    | 5.060                                | 0.303                                  |
| S3-C-8    | 103+819.992 | 5.320                  | 0.243                    | 5.359                                | 0.243                                  |
| S3-C-9    | 103+867.164 | 5.500                  | 0.187                    | 5.551                                | 0.187                                  |
| S3-C-10   | 103+916.411 | 5.500                  | 0.262                    | 5.536                                | 0.262                                  |
| S3-C-11   | 103+972.599 | 5.392                  | 0.150                    | 5.392                                | 0.150                                  |
| S3-C-12   | 104+031.954 | 5.366                  | -0.254                   | 5.364                                | -0.254                                 |
| S3-C-13   | 104+081.198 | 5.181                  | 0.182                    | 5.181                                | 0.182                                  |
| S3-C-13   | 104+081.198 | 5.181                  | 0.182                    | 5.181                                | 0.182                                  |

This report has been developed under a privileged and confidential assignment on behalf of the City of Ottawa. While the report has been prepared for release to City Council as requested by the City and counsel to the City, neither the City nor its' counsel waive privilege over the overall assignment.

| Str No    | Stationing  | As-built<br>CW Ht<br>m | As-built<br>Stagger<br>m | After<br>Rectification<br>CW Ht<br>m | After<br>Rectification<br>Stagger<br>m |
|-----------|-------------|------------------------|--------------------------|--------------------------------------|--|
| S3-C-14   | 104+126.073 | 5.432                  | 0.257                    | 5.432                                | 0.257                                  |
| S3-C-14   | 104+126.073 | 5.432                  | 0.257                    | 5.432                                | 0.257                                  |
| S3-C-15   | 104+171.073 | 5.394                  | 0.347                    | 5.394                                | 0.300                                  |
| S3-C-17   | 104+269.000 | 5.483                  | -0.317                   | 5.483                                | -0.317                                 |
| S3-C-19   | 104+354.672 | 4.800                  | -0.220                   | 4.697                                | -0.220                                 |
| S3-C-20   | 104+380.738 | 4.600                  | -0.300                   | 4.547                                | -0.300                                 |
| S3-C-21   | 104+416.409 | 4.507                  | -0.335                   | 4.507                                | -0.335                                 |
| S3-C-22   | 104+473.516 | 4.235                  | 0.287                    | 4.235                                | 0.287                                  |
| S3-C-22-1 | 104+522.456 | 4.224                  | 0.252                    | 4.224                                | 0.252                                  |
| S3-C-23-1 | 104+548.485 | 4.200                  | -0.063                   | 4.198                                | -0.063                                 |
| S3-C-23-2 | 104+594.985 | 4.225                  | 0.210                    | 4.225                                | 0.210                                  |
| S3-C-23-3 | 104+639.985 | 4.200                  | -0.115                   | 4.200                                | -0.115                                 |
| S3-C-24   | 104+671.303 | 4.407                  | -0.320                   | 4.407                                | -0.320                                 |
| S3-C-24-1 | 104+695.864 | 4.334                  | -0.320                   | 4.334                                | -0.320                                 |
| S3-C-25   | 104+716.396 | 4.479                  | -0.208                   | 4.479                                | -0.208                                 |
| S3-C-26   | 104+732.390 | 4.570                  | -0.135                   | 4.570                                | -0.135                                 |
| S3-C-27   | 104+756.839 | 4.715                  | -0.171                   | 4.715                                | -0.171                                 |
| S3-C-28   | 104+781.991 | 4.878                  | 0.290                    | 4.878                                | 0.290                                  |
| S3-C-29   | 104+814.793 | 5.132                  | 0.175                    | 5.132                                | 0.175                                  |
| S3-C-30   | 104+848.436 | 5.386                  | 0.287                    | 5.386                                | 0.287                                  |
| S3-C-31   | 104+882.220 | 5.410                  | -0.245                   | 5.410                                | -0.245                                 |
| S3-C-32   | 104+932.220 | 5.428                  | 0.337                    | 5.428                                | 0.337                                  |
| S3-C-33   | 104+980.060 | 5.494                  | -0.224                   | 5.494                                | -0.224                                 |
| S3-C-34   | 105+030.046 | 5.500                  | 0.327                    | 5.652                                | 0.300                                  |
| S3-C-35   | 105+080.055 | 5.500                  | 0.340                    | 5.622                                | 0.310                                  |
| S3-C-36   | 105+109.189 | 5.500                  | 0.290                    | 5.590                                | 0.290                                  |
| S3-C-37   | 105+133.719 | 5.500                  | 0.253                    | 5.571                                | 0.253                                  |
| S3-C-38   | 105+158.209 | 5.514                  | 0.275                    | 5.514                                | 0.275                                  |
| S3-C-39   | 105+182.791 | 5.402                  | 0.324                    | 5.402                                | 0.324                                  |
| S3-C-40   | 105+205.525 | 5.240                  | 0.348                    | 5.313                                | 0.340                                  |
| S3-C-41   | 105+230.303 | 5.065                  | 0.236                    | 5.065                                | 0.236                                  |
| S3-C-42   | 105+266.499 | 4.775                  | 0.118                    | 4.775                                | 0.118                                  |
| S3-C-43   | 105+293.705 | 4.560                  | 0.040                    | 4.527                                | 0.040                                  |
| S3-C-44   | 105+320.905 | 4.349                  | 0.300                    | 4.349                                | 0.300                                  |
| S3-C-45   | 105+358.250 | 4.200                  | -0.270                   | 4.200                                | -0.270                                 |
| S3-C-45-1 | 105+392.499 | 4.200                  | 0.018                    | 4.204                                | 0.018                                  |
| S3-C-45-2 | 105+422.499 | 4.200                  | -0.014                   | 4.208                                | -0.014                                 |
| S3-C-45-3 | 105+452.499 | 4.200                  | -0.080                   | 4.204                                | -0.080                                 |
| S3-C-46   | 105+497.913 | 4.200                  | -0.279                   | 4.198                                | -0.279                                 |
| S3-C-47   | 105+520.005 | 4.380                  | 0.013                    | 4.302                                | 0.013                                  |
| S3-C-47   | 105+520.005 | 4.380                  | 0.013                    | 4.302                                | 0.013                                  |

This report has been developed under a privileged and confidential assignment on behalf of the City of Ottawa. While the report has been prepared for release to City Council as requested by the City and counsel to the City, neither the City nor its' counsel waive privilege over the overall assignment.

| Str No    | Stationing  | As-built<br>CW Ht<br>m | As-built<br>Stagger<br>m | After<br>Rectification<br>CW Ht<br>m | After<br>Rectification<br>Stagger<br>m |
|-----------|-------------|------------------------|--------------------------|--------------------------------------|--|
| S3-C-49   | 105+563.540 | 4.720                  | -0.211                   | 4.806                                | -0.211                                 |
| S3-C-49   | 105+563.540 | 4.720                  | -0.211                   | 4.806                                | -0.211                                 |
| S3-C-50   | 105+588.766 | 5.074                  | 0.188                    | 5.074                                | 0.188                                  |
| S3-C-51   | 105+614.698 | 5.195                  | 0.309                    | 5.195                                | 0.309                                  |
| S3-C-52   | 105+638.334 | 5.432                  | 0.244                    | 5.432                                | 0.244                                  |
| S3-C-53   | 105+661.970 | 5.569                  | 0.216                    | 5.569                                | 0.216                                  |
| S3-C-54   | 105+685.607 | 5.603                  | 0.245                    | 5.603                                | 0.245                                  |
| S4-C-1    | 105+709.253 | 5.724                  | 0.400                    | 5.599                                | 0.295                                  |
| S4-C-2    | 105+738.042 | 5.702                  | 0.280                    | 5.702                                | 0.280                                  |
| S4-E-3    | 105+759.772 | 5.566                  | -0.125                   | 5.566                                | -0.125                                 |
| S4-C-6    | 105+815.357 | 5.667                  | -0.175                   | 5.667                                | -0.175                                 |
| S4-C-7    | 105+830.233 | 5.677                  | -0.265                   | 5.677                                | -0.265                                 |
| S4-C-8    | 105+863.558 | 5.567                  | -0.270                   | 5.567                                | -0.270                                 |
| S4-C-9    | 105+889.927 | 5.685                  | -0.285                   | 5.685                                | -0.285                                 |
| S4-C-10   | 105+905.211 | 5.637                  | -0.295                   | 5.637                                | -0.295                                 |
| S4-C-11   | 105+927.895 | 5.573                  | -0.302                   | 5.573                                | -0.302                                 |
| S4-C-12   | 105+950.623 | 5.548                  | -0.295                   | 5.548                                | -0.295                                 |
| S4-C-13   | 105+973.351 | 5.586                  | -0.286                   | 5.586                                | -0.286                                 |
| S4-C-14   | 105+996.335 | 5.600                  | -0.280                   | 5.600                                | -0.280                                 |
| S4-C-15   | 106+021.420 | 5.586                  | -0.200                   | 5.586                                | -0.200                                 |
| S4-C-16   | 106+048.865 | 5.600                  | 0.245                    | 5.600                                | 0.245                                  |
| S4-C-18   | 106+084.609 | 5.417                  | -0.180                   | 5.417                                | -0.180                                 |
| S4-C-19   | 106+121.088 | 5.400                  | -0.390                   | 5.400                                | -0.305                                 |
| S4-C-21   | 106+163.320 | 5.584                  | 0.010                    | 5.584                                | 0.010                                  |
| S4-C-22   | 106+211.489 | 5.619                  | 0.295                    | 5.619                                | 0.295                                  |
| S4-C-23   | 106+241.223 | 5.650                  | 0.270                    | 5.650                                | 0.270                                  |
| S4-E-24   | 106+270.840 | 5.460                  | 0.230                    | 5.460                                | 0.230                                  |
| S4-C-25   | 106+300.000 | 5.375                  | -0.200                   | 5.386                                | -0.200                                 |
| S4-C-25   | 106+300.000 | 5.375                  | -0.200                   | 5.386                                | -0.200                                 |
| S4-C-26   | 106+340.043 | 5.290                  | -0.130                   | 5.312                                | -0.130                                 |
| S4-C-26   | 106+340.043 | 5.290                  | -0.130                   | 5.312                                | -0.130                                 |
| S4-C-27   | 106+380.008 | 4.971                  | 0.290                    | 4.971                                | 0.290                                  |
| S4-C-28   | 106+404.736 | 4.829                  | -0.250                   | 4.829                                | -0.250                                 |
| S4-C-28-1 | 106+433.276 | 4.600                  | 0.015                    | 4.585                                | 0.015                                  |
| S4-C-28-2 | 106+478.276 | 4.366                  | 0.025                    | 4.366                                | 0.025                                  |
| S4-C-29   | 106+531.776 | 4.175                  | -0.003                   | 4.175                                | -0.003                                 |
| S4-C-30   | 106+571.095 | 4.355                  | -0.225                   | 4.355                                | -0.225                                 |
| S4-C-31   | 106+610.922 | 4.306                  | 0.280                    | 4.306                                | 0.280                                  |
| S4-C-32   | 106+651.202 | 4.365                  | 0.260                    | 4.365                                | 0.260                                  |
| S4-C-33   | 106+679.816 | 4.357                  | 0.310                    | 4.357                                | 0.310                                  |
| S4-C-34   | 106+705.472 | 4.243                  | 0.150                    | 4.243                                | 0.150                                  |

This report has been developed under a privileged and confidential assignment on behalf of the City of Ottawa. While the report has been prepared for release to City Council as requested by the City and counsel to the City, neither the City nor its' counsel waive privilege over the overall assignment.

| Str No    | Stationing  | As-built<br>CW Ht<br>m | As-built<br>Stagger<br>m | After<br>Rectification<br>CW Ht<br>m | After<br>Rectification<br>Stagger<br>m |
|-----------|-------------|------------------------|--------------------------|--------------------------------------|--|
| S4-E-35   | 106+730.020 | 4.235                  | 0.210                    | 4.235                                | 0.210                                  |
| S4-C-37   | 106+765.096 | 4.235                  | -0.370                   | 4.235                                | -0.270                                 |
| S4-C-38   | 106+810.561 | 4.302                  | -0.240                   | 4.302                                | -0.240                                 |
| S4-C-39   | 106+824.514 | 4.400                  | -0.260                   | 4.423                                | -0.260                                 |
| S4-C-40   | 106+843.360 | 4.560                  | -0.210                   | 4.603                                | -0.210                                 |
| S4-C-41   | 106+863.795 | 4.734                  | 0.045                    | 4.734                                | 0.045                                  |
| S4-C-42   | 106+876.863 | 4.705                  | 0.335                    | 4.705                                | 0.297                                  |
| S4-C-43   | 106+890.699 | 4.693                  | -0.345                   | 4.693                                | -0.260                                 |
| S4-C-44   | 106+914.335 | 4.792                  | 0.022                    | 4.792                                | 0.022                                  |
| S4-C-45   | 106+946.686 | 4.953                  | -0.335                   | 4.953                                | -0.320                                 |
| S4-E-48   | 106+984.415 | 4.753                  | -0.258                   | 4.753                                | -0.258                                 |
| S4-E-50   | 107+024.531 | 4.574                  | 0.130                    | 4.574                                | 0.130                                  |
| S4-E-51-1 | 107+068.039 | 4.200                  | 0.022                    | 4.398                                | 0.022                                  |
| S4-E-52   | 107+100.019 | 4.268                  | -0.020                   | 4.268                                | -0.020                                 |
| S4-E-53   | 107+148.148 | 4.480                  | 0.257                    | 4.480                                | 0.257                                  |
| S4-E-54   | 107+182.848 | 4.762                  | -0.320                   | 4.818                                | -0.320                                 |
| S4-E-56   | 107+242.726 | 5.491                  | -0.240                   | 5.491                                | -0.240                                 |
| S4-E-58   | 107+276.977 | 5.529                  | -0.029                   | 5.529                                | -0.029                                 |
| S4-E-60   | 107+313.229 | 5.540                  | 0.095                    | 5.540                                | 0.095                                  |
| S4-E-62   | 107+345.509 | 5.520                  | -0.065                   | 5.520                                | -0.065                                 |
| S4-E-63   | 107+379.328 | 5.504                  | -0.320                   | 5.504                                | -0.320                                 |
| S4-E-64   | 107+418.397 | 5.421                  | -0.335                   | 5.421                                | -0.320                                 |
| S4-E-64   | 107+418.397 | 5.421                  | -0.335                   | 5.421                                | -0.320                                 |
| S4-E-66   | 107+460.802 | 5.100                  | -0.115                   | 5.301                                | -0.115                                 |
| S4-E-66   | 107+460.802 | 5.100                  | -0.115                   | 5.301                                | -0.115                                 |
| S4-E-67   | 107+493.457 | 4.850                  | -0.226                   | 4.942                                | -0.226                                 |
| S4-E-68   | 107+516.529 | 4.674                  | -0.250                   | 4.674                                | -0.250                                 |
| S4-E-69   | 107+546.521 | 4.436                  | 0.384                    | 4.436                                | 0.384                                  |
| S4-E-70   | 107+570.457 | 4.269                  | 0.240                    | 4.269                                | 0.240                                  |



**Westbound Heights and Stagers**

| Str No    | Stationing  | As-built<br>CW Ht<br>m | As-built<br>Stagger<br>m | After<br>Rectification<br>CW Ht<br>m | After<br>Rectification<br>Stagger<br>m |
|-----------|-------------|------------------------|--------------------------|--------------------------------------|--|
| S1-W-1-5  | 198+147.500 | 4.159                  | 0.032                    | 4.159                                | 0.032                                  |
| S1-W-1-6  | 198+170.000 | 4.159                  | 0.020                    | 4.161                                | 0.020                                  |
| S1-W-1-7  | 198+207.424 | 4.159                  | -0.080                   | 4.163                                | -0.080                                 |
| S1-W-1-10 | 198+228.767 | 4.159                  | -0.030                   | 4.152                                | -0.030                                 |
| S1-W-2-1  | 198+250.493 | 4.167                  | -0.035                   | 4.200                                | -0.035                                 |
| S1-W-3    | 198+278.451 | 4.243                  | -0.205                   | 4.243                                | -0.205                                 |
| S1-W-4    | 198+306.851 | 4.243                  | -0.155                   | 4.243                                | -0.155                                 |
| S1-W-5    | 198+340.036 | 4.468                  | 0.000                    | 4.468                                | 0.000                                  |
| S1-W-6    | 198+371.917 | 4.553                  | 0.145                    | 4.553                                | 0.145                                  |
| S1-W-7    | 198+411.681 | 4.527                  | -0.245                   | 4.527                                | -0.245                                 |
| S1-W-8    | 198+442.946 | 4.508                  | 0.205                    | 4.508                                | 0.205                                  |
| S1-W-9    | 198+491.830 | 4.450                  | -0.305                   | 4.367                                | -0.305                                 |
| S1-W-10   | 198+529.999 | 4.786                  | 0.070                    | 4.786                                | 0.070                                  |
| S1-W-10   | 198+529.999 | 4.786                  | 0.070                    | 4.786                                | 0.070                                  |
| S1-W-11   | 198+575.151 | 4.682                  | -0.255                   | 4.682                                | -0.255                                 |
| S1-W-11   | 198+575.151 | 4.682                  | -0.255                   | 4.682                                | -0.255                                 |
| S1-W-12   | 198+600.064 | 4.489                  | 0.268                    | 4.489                                | 0.268                                  |
| S1-W-13   | 198+650.030 | 4.658                  | -0.330                   | 4.658                                | -0.305                                 |
| S1-W-14   | 198+679.968 | 4.439                  | 0.275                    | 4.439                                | 0.275                                  |
| S1-W-15   | 198+732.851 | 4.587                  | -0.313                   | 4.587                                | -0.313                                 |
| S1-W-16   | 198+779.978 | 4.909                  | 0.217                    | 4.909                                | 0.217                                  |
| S1-W-17   | 198+836.398 | 5.274                  | -0.373                   | 5.273                                | -0.310                                 |
| S1-W-18   | 198+873.619 | 5.428                  | 0.125                    | 5.428                                | 0.125                                  |
| S1-C-19   | 198+917.723 | 5.464                  | -0.367                   | 5.464                                | -0.300                                 |
| S1-C-20   | 198+955.048 | 5.496                  | 0.210                    | 5.496                                | 0.210                                  |
| S1-C-21   | 198+999.965 | 5.523                  | -0.337                   | 5.523                                | -0.300                                 |
| S1-C-22   | 199+050.011 | 5.400                  | 0.227                    | 5.400                                | 0.227                                  |
| S1-C-23   | 199+097.011 | 5.433                  | -0.293                   | 5.433                                | -0.293                                 |
| S1-C-24   | 199+157.011 | 5.428                  | 0.208                    | 5.428                                | 0.208                                  |
| S1-C-25   | 199+222.989 | 5.123                  | -0.272                   | 5.123                                | -0.272                                 |
| S1-C-26   | 199+259.673 | 4.800                  | -0.240                   | 4.769                                | -0.240                                 |
| S1-C-27   | 199+297.368 | 4.540                  | -0.288                   | 4.540                                | -0.288                                 |
| S1-C-27-1 | 199+318.582 | 4.458                  | 0.020                    | 4.458                                | 0.020                                  |
| S1-C-27-2 | 199+363.582 | 4.455                  | 0.050                    | 4.455                                | 0.050                                  |
| S1-C-28   | 199+418.546 | 4.700                  | -0.245                   | 4.628                                | -0.245                                 |
| S1-W-29   | 199+468.551 | 5.054                  | -0.248                   | 5.054                                | -0.248                                 |
| S1-W-30   | 199+506.586 | 5.326                  | -0.297                   | 5.326                                | -0.297                                 |
| S1-C-31   | 199+547.147 | 5.446                  | -0.335                   | 5.446                                | -0.300                                 |
| S1-C-32   | 199+574.726 | 5.515                  | 0.275                    | 5.515                                | 0.275                                  |
| S1-C-33   | 199+598.539 | 5.503                  | -0.223                   | 5.503                                | -0.223                                 |

This report has been developed under a privileged and confidential assignment on behalf of the City of Ottawa. While the report has been prepared for release to City Council as requested by the City and counsel to the City, neither the City nor its' counsel waive privilege over the overall assignment.

| Str No    | Stationing  | As-built<br>CW Ht<br>m | As-built<br>Stagger<br>m | After<br>Rectification<br>CW Ht<br>m | After<br>Rectification<br>Stagger<br>m |
|-----------|-------------|------------------------|--------------------------|--------------------------------------|--|
| S1-C-34   | 199+638.447 | 5.497                  | 0.208                    | 5.497                                | 0.208                                  |
| S1-C-34   | 199+638.447 | 5.497                  | 0.208                    | 5.497                                | 0.208                                  |
| S1-C-35   | 199+678.412 | 5.462                  | -0.300                   | 5.462                                | -0.300                                 |
| S1-C-35   | 199+678.412 | 5.462                  | -0.300                   | 5.462                                | -0.300                                 |
| S1-W-36   | 199+704.018 | 5.497                  | 0.185                    | 5.497                                | 0.185                                  |
| S1-C-37   | 199+733.257 | 5.614                  | 0.135                    | 5.614                                | 0.135                                  |
| S1-C-38   | 199+764.768 | 5.662                  | 0.287                    | 5.662                                | 0.287                                  |
| S1-C-39   | 199+790.136 | 5.557                  | 0.354                    | 5.557                                | 0.304                                  |
| S1-C-40   | 199+825.548 | 5.498                  | -0.288                   | 5.498                                | -0.288                                 |
| S1-C-41   | 199+859.975 | 5.316                  | 0.285                    | 5.316                                | 0.285                                  |
| S1-C-42   | 199+898.918 | 5.279                  | 0.132                    | 5.279                                | 0.132                                  |
| S1-C-44   | 199+934.013 | 5.259                  | -0.075                   | 5.259                                | -0.075                                 |
| S1-C-45   | 199+989.799 | 5.282                  | -0.150                   | 5.282                                | -0.150                                 |
| S1-C-46   | 200+026.541 | 5.365                  | 0.050                    | 5.365                                | 0.050                                  |
| S1-W-47   | 200+052.854 | 5.209                  | -0.020                   | 5.209                                | -0.020                                 |
| S1-W-48   | 200+081.331 | 5.000                  | 0.070                    | 4.978                                | 0.070                                  |
| S1-W-49   | 200+130.128 | 4.660                  | 0.250                    | 4.447                                | 0.250                                  |
| S1-W-49-1 | 200+171.524 | 4.357                  | 0.090                    | 4.357                                | 0.090                                  |
| S1-W-49-2 | 200+226.532 | 4.285                  | 0.335                    | 4.285                                | 0.335                                  |
| S3-C-1    | 203+443.562 | 5.166                  | 0.462                    | 5.166                                | 0.295                                  |
| S3-C-2    | 203+482.701 | 5.091                  | -0.263                   | 5.091                                | -0.263                                 |
| S3-C-3    | 203+528.136 | 4.750                  | 0.290                    | 4.706                                | 0.290                                  |
| S3-C-3-1  | 203+579.503 | 4.497                  | 0.200                    | 4.497                                | 0.200                                  |
| S3-C-3-2  | 203+627.190 | 4.300                  | 0.046                    | 4.200                                | 0.046                                  |
| S3-W-4    | 203+677.968 | 4.300                  | -0.282                   | 4.230                                | -0.282                                 |
| S3-W-5    | 203+710.001 | 4.409                  | 0.109                    | 4.363                                | 0.109                                  |
| S3-W-5    | 203+710.001 | 4.409                  | 0.109                    | 4.363                                | 0.109                                  |
| S3-C-6    | 203+759.843 | 4.807                  | -0.244                   | 4.807                                | -0.244                                 |
| S3-C-6    | 203+759.843 | 4.807                  | -0.244                   | 4.807                                | -0.244                                 |
| S3-C-7    | 203+789.101 | 5.026                  | -0.275                   | 5.026                                | -0.275                                 |
| S3-C-8    | 203+822.392 | 5.270                  | -0.170                   | 5.270                                | -0.170                                 |
| S3-C-9    | 203+869.154 | 5.450                  | -0.154                   | 5.450                                | -0.154                                 |
| S3-C-10   | 203+918.022 | 5.462                  | -0.235                   | 5.462                                | -0.235                                 |
| S3-C-11   | 203+974.116 | 5.377                  | 0.055                    | 5.377                                | 0.055                                  |
| S3-C-12   | 204+033.534 | 5.500                  | 0.253                    | 5.535                                | 0.253                                  |
| S3-C-13   | 204+083.021 | 5.253                  | 0.323                    | 5.253                                | 0.323                                  |
| S3-C-14   | 204+128.021 | 5.397                  | -0.150                   | 5.397                                | -0.150                                 |
| S3-C-14   | 204+128.021 | 5.397                  | -0.150                   | 5.397                                | -0.150                                 |
| S3-C-15   | 204+173.021 | 5.457                  | 0.240                    | 5.457                                | 0.240                                  |
| S3-C-15   | 204+173.021 | 5.457                  | 0.240                    | 5.457                                | 0.240                                  |
| S3-C-16   | 204+218.221 | 5.441                  | 0.500                    | 5.441                                | 0.390                                  |

This report has been developed under a privileged and confidential assignment on behalf of the City of Ottawa. While the report has been prepared for release to City Council as requested by the City and counsel to the City, neither the City nor its' counsel waive privilege over the overall assignment.

| Str No    | Stationing  | As-built<br>CW Ht<br>m | As-built<br>Stagger<br>m | After<br>Rectification<br>CW Ht<br>m | After<br>Rectification<br>Stagger<br>m |
|-----------|-------------|------------------------|--------------------------|--------------------------------------|--|
| S3-C-17   | 204+270.948 | 5.116                  | -0.226                   | 5.116                                | -0.226                                 |
| S3-C-18   | 204+323.701 | 4.953                  | 0.302                    | 4.953                                | 0.302                                  |
| S3-C-19   | 204+356.821 | 4.745                  | 0.270                    | 4.745                                | 0.270                                  |
| S3-C-20   | 204+383.015 | 4.571                  | 0.293                    | 4.571                                | 0.293                                  |
| S3-C-21   | 204+418.821 | 4.481                  | 0.304                    | 4.481                                | 0.304                                  |
| S3-C-22   | 204+475.921 | 4.324                  | -0.250                   | 4.324                                | -0.250                                 |
| S3-C-22-1 | 204+524.819 | 4.257                  | 0.360                    | 4.257                                | 0.360                                  |
| S3-C-23-1 | 204+550.848 | 4.200                  | -0.100                   | 4.148                                | -0.100                                 |
| S3-C-23-2 | 204+597.348 | 4.195                  | 0.410                    | 4.195                                | 0.350                                  |
| S3-C-23-3 | 204+642.348 | 4.200                  | 0.137                    | 4.151                                | 0.137                                  |
| S3-C-24   | 204+673.711 | 4.282                  | 0.300                    | 4.282                                | 0.300                                  |
| S3-C-24-1 | 204+698.877 | 4.283                  | 0.484                    | 4.283                                | 0.300                                  |
| S3-C-25   | 204+720.124 | 4.444                  | 0.240                    | 4.444                                | 0.240                                  |
| S3-C-26   | 204+736.674 | 4.551                  | 0.262                    | 4.551                                | 0.262                                  |
| S3-C-27   | 204+761.860 | 4.748                  | 0.240                    | 4.748                                | 0.240                                  |
| S3-C-28   | 204+787.132 | 4.920                  | -0.263                   | 4.833                                | -0.263                                 |
| S3-C-29   | 204+819.935 | 5.168                  | -0.008                   | 5.168                                | -0.008                                 |
| S3-C-30   | 204+853.578 | 5.401                  | -0.245                   | 5.401                                | -0.245                                 |
| S3-C-31   | 204+887.362 | 5.321                  | 0.278                    | 5.321                                | 0.278                                  |
| S3-C-32   | 204+937.362 | 5.359                  | -0.309                   | 5.359                                | -0.309                                 |
| S3-C-33   | 204+985.202 | 5.437                  | 0.300                    | 5.437                                | 0.300                                  |
| S3-C-34   | 205+035.187 | 5.622                  | -0.177                   | 5.622                                | -0.177                                 |
| S3-C-35   | 205+085.063 | 5.550                  | -0.249                   | 5.550                                | -0.249                                 |
| S3-C-36   | 205+113.531 | 5.544                  | -0.305                   | 5.544                                | -0.305                                 |
| S3-C-37   | 205+137.264 | 5.563                  | -0.287                   | 5.563                                | -0.287                                 |
| S3-C-38   | 205+160.964 | 5.513                  | -0.291                   | 5.513                                | -0.291                                 |
| S3-C-39   | 205+184.753 | 5.383                  | -0.318                   | 5.383                                | -0.318                                 |
| S3-C-40   | 205+206.753 | 5.240                  | -0.279                   | 5.198                                | -0.279                                 |
| S3-C-41   | 205+230.757 | 5.040                  | -0.303                   | 4.696                                | -0.303                                 |
| S3-C-42   | 205+266.443 | 4.760                  | -0.294                   | 4.736                                | -0.294                                 |
| S3-C-43   | 205+293.643 | 4.556                  | 0.095                    | 4.556                                | 0.095                                  |
| S3-C-44   | 205+320.843 | 4.390                  | 0.307                    | 4.390                                | 0.307                                  |
| S3-C-45   | 205+358.250 | 4.190                  | -0.264                   | 4.190                                | -0.264                                 |
| S3-C-45-1 | 205+392.499 | 4.200                  | -0.010                   | 4.209                                | -0.010                                 |
| S3-C-45-2 | 205+422.499 | 4.200                  | 0.015                    | 4.216                                | 0.015                                  |
| S3-C-45-3 | 205+452.499 | 4.200                  | 0.031                    | 4.210                                | 0.031                                  |
| S3-C-46   | 205+497.913 | 4.200                  | 0.295                    | 4.210                                | 0.295                                  |
| S3-C-47   | 205+520.005 | 4.380                  | -0.187                   | 4.263                                | -0.187                                 |
| S3-C-48   | 205+542.141 | 4.640                  | -0.092                   | 4.529                                | -0.092                                 |
| S3-C-48   | 205+542.141 | 4.640                  | -0.092                   | 4.529                                | -0.092                                 |
| S3-C-49   | 205+563.540 | 4.810                  | -0.185                   | 4.794                                | -0.185                                 |

This report has been developed under a privileged and confidential assignment on behalf of the City of Ottawa. While the report has been prepared for release to City Council as requested by the City and counsel to the City, neither the City nor its' counsel waive privilege over the overall assignment.

| Str No    | Stationing  | As-built<br>CW Ht<br>m | As-built<br>Stagger<br>m | After<br>Rectification<br>CW Ht<br>m | After<br>Rectification<br>Stagger<br>m |
|-----------|-------------|------------------------|--------------------------|--------------------------------------|--|
| S3-C-49   | 205+563.540 | 4.810                  | -0.185                   | 4.794                                | -0.185                                 |
| S3-C-50   | 205+588.563 | 4.971                  | -0.255                   | 4.971                                | -0.255                                 |
| S3-C-50   | 205+588.563 | 4.971                  | -0.255                   | 4.971                                | -0.255                                 |
| S3-C-51   | 205+613.758 | 5.190                  | -0.265                   | 5.190                                | -0.265                                 |
| S3-C-52   | 205+636.565 | 5.336                  | -0.269                   | 5.336                                | -0.269                                 |
| S3-C-53   | 205+659.372 | 5.497                  | -0.234                   | 5.497                                | -0.234                                 |
| S3-C-54   | 205+682.179 | 5.490                  | -0.245                   | 5.490                                | -0.245                                 |
| S4-C-1    | 205+704.991 | 5.604                  | -0.175                   | 5.604                                | -0.175                                 |
| S4-C-2    | 205+733.236 | 5.643                  | -0.270                   | 5.643                                | -0.270                                 |
| S4-W-4    | 205+787.295 | 5.543                  | -0.170                   | 5.543                                | -0.170                                 |
| S4-C-6    | 205+810.529 | 5.621                  | 0.070                    | 5.621                                | 0.070                                  |
| S4-C-7    | 205+825.405 | 5.628                  | 0.410                    | 5.628                                | 0.270                                  |
| S4-C-8    | 205+858.753 | 5.604                  | 0.295                    | 5.604                                | 0.295                                  |
| S4-C-9    | 205+885.625 | 5.661                  | 0.280                    | 5.661                                | 0.280                                  |
| S4-C-10   | 205+901.441 | 5.656                  | 0.240                    | 5.686                                | 0.240                                  |
| S4-C-11   | 205+924.950 | 5.687                  | 0.250                    | 5.687                                | 0.250                                  |
| S4-C-12   | 205+948.505 | 5.689                  | 0.230                    | 5.689                                | 0.230                                  |
| S4-C-13   | 205+972.059 | 5.768                  | 0.415                    | 5.618                                | 0.295                                  |
| S4-C-14   | 205+995.852 | 5.696                  | 0.250                    | 5.696                                | 0.250                                  |
| S4-C-15   | 206+021.364 | 5.584                  | 0.190                    | 5.584                                | 0.190                                  |
| S4-C-16   | 206+048.832 | 5.542                  | 0.250                    | 5.542                                | 0.250                                  |
| S4-C-18   | 206+084.576 | 5.465                  | -0.155                   | 5.465                                | -0.155                                 |
| S4-C-19   | 206+121.055 | 5.356                  | -0.065                   | 5.356                                | -0.065                                 |
| S4-C-21   | 206+163.287 | 5.549                  | -0.015                   | 5.549                                | -0.015                                 |
| S4-C-22   | 206+211.232 | 5.568                  | -0.245                   | 5.568                                | -0.245                                 |
| S4-C-23   | 206+240.356 | 5.549                  | -0.250                   | 5.549                                | -0.250                                 |
| S4-W-24   | 206+269.411 | 5.499                  | -0.300                   | 5.123                                | -0.300                                 |
| S4-C-25   | 206+297.958 | 5.530                  | -0.230                   | 5.537                                | -0.230                                 |
| S4-C-26   | 206+337.890 | 5.335                  | -0.305                   | 5.335                                | -0.305                                 |
| S4-C-26   | 206+337.890 | 5.335                  | -0.305                   | 5.335                                | -0.305                                 |
| S4-C-27   | 206+377.855 | 5.047                  | 0.215                    | 5.047                                | 0.215                                  |
| S4-C-27   | 206+377.855 | 5.047                  | 0.215                    | 5.047                                | 0.215                                  |
| S4-C-28   | 206+402.584 | 4.854                  | -0.290                   | 4.854                                | -0.290                                 |
| S4-C-28-1 | 206+431.124 | 4.625                  | -0.005                   | 4.509                                | -0.005                                 |
| S4-C-28-2 | 206+476.124 | 4.397                  | 0.050                    | 4.397                                | 0.050                                  |
| S4-C-29   | 206+529.624 | 4.300                  | 0.030                    | 4.360                                | 0.030                                  |
| S4-C-30   | 206+569.279 | 4.351                  | 0.330                    | 4.351                                | 0.330                                  |
| S4-C-31   | 206+609.270 | 4.289                  | -0.197                   | 4.289                                | -0.197                                 |
| S4-C-32   | 206+649.252 | 4.387                  | -0.218                   | 4.387                                | -0.218                                 |
| S4-C-33   | 206+677.331 | 4.317                  | -0.205                   | 4.317                                | -0.205                                 |
| S4-C-34   | 206+702.621 | 4.266                  | -0.085                   | 4.266                                | -0.085                                 |

This report has been developed under a privileged and confidential assignment on behalf of the City of Ottawa. While the report has been prepared for release to City Council as requested by the City and counsel to the City, neither the City nor its' counsel waive privilege over the overall assignment.

| Str No    | Stationing  | As-built<br>CW Ht<br>m | As-built<br>Stagger<br>m | After<br>Rectification<br>CW Ht<br>m | After<br>Rectification<br>Stagger<br>m |
|-----------|-------------|------------------------|--------------------------|--------------------------------------|--|
| S4-W-35   | 206+728.231 | 4.289                  | -0.290                   | 4.289                                | -0.290                                 |
| S4-C-36   | 206+759.708 | 4.200                  | 0.300                    | 4.200                                | 0.300                                  |
| S4-C-37   | 206+762.225 | 4.200                  | 0.300                    | 4.200                                | 0.300                                  |
| S4-C-38   | 206+808.105 | 4.220                  | 0.300                    | 4.400                                | 0.300                                  |
| S4-C-39   | 206+822.530 | 4.300                  | 0.300                    | 4.450                                | 0.300                                  |
| S4-C-40   | 206+842.062 | 4.596                  | 0.270                    | 4.596                                | 0.270                                  |
| S4-C-41   | 206+863.224 | 4.946                  | -0.032                   | 4.946                                | -0.032                                 |
| S4-C-42   | 206+876.629 | 4.969                  | 0.310                    | 4.969                                | 0.310                                  |
| S4-C-44   | 206+914.331 | 4.882                  | -0.270                   | 4.882                                | -0.270                                 |
| S4-C-45   | 206+946.682 | 4.883                  | -0.125                   | 4.883                                | -0.125                                 |
| S4-C-49   | 206+988.842 | 4.790                  | -0.245                   | 4.883                                | -0.245                                 |
| S4-W-51   | 207+031.702 | 4.453                  | -0.045                   | 4.453                                | -0.045                                 |
| S4-W-51-1 | 207+068.035 | 4.410                  | -0.205                   | 4.426                                | -0.205                                 |
| S4-W-52   | 207+099.942 | 4.536                  | -0.365                   | 4.536                                | -0.299                                 |
| S4-W-53   | 207+147.999 | 4.920                  | -0.373                   | 4.913                                | -0.373                                 |
| S4-W-55   | 207+198.119 | 5.319                  | 0.275                    | 5.319                                | 0.275                                  |
| S4-W-57   | 207+251.596 | 5.541                  | 0.120                    | 5.541                                | 0.120                                  |
| S4-W-57   | 207+251.596 | 5.541                  | 0.120                    | 5.541                                | 0.120                                  |
| S4-W-59   | 207+306.117 | 5.521                  | -0.172                   | 5.521                                | -0.172                                 |
| S4-W-59   | 207+306.117 | 5.521                  | -0.172                   | 5.521                                | -0.172                                 |
| S4-W-61   | 207+341.592 | 5.721                  | -0.025                   | 5.721                                | -0.025                                 |
| S4-W-63   | 207+379.212 | 5.635                  | -0.032                   | 5.635                                | -0.032                                 |
| S4-W-65   | 207+427.878 | 5.250                  | -0.288                   | 5.294                                | -0.288                                 |
| S4-W-66   | 207+460.968 | 5.000                  | -0.285                   | 5.000                                | -0.285                                 |
| S4-W-67   | 207+491.912 | 4.766                  | -0.090                   | 4.766                                | -0.090                                 |
| S4-W-68   | 207+516.503 | 4.594                  | -0.325                   | 4.594                                | -0.325                                 |
| S4-W-69   | 207+546.087 | 4.487                  | -0.280                   | 4.487                                | -0.280                                 |
| S4-W-70   | 207+569.469 | 4.440                  | -0.270                   | 4.440                                | -0.270                                 |

## D. Videos – OCS Observations

**Table D.1: Videos from Wheel Rail Videos 2018.zip file – Route details**

| Video File: | From       | To         | Route & Pantograph View  |
|-------------|------------|------------|--|
| Gx060037-1  | EOL        | S4-C-28-2  | Westbound - Blair Station to Tremblay Station - First pantograph looking backward.             |
| Gx060037-2  | S4-C-28-2  | S2-T-W-220 | Westbound - Tremblay Station to Rideau Station - First pantograph looking backward.            |
| Gx060037-3  | S2-T-W-??? | EOL        | Westbound - Rideau Station to Tunneys Pasture Station - First pantograph looking backward.     |
| Gx060037-4  | EOL        | S2-T-E-135 | Eastbound - Tunneys Pasture Station to Parliament Station - Second pantograph looking forward. |
| Gx060037-5  | S2-T-E-135 | S3-C-51    | Eastbound - Parliament Station to Hurdman Station- Second pantograph looking forward.          |
| Gx060037-6  | S3-C-51    | EOL        | Eastbound - Hurdman Station to Blair Station - Second pantograph looking forward.              |
| Gx060037-7  | EOL        |            | No additional footage to review.   |

**Table D.2: Videos from Wheel Rail Videos 2018.zip file – OCS observations**

| Video File: | ~Time    | ~Location     | Observation   |
|-------------|----------|---------------|---|
| Gx060037-1  | EOL      | Blair Station |   |
| Gx060037-1  | 00:01:49 | S5-E-60       | Jumper in the span S5-E-58 to S5-E-60 seems too long or loose |
| Gx060037-1  | 00:01:51 | S5-E-60       | Pantograph passage over SI noisy                              |
| Gx060037-1  | 00:02:02 | S5-C-54       | Pantograph horn scraping on main line CW                      |
| Gx060037-1  | 00:02:04 | S5-C-54       | Pantograph passage over SI noisy                              |
| Gx060037-1  | 00:02:05 | S5-C-54       | Pantograph horn scraping on main line CW                      |
| Gx060037-1  | 00:02:08 | S5-W-53       | Pantograph horn scraping on crossover CW                      |
| Gx060037-1  | 00:04:36 | S5-W-18       | Clicking sound at first dropper                               |
| Gx060037-1  | 00:04:38 | S5-W-17       | Clicking sound at registration point and first dropper        |
| Gx060037-1  | 00:04:39 | S5-W-16       | Clicking sound at first dropper                               |
| Gx060037-1  | 00:04:46 | S5-W-13       | Clicking sound mid-span                                       |
| Gx060037-1  | 00:05:04 | S5-W-7        | Clicking sound at registration point                          |
| Gx060037-1  | 00:05:06 | S5-W-6        | Clicking sound at registration point                          |
| Gx060037-1  | 00:05:06 | S5-W-2        | Clicking sound at registration point                          |

This report has been developed under a privileged and confidential assignment on behalf of the City of Ottawa. While the report has been prepared for release to City Council as requested by the City and counsel to the City, neither the City nor its' counsel waive privilege over the overall assignment.



| Video File: | ~Time    | ~Location | Observation  |
|-------------|----------|-----------|--|
| Gx060037-1  | 00:05:20 |           | Arcing along OCR at overlap after transition (overlap not shown on as-built drawing) |
| Gx060037-1  | 00:06:21 |           | Clicking sound at OCR overlap leaving platform (not on as-built drawing)             |
| Gx060037-1  | 00:06:57 | S4-W-68   | Clicking sound at in-span jumper   |
| Gx060037-1  | 00:07:02 | S4-W-66   | Clicking sound at registration   |
| Gx060037-1  | 00:07:07 | S4-W-65   | Pantograph horn scraping on crossover CW   |
| Gx060037-1  | 00:07:42 | S4-C-49   | Clicking sound 3rd dropper   |
| Gx060037-1  | 00:07:49 | S4-C-44   | Clicking sound at registration   |
| Gx060037-1  | 00:07:50 | S4-C-44   | Clicking sound 2nd dropper   |
| Gx060037-1  | 00:07:55 | S4-C-41   | Clicking sound at mid-point anchor/in-span jumper                                    |
| Gx060037-1  | 00:07:56 | S4-C-41   | Pantograph passage over SI noisy, stagger >100mm                                     |
| Gx060037-1  | 00:08:28 | S4-C-29   | Clicking sound in-span before bridge   |
| Gx060037-2  | 00:01:32 | S4-C-1    | Clicking sound at 1st dropper  |
| Gx060037-2  | 00:01:58 | S3-C-46   | Clicking sound at 6th dropper  |
| Gx060037-2  | 00:03:00 | S3-C-41   | Clicking sound at registration   |
| Gx060037-2  | 00:03:11 | S3-C-36   | Clicking sound at registration   |
| Gx060037-2  | 00:05:34 | S3-W-4    | Clicking sound at 1st dropper/jumper wire  |
| Gx060037-2  | 00:06:29 | S3-C-3-1  | Cut-in insulation in MW  |
| Gx060037-2  | 00:06:39 | S2-W-11   | Clicking sound at registration   |
| Gx060037-2  | 00:06:42 | S2-W-11   | Pantograph horn scraping on 2nd crossover CW   |
| Gx060037-2  | 00:06:43 | S2-W-10   | Pantograph horn scraping on crossover CW   |
| Gx060037-2  | 00:06:48 | S2-W-8    | Clicking sound at in-span jumper/dropper   |
| Gx060037-2  | 00:06:52 |           | Arcing along OCR at overlap after transition (overlap not shown on as-built drawing) |
| Gx060037-2  | 00:07:12 |           | Arcing along OCR at overlap (overlap not shown on as-built drawing)                  |
| Gx060037-2  | 00:07:14 |           | Arcing Between OCR and Pantograph 2 events   |

| Video File: | ~Time    | ~Location | Observation  |
|-------------|----------|-----------|--|
| Gx060037-2  | 00:07:52 |           | Arcing Between OCR and Pantograph 1 events                                   |
| Gx060037-3  | 00:00:17 |           | Arcing Between OCR and Pantograph 5 events                                   |
| Gx060037-3  | 00:00:22 |           | Arcing along OCR at overlap (overlap not shown on as-built drawing)          |
| Gx060037-3  | 00:00:17 |           | Arcing Between OCR and Pantograph +10 events                                 |
| Gx060037-3  | 00:01:30 |           | Arcing Between OCR and Pantograph 3 events                                   |
| Gx060037-3  | 00:01:45 |           | Arcing Between OCR and Pantograph 7 events                                   |
| Gx060037-3  | 00:01:50 |           | Arcing Between OCR and Pantograph 4 events                                   |
| Gx060037-3  | 00:01:50 |           | Arcing Between OCR and Pantograph 2 events                                   |
| Gx060037-3  | 00:02:05 |           | Arcing Between OCR and Pantograph 1 events                                   |
| Gx060037-3  | 00:03:09 |           | Arcing Between OCR and Pantograph 3 events                                   |
| Gx060037-3  | 00:03:19 |           | Arcing Between OCR and Pantograph 1 events                                   |
| Gx060037-3  | 00:03:48 |           | Arcing Between OCR and Pantograph 8 events (right before portal)             |
| Gx060037-3  | 00:04:05 | S2-W-1    | Clicking sound at registration   |
| Gx060037-3  | 00:05:05 | S1-C-46   | As-built drawings incorrect - no double crossover installed - provision only |
| Gx060037-3  | 00:05:14 | S1-C-42   | Clicking sound at registration   |
| Gx060037-3  | 00:05:14 | S1-C-44   | Clicking sound at registration   |
| Gx060037-3  | 00:05:24 | S1-C-38   | Clicking sound at registration   |
| Gx060037-3  | 00:05:24 | S1-C-35   | Insulated overlap bonded   |
| Gx060037-3  | 00:05:47 | S1-W-29   | Cable over head does not look secure   |
| Gx060037-3  | 00:05:48 | S1-W-29   | At mid-span, splice in MW  |
| Gx060037-3  | 00:06:43 | S1-C-23   | Clicking sound at registration   |
| Gx060037-3  | 00:07:33 | S1-W-4    | Clicking sound at registration   |
| Gx060037-3  | 00:07:33 | S1-W-3    | Pantograph horn scraping on crossover CW                                     |
| Gx060037-3  | 00:07:37 | S1-W-2-1  | Pantograph passage over SI noisy   |

| Video File: | ~Time    | ~Location          | Observation  |
|-------------|----------|--------------------|--|
| Gx060037-3  | 00:07:42 | S1-W-2-1           | Pantograph horn scraping on crossover CW   |
| Gx060037-4  | 00:02:39 | S1-W-1-10          | Pantograph passage over SI noisy and arcing W-E crossover                            |
| Gx060037-4  | 00:02:39 | S1-W-1-10          | SIs in main line and E-W crossover - not as per shown on as-built drawings           |
| Gx060037-4  | 00:02:39 | S1-W-1-10          | Pantograph horn scraping on E-W crossover CW   |
| Gx060037-4  | 00:02:42 | S1-E-2             | Pantograph horn scraping on main line CW   |
| Gx060037-4  | 00:02:56 | S1-E-7             | Clicking sound at 1st dropper  |
| Gx060037-4  | 00:03:18 | S1-E-17            | Clicking sound at 1st dropper  |
| Gx060037-4  | 00:03:40 | S1-C-25            | Clicking sound at registration   |
| Gx060037-4  | 00:04:33 | S1-C-27-1          | Clicking sound at last dropper   |
| Gx060037-4  | 00:04:40 | S1-C-28            | At mid-span, splice in MW  |
| Gx060037-4  | 00:04:41 | S1-C-28            | Cable over head does not look secure   |
| Gx060037-4  | 00:04:42 | S1-E-29            | Clicking sound at registration   |
| Gx060037-4  | 00:04:45 | S1-E-30            | Clicking sound at first dropper  |
| Gx060037-4  | 00:04:51 | S1-C-33            | Clicking sounds through overlap  |
| Gx060037-4  | 00:04:53 | S1-C-33            | Insulated overlap bonded   |
| Gx060037-4  | 00:04:54 | S1-C-34            | Arcing   |
| Gx060037-4  | 00:04:58 | S1-E-36            | Clicking sounds in first part of span  |
| Gx060037-4  | 00:05:00 | S1-C-37            | Clicking sounds in first part of span  |
| Gx060037-4  | 00:05:03 | S1-C-38            | Clicking sounds in first part of span  |
| Gx060037-4  | 00:05:05 | S1-C-39            | Clicking sounds in first part of span  |
| Gx060037-4  | 00:05:13 | S1-C-42            | Clicking sound at first dropper  |
| Gx060037-4  | 00:06:22 | S2-E-1             | Stagger >500mm   |
| Gx060037-4  | 00:06:34 | West Tunnel Portal |  |
| Gx060037-4  | 00:06:35 |                    | Arcing along OCR at overlap after transition (overlap not shown on as-built drawing) |

| Video File: | ~Time    | ~Location          | Observation   |
|-------------|----------|--------------------|---|
| Gx060037-3  | 00:06:38 |                    | Arcing Between OCR and Pantograph 1 events few spans before jet fan 1-2                       |
| Gx060037-3  | 00:07:17 |                    | Arcing along OCR at overlap   |
| Gx060037-3  | 00:07:21 |                    | Arcing Between OCR and Pantograph 2 events  |
| Gx060037-3  | 00:07:40 | Lyon Station       |   |
| Gx060037-3  | 00:08:18 |                    | Arcing Between OCR and Pantograph 2 events  |
| Gx060037-3  | 00:08:21 |                    | Arcing Between OCR and Pantograph 2 events  |
| Gx060037-3  | 00:08:25 |                    | Arcing Between OCR and Pantograph 7 events  |
| Gx060037-3  | 00:08:36 |                    | Arcing Between OCR and Pantograph 1 events  |
| Gx060037-3  | 00:08:52 | Parliament Station |   |
| Gx060037-3  | 00:00:50 |                    | Arcing Between OCR and Pantograph 3 events  |
| Gx060037-3  | 00:00:53 |                    | Arcing Between OCR and Pantograph 1 event   |
| Gx060037-5  | 00:00:56 |                    | Arcing along OCR at overlap (overlap not shown on as-built drawing)                           |
| Gx060037-3  | 00:01:01 |                    | Arcing Between OCR and Pantograph 1 event   |
| Gx060037-5  | 00:01:09 |                    | Arcing along OCR at overlap (overlap not shown on as-built drawing)                           |
| Gx060037-3  | 00:01:18 |                    | Arcing Between OCR and Pantograph 1 event   |
| Gx060037-5  | 00:01:37 |                    | Arcing along OCR at overlap (overlap not shown on as-built drawing)                           |
| Gx060037-5  | 00:01:37 | Rideau Station     |   |
| Gx060037-5  | 00:02:52 |                    | Arcing along OCR at overlap (overlap not shown on as-built drawing)                           |
| Gx060037-5  | 00:03:11 |                    | Arcing along OCR at overlap (overlap not shown on as-built drawing)                           |
| Gx060037-3  | 00:03:13 |                    | Arcing Between OCR and Pantograph 3 events (a few meters only before jet fan almost under)    |
| Gx060037-3  | 00:03:28 |                    | Arcing Between OCR and Pantograph 2 events (a few meters only after 2nd jet fan almost under) |
| Gx060037-3  | 00:03:33 |                    | East Tunnel Portal  |

| Video File: | ~Time    | ~Location        | Observation   |
|-------------|----------|------------------|---|
| Gx060037-5  | 00:03:42 | S2-E-9           | Pantograph horn scraping on crossover CW                                      |
| Gx060037-5  | 00:03:45 | S2-E-10          | Pantograph horn scraping on crossover CW                                      |
| Gx060037-5  | 00:03:58 | S3-C-3           | Cut-in insulation in MW   |
| Gx060037-3  | 00:04:09 |                  | uOttawa Station   |
| Gx060037-5  | 00:04:52 | S3-C-3-2         | Clicking sound at mid-span  |
| Gx060037-5  | 00:05:35 | S3-C-22-1        | Three drop pipes are installed either end of the bridge - not as per as-built |
| Gx060037-3  | 00:05:52 | Lees Station     |   |
| Gx060037-5  | 00:06:30 | S3-C-23-2        | Clicking sound at mid-span  |
| Gx060037-5  | 00:07:56 | Hurdman Stn      |   |
| Gx060037-5  | 00:08:33 | S3-C-45-2        | Clicking sound at registration  |
| Gx060037-6  | 00:00:01 | S3-C-51          | Clicking sound at registration  |
| Gx060037-6  | 00:00:08 | S3-C-54          | Clicking sound at registration  |
| Gx060037-6  | 00:00:16 | S4-E-3           | Pantograph horn scraping on crossover CW                                      |
| Gx060037-6  | 00:00:33 | S4-C-11          | Pantograph passage over SI noisy  |
| Gx060037-6  | 00:00:53 | S4-C-19          | Pantograph horn scraping on crossover CW                                      |
| Gx060037-6  | 00:01:02 | S4-C-22          | Clicking sound at registration  |
| Gx060037-6  | 00:01:10 | S4-C-25          | Clicking sound towards end of span  |
| Gx060037-6  | 00:01:17 | S4-C-27          | Clicking sound towards end of span  |
| Gx060037-6  | 00:01:33 | Tremblay Station |   |
| Gx060037-6  | 00:02:44 | S4-C-39          | Clicking sound towards end of span  |
| Gx060037-6  | 00:02:45 | S4-C-40          | Pantograph passage over SI noisy  |
| Gx060037-6  | 00:02:45 | S4-C-41          | West bound OCS - no weight on dropper   |
| Gx060037-6  | 00:02:59 | S4-E-48          | Pantograph horn scraping on MSF lead CW                                       |
| Gx060037-6  | 00:03:13 | S4-E-54          | Clicking sound at start of span   |
| Gx060037-6  | 00:03:13 | S4-E-54          | Pantograph horn scraping on MSF lead CW                                       |

| Video File: | ~Time    | ~Location              | Observation   |
|-------------|----------|------------------------|---|
| Gx060037-6  | 00:03:34 | S4-E-66                | Pantograph horn scraping on crossover CW  |
| Gx060037-6  | 00:03:46 | St-Laurent Portal West |   |
| Gx060037-6  | 00:03:45 | S5-T-E-7               | Arcing at OCR overlap   |
| Gx060037-6  | 00:04:03 | S5-T-E-??              | Arcing at OCR overlap (not on as-built drawing)                                       |
| Gx060037-6  | 00:04:15 | St-Laurent Station     |   |
| Gx060037-6  | 00:04:53 | S5-T-E-??              | Arcing along OCR (prior to jet fans)  |
| Gx060037-6  | 00:04:56 | S5-T-E-??              | Arcing along OCR 1 event  |
| Gx060037-6  | 00:05:00 | S5-T-E-??              | Arcing along OCR at overlap before transition (overlap not shown on as-built drawing) |
| Gx060037-6  | 00:03:46 | St-Laurent East Portal |   |
| Gx060037-6  | 00:05:34 | S5-C-11                | Clicking sound at registration  |
| Gx060037-6  | 00:05:50 | S5-E-18                | Clicking sound at start of span   |
| Gx060037-6  | 00:04:15 | Cyrville Station       |   |
| Gx060037-6  | 00:06:41 | S5-E-19-2              | Clicking sound at start of span   |
| Gx060037-6  | 00:06:52 | S5-C-23                | Clicking sound at registration  |
| Gx060037-6  | 00:06:53 | S5-C-24                | Clicking sound at registration  |
| Gx060037-6  | 00:06:55 | S5-C-25                | Clicking sound at registration  |
| Gx060037-6  | 00:06:58 | S5-C-26                | Clicking sound at registration  |
| Gx060037-6  | 00:07:00 | S5-C-27                | Clicking sound at registration  |
| Gx060037-6  | 00:07:02 | S5-C-28                | Clicking sound at registration  |
| Gx060037-6  | 00:08:08 | S5-E-53                | Clicking sound adjacent SI  |
| Gx060037-6  | 00:08:11 | S5-C-54                | Clicking sound at registration  |
| Gx060037-6  | 00:08:14 | S5-C-54                | Clicking sound at registration  |
| Gx060037-6  | 00:08:16 | S5-C-55                | Clicking sound in span near dropper before jumper wire                                |
| Gx060037-6  | 00:08:29 | S5-C-57                | SI stagger >350mm, arcing   |



| Video File: | ~Time    | ~Location | Observation   |
|-------------|----------|-----------|---|
| Gx060037-6  | 00:08:35 | S5-E-59   | Clicking sound where Westbound wire comes in running  |
| Gx060037-6  | 00:08:35 | S5-W-61   | Clicking sound where crossover wire goes out of running   |
| General     |          |           | Registration tubes in pull-off cantilevers on curves not horizontal                                   |
| General     |          |           | Single jumper wire at some overlaps and crossovers  |
| General     |          |           | Staggers and mid-span offsets > 300mm   |
| General     |          |           | Feeder wires are only connected to the MW   |
| General     |          |           | Constant staggers for OCR   |
| General     |          |           | In-span jumpers installed wrong way for direction of travel   |
| General     |          |           | Catenary wire is not over the CW or, alternatively, over the centre of the track on tangent sections. |
| General     |          |           | Jumper wires appear too tight or slack - too short/long   |
| General     |          |           | There does not appear to be a connection between the MW and OCR at the transitions                    |
| General     |          |           | OCR not at constant height  |
| General     |          |           | OCR arcing in many locations  |
| General     |          |           | Zero CW staggers, especially in platforms   |
| General     |          |           | Several supports not bonded to the aerial grounding wire  |

**Table D.3: Videos from GoProVideos.zip file September 2020 – Route details**

| Video File: | From                | To                        | Route & Pantograph View                            |
|-------------|---------------------|---------------------------|--|
| GH010018    | MSF Building        |                           | LRV Sat in MSF building - nothing to review        |
| GH020018    | MSF Building        | MSF SIW                   | LRV into Yard and back to Wash road                |
| GH030018    | SIW                 | EOL                       | Wash road - Westbound looking backwards            |
| GH040018    | Rideau station      | Hinchey Ave (nr TP sta.)  | Westbound looking backwards                        |
| GH010020    | MSF Building        |                           | LRV Sat in MSF building - nothing to review        |
| GH060020    | Bayview station     | Parkdale Ave (nr TP sta.) | Westbound looking forwards - nothing new to review |
| GH070004    | West of Rideau sta. | East of Rideau sta.       | East bound looking forwards                        |

This report has been developed under a privileged and confidential assignment on behalf of the City of Ottawa. While the report has been prepared for release to City Council as requested by the City and counsel to the City, neither the City nor its' counsel waive privilege over the overall assignment.

**Table D.4: Videos from GoProVideos.zip file September 2020 – OCS observations**

| Video File: | ~Time    | ~Location | Observation  |
|-------------|----------|-----------|--|
| GH020018    | 00:07:22 |           | SI incorrectly set   |
| GH020018    | 00:07:22 |           | SI not set at zero stagger   |
| GH020018    | 00:08:06 |           | Poor takeover, CW hitting pantograph horn                              |
| GH020018    | 00:08:13 |           | Continuity jumper appears 'birdcaged'                                  |
| GH020018    | 00:09:11 |           | SI incorrectly set   |
| GH020018    | 00:09:45 |           | Excessive MSO  |
| GH020018    | 00:10:02 |           | SI incorrectly set   |
| GH020018    | 00:10:02 |           | SI not set at zero stagger   |
| GH020018    | 00:11:43 |           | LRV reverses direction on same route                                   |
| GH020018    | 00:12:31 |           | LRV changes route towards washplant                                    |
| GH020018    | 00:12:34 |           | Poor takeover, CW hitting pantograph horn                              |
| GH020018    | 00:13:23 |           | Top ite on cantilever appear unloaded                                  |
| GH020018    | 00:13:55 |           | SI incorrectly set   |
| GH020018    | 00:13:55 |           | SI incorrectly set   |
| GH030018    | 00:01:42 |           | Insulator in OOR CW in pantograph zone                                 |
| GH030018    | 00:01:46 |           | Poor takeover, CW hitting pantograph horn                              |
| GH030018    | 00:01:52 |           | Poor takeover, CW hitting pantograph horn                              |
| GH030018    | 00:02:23 |           | OOR Cantilever Parafil rope nose dropper loose                         |
| GH030018    | 00:02:23 |           | No connection from ML equipment to OOR CW                              |
| GH030018    | 00:02:27 |           | Appears to be hangers missing from the catenary equipment, both tracks |
| GH030018    | 00:02:36 |           | Feeder wire for ML equipment should be attached to MW and jumper to CW |
| GH030018    | 00:02:36 |           | No connection from ML equipment to OOR CW                              |
| GH030018    | 00:02:37 |           | Hanger slack on opposite track   |
| GH030018    | 00:02:41 |           | Hangers slack on opposite track  |
| GH030018    | 00:02:43 |           | Hangers slack on opposite track  |
| GH030018    | 00:02:46 |           | Hanger slack   |
| GH030018    | 00:02:47 |           | OOR Cantilever Parafil rope nose dropper loose on both tracks          |
| GH030018    | 00:02:47 |           | Hanger slack   |
| GH030018    | 00:02:50 |           | Hanger slack and jumper appears tight                                  |
| GH030018    | 00:02:52 |           | Hanger slack   |
| GH030018    | 00:02:53 |           | OOR Cantilever Parafil rope nose dropper loose on both tracks          |
| GH030018    | 00:03:10 |           | MW not connected to the OCR  |
| GH030018    | 00:03:23 |           | Poor takeover at end of OCR overlap                                    |
| GH030018    | 00:06:26 |           | MW not connected to the OCR  |
| GH030018    | 00:06:30 |           | SI incorrectly set   |
| GH030018    | 00:06:48 |           | SI incorrectly set   |
| GH030018    | 00:06:51 |           | Should have two jumper wires between OCS equipment                     |
| GH030018    | 00:06:55 |           | Back guy pole bracket twisted  |
| GH030018    | 00:06:59 |           | Mid-point 'Z' wire appears too taut                                    |
| GH030018    | 00:06:59 |           | Mid-point 'Z' wire appears too slack                                   |

This report has been developed under a privileged and confidential assignment on behalf of the City of Ottawa. While the report has been prepared for release to City Council as requested by the City and counsel to the City, neither the City nor its' counsel waive privilege over the overall assignment.

| Video File: | ~Time    | ~Location | Observation   |
|-------------|----------|-----------|---|
| GH030018    | 00:07:03 |           | SI incorrectly set  |
| GH030018    | 00:07:31 |           | Arcing between pantograph and OCS   |
| GH030018    | 00:07:39 |           | Arcing between pantograph and OCS   |
| GH030018    | 00:15:18 |           | Cut-in insulation in MW - both sides  |
| GH030018    | 00:15:55 |           | Uneven height of OCR  |
| GH030018    | 00:16:00 |           | Arcing between OCR and pantograph in overlap area                                     |
| GH030018    | 00:16:00 |           | Poor takeover at end of OCR overlap   |
| GH030018    | 00:16:21 |           | Poor takeover at end of OCR overlap   |
| GH040018    | 00:00:38 |           | Arcing between OCR and pantograph   |
| GH040018    | 00:00:39 |           | Arcing between OCR and pantograph   |
| GH040018    | 00:00:43 |           | Arcing between OCR and pantograph   |
| GH040018    | 00:00:44 |           | Arcing between OCR and pantograph through overlap                                     |
| GH040018    | 00:00:44 |           | Poor takeover through OCR overlap   |
| GH040018    | 00:00:58 |           | Uneven height of OCR  |
| GH040018    | 00:01:02 |           | Uneven height of OCR and arcing   |
| GH040018    | 00:01:59 |           | Arcing between OCR and pantograph through overlap                                     |
| GH040018    | 00:01:59 |           | Poor takeover through OCR overlap   |
| GH040018    | 00:02:01 |           | Arcing between OCR and pantograph at support location                                 |
| GH040018    | 00:03:32 |           | Arcing between OCR and pantograph   |
| GH040018    | 00:03:33 |           | Arcing between OCR and pantograph through overlap                                     |
| GH040018    | 00:03:33 |           | Poor takeover through OCR overlap   |
| GH040018    | 00:03:34 |           | Arcing between OCR and pantograph   |
| GH040018    | 00:03:41 |           | Arcing between OCR and pantograph   |
| GH040018    | 00:03:43 |           | Arcing between OCR and pantograph through overlap                                     |
| GH040018    | 00:03:43 |           | Poor takeover through OCR overlap   |
| GH040018    | 00:04:09 |           | Poor takeover at end of OCR overlap   |
| GH040018    | 00:04:38 |           | Scraping sound as pantograph passess through overlap                                  |
| GH040018    | 00:04:40 |           | MW not connected to the OCR   |
| GH040018    | 00:04:47 |           | Excessive mid-span offset   |
| GH040018    | 00:07:48 |           | Excessive mid-span offset   |
| GH070004    | 00:00:04 |           | Excessive arcing between OCR and pantograph   |
| GH070004    | 00:00:10 |           | Minor arcing at end of OCR overlap  |
| GH070004    | 00:01:29 |           | Minor arcing  |
| GH070004    | 00:01:33 |           | Minor arcing at end of OCR overlap  |
| GH070004    | 00:01:35 |           | Excessive change in height of the OCR, at the cantilever support                      |
| General     |          |           | No hangers installed in anchor spans  |
| General     |          |           | Full-section jumper wires to be reviewed where only one has been installed            |
| General     |          |           | In-span jumpers should be uninsulated   |
| General     |          |           | In-span jumpers installed facing wrong direction                                      |
| General     |          |           | Very little stagger change on OCR sections  |
| General     |          |           | Hangers slack   |
| General     |          |           | Parafil rope ends not sheathed in MSF area or covered areas (stations, tunnels, etc.) |

This report has been developed under a privileged and confidential assignment on behalf of the City of Ottawa. While the report has been prepared for release to City Council as requested by the City and counsel to the City, neither the City nor its' counsel waive privilege over the overall assignment.

| Video File: | ~Time | ~Location | Observation                                |
|-------------|-------|-----------|--|
| General     |       |           | Varying height of OCR                      |
| General     |       |           | Very little stagger change on OCR sections |



Figure E.2: Maintenance document – Page 19 (Extract)

|   |  |   |                    |
|---|--|---|--------------------|
|  | <b>6M-PREV-OCS TENSIONING<br/>DEVICES AND FIXED<br/>TERMINALS INSPECTION</b> | Document Reference:                             | Application date : |
|   |  | <b>OTT-OCS-MTN10-WMS-<br/>002</b><br>Revision A | 01/11/2018         |

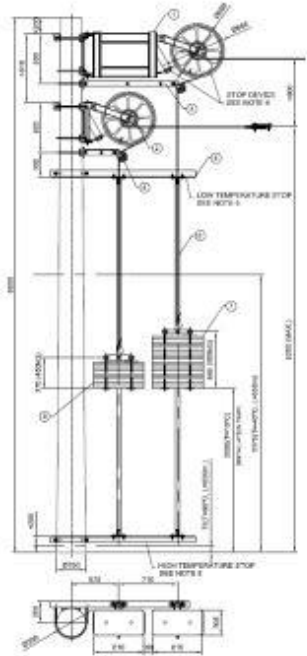
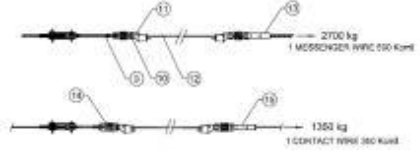

| No.   | Main Steps   | Operation Description   |   |  |  |  |      |          |               |      |   |   |                               |           |   |   |                               |           |   |   |                                     |                |   |   |                                     |                |   |   |                             |         |   |   |                     |   |   |   |  |            |   |   |  |            |   |   |                                 |            |    |   |                        |        |    |   |  |        |    |    |                               |       |    |   |                             |           |    |   |                        |          |    |   |                             |           |
|---|--|---|---|--|--|--|------|----------|---------------|------|---|---|-------------------------------|-----------|---|---|-------------------------------|-----------|---|---|-------------------------------------|----------------|---|---|-------------------------------------|----------------|---|---|-----------------------------|---------|---|---|---------------------|---|---|---|--|------------|---|---|--|------------|---|---|---------------------------------|------------|----|---|------------------------|--------|----|---|--|--------|----|----|-------------------------------|-------|----|---|-----------------------------|-----------|----|---|------------------------|----------|----|---|-----------------------------|-----------|
| <b>G. Balance weight 2 Tension Wheels 1/3 Steel Blocks Inspection</b>           |  |   |   |  |  |  |      |          |               |      |   |   |                               |           |   |   |                               |           |   |   |                                     |                |   |   |                                     |                |   |   |                             |         |   |   |                     |   |   |   |  |            |   |   |  |            |   |   |                                 |            |    |   |                        |        |    |   |  |        |    |    |                               |       |    |   |                             |           |    |   |                        |          |    |   |                             |           |
| 1   | <b>Inspect<br/>Balance<br/>weight<br/>Assembly</b> | <p>a. Inspect Balance Weight assembly if you see or find some damages on each component,</p> <p>b. Verify bolting, replace or tighten if necessary.</p> <div style="text-align: center;">  <p><b>Balance Weight 2 Tension Wheels 1/3 Steel Blocks</b></p>  </div> <table border="1"> <thead> <tr> <th colspan="4">BALANCE WEIGHT ASSEMBLY 2 TENSION WHEELS - 305x305 + 610x305 STEEL BLOCKS QTY=6</th> </tr> <tr> <th>ITEM</th> <th>QUANTITY</th> <th>DE NOMINATION</th> <th>REF.</th> </tr> </thead> <tbody> <tr> <td>1</td> <td>1</td> <td>MW TENSION WHEEL 1/3 ASSEMBLY</td> <td>MW-TW-ASS</td> </tr> <tr> <td>2</td> <td>1</td> <td>CW TENSION WHEEL 1/3 ASSEMBLY</td> <td>CW-TW-ASS</td> </tr> <tr> <td>3</td> <td>1</td> <td>MW PULLEY SYSTEM ASSEMBLY 610 BLOCK</td> <td>PUL-ASS-MW-610</td> </tr> <tr> <td>4</td> <td>1</td> <td>CW PULLEY SYSTEM ASSEMBLY 610 BLOCK</td> <td>PUL-ASS-CW-610</td> </tr> <tr> <td>5</td> <td>2</td> <td>2 GUIDE BRACKET - 610 BLOCK</td> <td>GB2-610</td> </tr> <tr> <td>6</td> <td>2</td> <td>COUNTERWEIGHT GUARD</td> <td>-</td> </tr> <tr> <td>7</td> <td>1</td> <td>305kg. COUNTERWEIGHT ASSEMBLY 610X305 (STEEL PLATES 50 kg)</td> <td>305-CW-610</td> </tr> <tr> <td>8</td> <td>1</td> <td>406kg. COUNTERWEIGHT ASSEMBLY 610X305 (STEEL PLATES 50 kg)</td> <td>405-CW-610</td> </tr> <tr> <td>9</td> <td>1</td> <td>TURNBUCKLE L-11 M16 EYE-JAW 306</td> <td>T-L11-LH-0</td> </tr> <tr> <td>10</td> <td>4</td> <td>LOOP SILICON INSULATOR</td> <td>22101E</td> </tr> <tr> <td>11</td> <td>4</td> <td>WEDGE TYPE TERMINAL FOR 24 MM. STEEL CABLE</td> <td>212122</td> </tr> <tr> <td>12</td> <td>25</td> <td>ø 19.9 mm. ANTI-TENSION CABLE</td> <td>CB A3</td> </tr> <tr> <td>13</td> <td>1</td> <td>FORKED COLLAR SOCKET FOR MW</td> <td>GA-MW-353</td> </tr> <tr> <td>14</td> <td>1</td> <td>TURNBUCKLE EYE-JAW 315</td> <td>T-AH-150</td> </tr> <tr> <td>15</td> <td>1</td> <td>FORKED COLLAR SOCKET FOR CW</td> <td>GA-CW-178</td> </tr> </tbody> </table> | BALANCE WEIGHT ASSEMBLY 2 TENSION WHEELS - 305x305 + 610x305 STEEL BLOCKS QTY=6 |  |  |  | ITEM | QUANTITY | DE NOMINATION | REF. | 1 | 1 | MW TENSION WHEEL 1/3 ASSEMBLY | MW-TW-ASS | 2 | 1 | CW TENSION WHEEL 1/3 ASSEMBLY | CW-TW-ASS | 3 | 1 | MW PULLEY SYSTEM ASSEMBLY 610 BLOCK | PUL-ASS-MW-610 | 4 | 1 | CW PULLEY SYSTEM ASSEMBLY 610 BLOCK | PUL-ASS-CW-610 | 5 | 2 | 2 GUIDE BRACKET - 610 BLOCK | GB2-610 | 6 | 2 | COUNTERWEIGHT GUARD | - | 7 | 1 | 305kg. COUNTERWEIGHT ASSEMBLY 610X305 (STEEL PLATES 50 kg) | 305-CW-610 | 8 | 1 | 406kg. COUNTERWEIGHT ASSEMBLY 610X305 (STEEL PLATES 50 kg) | 405-CW-610 | 9 | 1 | TURNBUCKLE L-11 M16 EYE-JAW 306 | T-L11-LH-0 | 10 | 4 | LOOP SILICON INSULATOR | 22101E | 11 | 4 | WEDGE TYPE TERMINAL FOR 24 MM. STEEL CABLE | 212122 | 12 | 25 | ø 19.9 mm. ANTI-TENSION CABLE | CB A3 | 13 | 1 | FORKED COLLAR SOCKET FOR MW | GA-MW-353 | 14 | 1 | TURNBUCKLE EYE-JAW 315 | T-AH-150 | 15 | 1 | FORKED COLLAR SOCKET FOR CW | GA-CW-178 |
| BALANCE WEIGHT ASSEMBLY 2 TENSION WHEELS - 305x305 + 610x305 STEEL BLOCKS QTY=6 |  |   |   |  |  |  |      |          |               |      |   |   |                               |           |   |   |                               |           |   |   |                                     |                |   |   |                                     |                |   |   |                             |         |   |   |                     |   |   |   |  |            |   |   |  |            |   |   |                                 |            |    |   |                        |        |    |   |  |        |    |    |                               |       |    |   |                             |           |    |   |                        |          |    |   |                             |           |
| ITEM  | QUANTITY   | DE NOMINATION   | REF.  |  |  |  |      |          |               |      |   |   |                               |           |   |   |                               |           |   |   |                                     |                |   |   |                                     |                |   |   |                             |         |   |   |                     |   |   |   |  |            |   |   |  |            |   |   |                                 |            |    |   |                        |        |    |   |  |        |    |    |                               |       |    |   |                             |           |    |   |                        |          |    |   |                             |           |
| 1   | 1  | MW TENSION WHEEL 1/3 ASSEMBLY   | MW-TW-ASS   |  |  |  |      |          |               |      |   |   |                               |           |   |   |                               |           |   |   |                                     |                |   |   |                                     |                |   |   |                             |         |   |   |                     |   |   |   |  |            |   |   |  |            |   |   |                                 |            |    |   |                        |        |    |   |  |        |    |    |                               |       |    |   |                             |           |    |   |                        |          |    |   |                             |           |
| 2   | 1  | CW TENSION WHEEL 1/3 ASSEMBLY   | CW-TW-ASS   |  |  |  |      |          |               |      |   |   |                               |           |   |   |                               |           |   |   |                                     |                |   |   |                                     |                |   |   |                             |         |   |   |                     |   |   |   |  |            |   |   |  |            |   |   |                                 |            |    |   |                        |        |    |   |  |        |    |    |                               |       |    |   |                             |           |    |   |                        |          |    |   |                             |           |
| 3   | 1  | MW PULLEY SYSTEM ASSEMBLY 610 BLOCK   | PUL-ASS-MW-610  |  |  |  |      |          |               |      |   |   |                               |           |   |   |                               |           |   |   |                                     |                |   |   |                                     |                |   |   |                             |         |   |   |                     |   |   |   |  |            |   |   |  |            |   |   |                                 |            |    |   |                        |        |    |   |  |        |    |    |                               |       |    |   |                             |           |    |   |                        |          |    |   |                             |           |
| 4   | 1  | CW PULLEY SYSTEM ASSEMBLY 610 BLOCK   | PUL-ASS-CW-610  |  |  |  |      |          |               |      |   |   |                               |           |   |   |                               |           |   |   |                                     |                |   |   |                                     |                |   |   |                             |         |   |   |                     |   |   |   |  |            |   |   |  |            |   |   |                                 |            |    |   |                        |        |    |   |  |        |    |    |                               |       |    |   |                             |           |    |   |                        |          |    |   |                             |           |
| 5   | 2  | 2 GUIDE BRACKET - 610 BLOCK   | GB2-610   |  |  |  |      |          |               |      |   |   |                               |           |   |   |                               |           |   |   |                                     |                |   |   |                                     |                |   |   |                             |         |   |   |                     |   |   |   |  |            |   |   |  |            |   |   |                                 |            |    |   |                        |        |    |   |  |        |    |    |                               |       |    |   |                             |           |    |   |                        |          |    |   |                             |           |
| 6   | 2  | COUNTERWEIGHT GUARD   | -   |  |  |  |      |          |               |      |   |   |                               |           |   |   |                               |           |   |   |                                     |                |   |   |                                     |                |   |   |                             |         |   |   |                     |   |   |   |  |            |   |   |  |            |   |   |                                 |            |    |   |                        |        |    |   |  |        |    |    |                               |       |    |   |                             |           |    |   |                        |          |    |   |                             |           |
| 7   | 1  | 305kg. COUNTERWEIGHT ASSEMBLY 610X305 (STEEL PLATES 50 kg)  | 305-CW-610  |  |  |  |      |          |               |      |   |   |                               |           |   |   |                               |           |   |   |                                     |                |   |   |                                     |                |   |   |                             |         |   |   |                     |   |   |   |  |            |   |   |  |            |   |   |                                 |            |    |   |                        |        |    |   |  |        |    |    |                               |       |    |   |                             |           |    |   |                        |          |    |   |                             |           |
| 8   | 1  | 406kg. COUNTERWEIGHT ASSEMBLY 610X305 (STEEL PLATES 50 kg)  | 405-CW-610  |  |  |  |      |          |               |      |   |   |                               |           |   |   |                               |           |   |   |                                     |                |   |   |                                     |                |   |   |                             |         |   |   |                     |   |   |   |  |            |   |   |  |            |   |   |                                 |            |    |   |                        |        |    |   |  |        |    |    |                               |       |    |   |                             |           |    |   |                        |          |    |   |                             |           |
| 9   | 1  | TURNBUCKLE L-11 M16 EYE-JAW 306   | T-L11-LH-0  |  |  |  |      |          |               |      |   |   |                               |           |   |   |                               |           |   |   |                                     |                |   |   |                                     |                |   |   |                             |         |   |   |                     |   |   |   |  |            |   |   |  |            |   |   |                                 |            |    |   |                        |        |    |   |  |        |    |    |                               |       |    |   |                             |           |    |   |                        |          |    |   |                             |           |
| 10  | 4  | LOOP SILICON INSULATOR  | 22101E  |  |  |  |      |          |               |      |   |   |                               |           |   |   |                               |           |   |   |                                     |                |   |   |                                     |                |   |   |                             |         |   |   |                     |   |   |   |  |            |   |   |  |            |   |   |                                 |            |    |   |                        |        |    |   |  |        |    |    |                               |       |    |   |                             |           |    |   |                        |          |    |   |                             |           |
| 11  | 4  | WEDGE TYPE TERMINAL FOR 24 MM. STEEL CABLE  | 212122  |  |  |  |      |          |               |      |   |   |                               |           |   |   |                               |           |   |   |                                     |                |   |   |                                     |                |   |   |                             |         |   |   |                     |   |   |   |  |            |   |   |  |            |   |   |                                 |            |    |   |                        |        |    |   |  |        |    |    |                               |       |    |   |                             |           |    |   |                        |          |    |   |                             |           |
| 12  | 25   | ø 19.9 mm. ANTI-TENSION CABLE   | CB A3   |  |  |  |      |          |               |      |   |   |                               |           |   |   |                               |           |   |   |                                     |                |   |   |                                     |                |   |   |                             |         |   |   |                     |   |   |   |  |            |   |   |  |            |   |   |                                 |            |    |   |                        |        |    |   |  |        |    |    |                               |       |    |   |                             |           |    |   |                        |          |    |   |                             |           |
| 13  | 1  | FORKED COLLAR SOCKET FOR MW   | GA-MW-353   |  |  |  |      |          |               |      |   |   |                               |           |   |   |                               |           |   |   |                                     |                |   |   |                                     |                |   |   |                             |         |   |   |                     |   |   |   |  |            |   |   |  |            |   |   |                                 |            |    |   |                        |        |    |   |  |        |    |    |                               |       |    |   |                             |           |    |   |                        |          |    |   |                             |           |
| 14  | 1  | TURNBUCKLE EYE-JAW 315  | T-AH-150  |  |  |  |      |          |               |      |   |   |                               |           |   |   |                               |           |   |   |                                     |                |   |   |                                     |                |   |   |                             |         |   |   |                     |   |   |   |  |            |   |   |  |            |   |   |                                 |            |    |   |                        |        |    |   |  |        |    |    |                               |       |    |   |                             |           |    |   |                        |          |    |   |                             |           |
| 15  | 1  | FORKED COLLAR SOCKET FOR CW   | GA-CW-178   |  |  |  |      |          |               |      |   |   |                               |           |   |   |                               |           |   |   |                                     |                |   |   |                                     |                |   |   |                             |         |   |   |                     |   |   |   |  |            |   |   |  |            |   |   |                                 |            |    |   |                        |        |    |   |  |        |    |    |                               |       |    |   |                             |           |    |   |                        |          |    |   |                             |           |



Figure E.3: Maintenance Document – Page 20 (Extract)

|   |  |   |                    |
|---|--|---|--------------------|
|  | <b>6M-PREV-OCS TENSIONING<br/>DEVICES AND FIXED<br/>TERMINALS INSPECTION</b> | Document Reference:                             | Application date : |
|   |  | <b>OTT-OCS-MTN10-WMS-<br/>002</b><br>Revision A | 01/11/2018         |

| No.                 | Main Steps                                       | Operation Description  |                     |      |      |      |      |      |      |      |      |      |   |     |            |   |                   |         |  |                  |  |  |  |  |  |  |  |  |  |  |          |  |            |  |     |     |     |     |   |    |    |    |    |    |    |    |    |            |  |                   |     |  |      |      |      |      |      |      |      |      |      |      |      |     |     |      |  |      |     |  |      |      |      |      |      |      |      |      |      |      |      |     |     |      |  |    |     |  |      |      |      |      |      |      |      |      |      |      |     |     |     |      |  |      |     |  |      |      |      |      |      |      |      |      |      |      |     |     |    |      |  |    |                |  |  |  |  |  |  |  |  |  |  |  |  |   |  |         |  |                  |  |  |  |  |  |  |  |  |  |  |          |  |            |  |     |     |     |     |   |    |    |    |    |    |    |    |    |            |  |                   |     |  |      |      |      |      |      |      |      |      |      |      |     |     |     |      |  |    |     |  |      |      |      |      |      |      |      |      |      |     |     |     |    |      |  |      |
|---------------------|--|--|---------------------|------|------|------|------|------|------|------|------|------|---|-----|------------|---|-------------------|---------|--|------------------|--|--|--|--|--|--|--|--|--|--|----------|--|------------|--|-----|-----|-----|-----|---|----|----|----|----|----|----|----|----|------------|--|-------------------|-----|--|------|------|------|------|------|------|------|------|------|------|------|-----|-----|------|--|------|-----|--|------|------|------|------|------|------|------|------|------|------|------|-----|-----|------|--|----|-----|--|------|------|------|------|------|------|------|------|------|------|-----|-----|-----|------|--|------|-----|--|------|------|------|------|------|------|------|------|------|------|-----|-----|----|------|--|----|----------------|--|--|--|--|--|--|--|--|--|--|--|--|---|--|---------|--|------------------|--|--|--|--|--|--|--|--|--|--|----------|--|------------|--|-----|-----|-----|-----|---|----|----|----|----|----|----|----|----|------------|--|-------------------|-----|--|------|------|------|------|------|------|------|------|------|------|-----|-----|-----|------|--|----|-----|--|------|------|------|------|------|------|------|------|------|-----|-----|-----|----|------|--|------|
| 2                   | <b>Verify<br/>Balance<br/>Weight<br/>Setting</b> | <p>a. Measure "h" Height from ground to counterweights(mm)</p> <p>b. Compare the values with temperature table.</p> <table border="1" style="width: 100%; border-collapse: collapse; font-size: 8px;"> <thead> <tr> <th colspan="13" style="text-align: center;">POLES H1-2,2 - 6,2m</th> <th colspan="2" style="text-align: center;">MEASURE "h" HEIGHT FROM GROUND TO COUNTERWEIGHTS [mm]</th> </tr> <tr> <th colspan="2" style="text-align: center;">TENSION</th> <th colspan="11" style="text-align: center;">TEMPERATURE [°C]</th> <th colspan="2" style="text-align: center;">MOVEMENT</th> </tr> <tr> <th colspan="2" style="text-align: center;">LENGTH [m]</th> <th>-40</th><th>-38</th><th>-20</th><th>-18</th><th>0</th><th>12</th><th>20</th><th>36</th><th>40</th><th>58</th><th>60</th><th>70</th><th>80</th> <th colspan="2" style="text-align: center;">RANGE [mm]</th> <th colspan="1" style="text-align: center;">INTERMEDIATE TEMP</th> </tr> </thead> <tbody> <tr> <td colspan="2" style="text-align: center;">500</td> <td>4850</td><td>4120</td><td>3050</td><td>2675</td><td>1520</td><td>2825</td><td>2950</td><td>2175</td><td>2850</td><td>1320</td><td>1250</td><td>875</td><td>550</td> <td colspan="2" style="text-align: center;">3000</td> <td style="text-align: center;">20,5</td> </tr> <tr> <td colspan="2" style="text-align: center;">700</td> <td>4575</td><td>4025</td><td>3675</td><td>2525</td><td>1675</td><td>2825</td><td>2475</td><td>2125</td><td>1775</td><td>1625</td><td>1075</td><td>725</td><td>375</td> <td colspan="2" style="text-align: center;">4200</td> <td style="text-align: center;">20</td> </tr> <tr> <td colspan="2" style="text-align: center;">750</td> <td>4740</td><td>4025</td><td>3050</td><td>2575</td><td>1500</td><td>2825</td><td>2475</td><td>2125</td><td>1775</td><td>1325</td><td>950</td><td>575</td><td>200</td> <td colspan="2" style="text-align: center;">4500</td> <td style="text-align: center;">27,5</td> </tr> <tr> <td colspan="2" style="text-align: center;">800</td> <td>4825</td><td>4425</td><td>4025</td><td>3625</td><td>1325</td><td>2825</td><td>2425</td><td>2025</td><td>1625</td><td>1225</td><td>825</td><td>425</td><td>25</td> <td colspan="2" style="text-align: center;">4800</td> <td style="text-align: center;">26</td> </tr> </tbody> </table><br><table border="1" style="width: 100%; border-collapse: collapse; font-size: 8px;"> <thead> <tr> <th colspan="13" style="text-align: center;">16 C,26 (6,5m)</th> <th colspan="2" style="text-align: center;">MEASURE "h" HEIGHT FROM GROUND TO COUNTERWEIGHTS [mm]</th> </tr> <tr> <th colspan="2" style="text-align: center;">TENSION</th> <th colspan="11" style="text-align: center;">TEMPERATURE [°C]</th> <th colspan="2" style="text-align: center;">MOVEMENT</th> </tr> <tr> <th colspan="2" style="text-align: center;">LENGTH [m]</th> <th>-40</th><th>-38</th><th>-20</th><th>-18</th><th>0</th><th>12</th><th>20</th><th>36</th><th>40</th><th>58</th><th>60</th><th>70</th><th>80</th> <th colspan="2" style="text-align: center;">RANGE [mm]</th> <th colspan="1" style="text-align: center;">INTERMEDIATE TEMP</th> </tr> </thead> <tbody> <tr> <td colspan="2" style="text-align: center;">500</td> <td>2250</td><td>3000</td><td>2750</td><td>2500</td><td>2250</td><td>2000</td><td>1750</td><td>1500</td><td>1250</td><td>1000</td><td>750</td><td>500</td><td>250</td> <td colspan="2" style="text-align: center;">3000</td> <td style="text-align: center;">25</td> </tr> <tr> <td colspan="2" style="text-align: center;">550</td> <td>3175</td><td>3100</td><td>2825</td><td>2500</td><td>2275</td><td>2000</td><td>1725</td><td>1450</td><td>1175</td><td>900</td><td>625</td><td>350</td><td>75</td> <td colspan="2" style="text-align: center;">3300</td> <td style="text-align: center;">27,5</td> </tr> </tbody> </table> | POLES H1-2,2 - 6,2m |      |      |      |      |      |      |      |      |      |   |     |            | MEASURE "h" HEIGHT FROM GROUND TO COUNTERWEIGHTS [mm] |                   | TENSION |  | TEMPERATURE [°C] |  |  |  |  |  |  |  |  |  |  | MOVEMENT |  | LENGTH [m] |  | -40 | -38 | -20 | -18 | 0 | 12 | 20 | 36 | 40 | 58 | 60 | 70 | 80 | RANGE [mm] |  | INTERMEDIATE TEMP | 500 |  | 4850 | 4120 | 3050 | 2675 | 1520 | 2825 | 2950 | 2175 | 2850 | 1320 | 1250 | 875 | 550 | 3000 |  | 20,5 | 700 |  | 4575 | 4025 | 3675 | 2525 | 1675 | 2825 | 2475 | 2125 | 1775 | 1625 | 1075 | 725 | 375 | 4200 |  | 20 | 750 |  | 4740 | 4025 | 3050 | 2575 | 1500 | 2825 | 2475 | 2125 | 1775 | 1325 | 950 | 575 | 200 | 4500 |  | 27,5 | 800 |  | 4825 | 4425 | 4025 | 3625 | 1325 | 2825 | 2425 | 2025 | 1625 | 1225 | 825 | 425 | 25 | 4800 |  | 26 | 16 C,26 (6,5m) |  |  |  |  |  |  |  |  |  |  |  |  | MEASURE "h" HEIGHT FROM GROUND TO COUNTERWEIGHTS [mm] |  | TENSION |  | TEMPERATURE [°C] |  |  |  |  |  |  |  |  |  |  | MOVEMENT |  | LENGTH [m] |  | -40 | -38 | -20 | -18 | 0 | 12 | 20 | 36 | 40 | 58 | 60 | 70 | 80 | RANGE [mm] |  | INTERMEDIATE TEMP | 500 |  | 2250 | 3000 | 2750 | 2500 | 2250 | 2000 | 1750 | 1500 | 1250 | 1000 | 750 | 500 | 250 | 3000 |  | 25 | 550 |  | 3175 | 3100 | 2825 | 2500 | 2275 | 2000 | 1725 | 1450 | 1175 | 900 | 625 | 350 | 75 | 3300 |  | 27,5 |
| POLES H1-2,2 - 6,2m |  |  |                     |      |      |      |      |      |      |      |      |      | MEASURE "h" HEIGHT FROM GROUND TO COUNTERWEIGHTS [mm] |     |            |   |                   |         |  |                  |  |  |  |  |  |  |  |  |  |  |          |  |            |  |     |     |     |     |   |    |    |    |    |    |    |    |    |            |  |                   |     |  |      |      |      |      |      |      |      |      |      |      |      |     |     |      |  |      |     |  |      |      |      |      |      |      |      |      |      |      |      |     |     |      |  |    |     |  |      |      |      |      |      |      |      |      |      |      |     |     |     |      |  |      |     |  |      |      |      |      |      |      |      |      |      |      |     |     |    |      |  |    |                |  |  |  |  |  |  |  |  |  |  |  |  |   |  |         |  |                  |  |  |  |  |  |  |  |  |  |  |          |  |            |  |     |     |     |     |   |    |    |    |    |    |    |    |    |            |  |                   |     |  |      |      |      |      |      |      |      |      |      |      |     |     |     |      |  |    |     |  |      |      |      |      |      |      |      |      |      |     |     |     |    |      |  |      |
| TENSION             |  | TEMPERATURE [°C]   |                     |      |      |      |      |      |      |      |      |      | MOVEMENT  |     |            |   |                   |         |  |                  |  |  |  |  |  |  |  |  |  |  |          |  |            |  |     |     |     |     |   |    |    |    |    |    |    |    |    |            |  |                   |     |  |      |      |      |      |      |      |      |      |      |      |      |     |     |      |  |      |     |  |      |      |      |      |      |      |      |      |      |      |      |     |     |      |  |    |     |  |      |      |      |      |      |      |      |      |      |      |     |     |     |      |  |      |     |  |      |      |      |      |      |      |      |      |      |      |     |     |    |      |  |    |                |  |  |  |  |  |  |  |  |  |  |  |  |   |  |         |  |                  |  |  |  |  |  |  |  |  |  |  |          |  |            |  |     |     |     |     |   |    |    |    |    |    |    |    |    |            |  |                   |     |  |      |      |      |      |      |      |      |      |      |      |     |     |     |      |  |    |     |  |      |      |      |      |      |      |      |      |      |     |     |     |    |      |  |      |
| LENGTH [m]          |  | -40  | -38                 | -20  | -18  | 0    | 12   | 20   | 36   | 40   | 58   | 60   | 70  | 80  | RANGE [mm] |   | INTERMEDIATE TEMP |         |  |                  |  |  |  |  |  |  |  |  |  |  |          |  |            |  |     |     |     |     |   |    |    |    |    |    |    |    |    |            |  |                   |     |  |      |      |      |      |      |      |      |      |      |      |      |     |     |      |  |      |     |  |      |      |      |      |      |      |      |      |      |      |      |     |     |      |  |    |     |  |      |      |      |      |      |      |      |      |      |      |     |     |     |      |  |      |     |  |      |      |      |      |      |      |      |      |      |      |     |     |    |      |  |    |                |  |  |  |  |  |  |  |  |  |  |  |  |   |  |         |  |                  |  |  |  |  |  |  |  |  |  |  |          |  |            |  |     |     |     |     |   |    |    |    |    |    |    |    |    |            |  |                   |     |  |      |      |      |      |      |      |      |      |      |      |     |     |     |      |  |    |     |  |      |      |      |      |      |      |      |      |      |     |     |     |    |      |  |      |
| 500                 |  | 4850   | 4120                | 3050 | 2675 | 1520 | 2825 | 2950 | 2175 | 2850 | 1320 | 1250 | 875   | 550 | 3000       |   | 20,5              |         |  |                  |  |  |  |  |  |  |  |  |  |  |          |  |            |  |     |     |     |     |   |    |    |    |    |    |    |    |    |            |  |                   |     |  |      |      |      |      |      |      |      |      |      |      |      |     |     |      |  |      |     |  |      |      |      |      |      |      |      |      |      |      |      |     |     |      |  |    |     |  |      |      |      |      |      |      |      |      |      |      |     |     |     |      |  |      |     |  |      |      |      |      |      |      |      |      |      |      |     |     |    |      |  |    |                |  |  |  |  |  |  |  |  |  |  |  |  |   |  |         |  |                  |  |  |  |  |  |  |  |  |  |  |          |  |            |  |     |     |     |     |   |    |    |    |    |    |    |    |    |            |  |                   |     |  |      |      |      |      |      |      |      |      |      |      |     |     |     |      |  |    |     |  |      |      |      |      |      |      |      |      |      |     |     |     |    |      |  |      |
| 700                 |  | 4575   | 4025                | 3675 | 2525 | 1675 | 2825 | 2475 | 2125 | 1775 | 1625 | 1075 | 725   | 375 | 4200       |   | 20                |         |  |                  |  |  |  |  |  |  |  |  |  |  |          |  |            |  |     |     |     |     |   |    |    |    |    |    |    |    |    |            |  |                   |     |  |      |      |      |      |      |      |      |      |      |      |      |     |     |      |  |      |     |  |      |      |      |      |      |      |      |      |      |      |      |     |     |      |  |    |     |  |      |      |      |      |      |      |      |      |      |      |     |     |     |      |  |      |     |  |      |      |      |      |      |      |      |      |      |      |     |     |    |      |  |    |                |  |  |  |  |  |  |  |  |  |  |  |  |   |  |         |  |                  |  |  |  |  |  |  |  |  |  |  |          |  |            |  |     |     |     |     |   |    |    |    |    |    |    |    |    |            |  |                   |     |  |      |      |      |      |      |      |      |      |      |      |     |     |     |      |  |    |     |  |      |      |      |      |      |      |      |      |      |     |     |     |    |      |  |      |
| 750                 |  | 4740   | 4025                | 3050 | 2575 | 1500 | 2825 | 2475 | 2125 | 1775 | 1325 | 950  | 575   | 200 | 4500       |   | 27,5              |         |  |                  |  |  |  |  |  |  |  |  |  |  |          |  |            |  |     |     |     |     |   |    |    |    |    |    |    |    |    |            |  |                   |     |  |      |      |      |      |      |      |      |      |      |      |      |     |     |      |  |      |     |  |      |      |      |      |      |      |      |      |      |      |      |     |     |      |  |    |     |  |      |      |      |      |      |      |      |      |      |      |     |     |     |      |  |      |     |  |      |      |      |      |      |      |      |      |      |      |     |     |    |      |  |    |                |  |  |  |  |  |  |  |  |  |  |  |  |   |  |         |  |                  |  |  |  |  |  |  |  |  |  |  |          |  |            |  |     |     |     |     |   |    |    |    |    |    |    |    |    |            |  |                   |     |  |      |      |      |      |      |      |      |      |      |      |     |     |     |      |  |    |     |  |      |      |      |      |      |      |      |      |      |     |     |     |    |      |  |      |
| 800                 |  | 4825   | 4425                | 4025 | 3625 | 1325 | 2825 | 2425 | 2025 | 1625 | 1225 | 825  | 425   | 25  | 4800       |   | 26                |         |  |                  |  |  |  |  |  |  |  |  |  |  |          |  |            |  |     |     |     |     |   |    |    |    |    |    |    |    |    |            |  |                   |     |  |      |      |      |      |      |      |      |      |      |      |      |     |     |      |  |      |     |  |      |      |      |      |      |      |      |      |      |      |      |     |     |      |  |    |     |  |      |      |      |      |      |      |      |      |      |      |     |     |     |      |  |      |     |  |      |      |      |      |      |      |      |      |      |      |     |     |    |      |  |    |                |  |  |  |  |  |  |  |  |  |  |  |  |   |  |         |  |                  |  |  |  |  |  |  |  |  |  |  |          |  |            |  |     |     |     |     |   |    |    |    |    |    |    |    |    |            |  |                   |     |  |      |      |      |      |      |      |      |      |      |      |     |     |     |      |  |    |     |  |      |      |      |      |      |      |      |      |      |     |     |     |    |      |  |      |
| 16 C,26 (6,5m)      |  |  |                     |      |      |      |      |      |      |      |      |      | MEASURE "h" HEIGHT FROM GROUND TO COUNTERWEIGHTS [mm] |     |            |   |                   |         |  |                  |  |  |  |  |  |  |  |  |  |  |          |  |            |  |     |     |     |     |   |    |    |    |    |    |    |    |    |            |  |                   |     |  |      |      |      |      |      |      |      |      |      |      |      |     |     |      |  |      |     |  |      |      |      |      |      |      |      |      |      |      |      |     |     |      |  |    |     |  |      |      |      |      |      |      |      |      |      |      |     |     |     |      |  |      |     |  |      |      |      |      |      |      |      |      |      |      |     |     |    |      |  |    |                |  |  |  |  |  |  |  |  |  |  |  |  |   |  |         |  |                  |  |  |  |  |  |  |  |  |  |  |          |  |            |  |     |     |     |     |   |    |    |    |    |    |    |    |    |            |  |                   |     |  |      |      |      |      |      |      |      |      |      |      |     |     |     |      |  |    |     |  |      |      |      |      |      |      |      |      |      |     |     |     |    |      |  |      |
| TENSION             |  | TEMPERATURE [°C]   |                     |      |      |      |      |      |      |      |      |      | MOVEMENT  |     |            |   |                   |         |  |                  |  |  |  |  |  |  |  |  |  |  |          |  |            |  |     |     |     |     |   |    |    |    |    |    |    |    |    |            |  |                   |     |  |      |      |      |      |      |      |      |      |      |      |      |     |     |      |  |      |     |  |      |      |      |      |      |      |      |      |      |      |      |     |     |      |  |    |     |  |      |      |      |      |      |      |      |      |      |      |     |     |     |      |  |      |     |  |      |      |      |      |      |      |      |      |      |      |     |     |    |      |  |    |                |  |  |  |  |  |  |  |  |  |  |  |  |   |  |         |  |                  |  |  |  |  |  |  |  |  |  |  |          |  |            |  |     |     |     |     |   |    |    |    |    |    |    |    |    |            |  |                   |     |  |      |      |      |      |      |      |      |      |      |      |     |     |     |      |  |    |     |  |      |      |      |      |      |      |      |      |      |     |     |     |    |      |  |      |
| LENGTH [m]          |  | -40  | -38                 | -20  | -18  | 0    | 12   | 20   | 36   | 40   | 58   | 60   | 70  | 80  | RANGE [mm] |   | INTERMEDIATE TEMP |         |  |                  |  |  |  |  |  |  |  |  |  |  |          |  |            |  |     |     |     |     |   |    |    |    |    |    |    |    |    |            |  |                   |     |  |      |      |      |      |      |      |      |      |      |      |      |     |     |      |  |      |     |  |      |      |      |      |      |      |      |      |      |      |      |     |     |      |  |    |     |  |      |      |      |      |      |      |      |      |      |      |     |     |     |      |  |      |     |  |      |      |      |      |      |      |      |      |      |      |     |     |    |      |  |    |                |  |  |  |  |  |  |  |  |  |  |  |  |   |  |         |  |                  |  |  |  |  |  |  |  |  |  |  |          |  |            |  |     |     |     |     |   |    |    |    |    |    |    |    |    |            |  |                   |     |  |      |      |      |      |      |      |      |      |      |      |     |     |     |      |  |    |     |  |      |      |      |      |      |      |      |      |      |     |     |     |    |      |  |      |
| 500                 |  | 2250   | 3000                | 2750 | 2500 | 2250 | 2000 | 1750 | 1500 | 1250 | 1000 | 750  | 500   | 250 | 3000       |   | 25                |         |  |                  |  |  |  |  |  |  |  |  |  |  |          |  |            |  |     |     |     |     |   |    |    |    |    |    |    |    |    |            |  |                   |     |  |      |      |      |      |      |      |      |      |      |      |      |     |     |      |  |      |     |  |      |      |      |      |      |      |      |      |      |      |      |     |     |      |  |    |     |  |      |      |      |      |      |      |      |      |      |      |     |     |     |      |  |      |     |  |      |      |      |      |      |      |      |      |      |      |     |     |    |      |  |    |                |  |  |  |  |  |  |  |  |  |  |  |  |   |  |         |  |                  |  |  |  |  |  |  |  |  |  |  |          |  |            |  |     |     |     |     |   |    |    |    |    |    |    |    |    |            |  |                   |     |  |      |      |      |      |      |      |      |      |      |      |     |     |     |      |  |    |     |  |      |      |      |      |      |      |      |      |      |     |     |     |    |      |  |      |
| 550                 |  | 3175   | 3100                | 2825 | 2500 | 2275 | 2000 | 1725 | 1450 | 1175 | 900  | 625  | 350   | 75  | 3300       |   | 27,5              |         |  |                  |  |  |  |  |  |  |  |  |  |  |          |  |            |  |     |     |     |     |   |    |    |    |    |    |    |    |    |            |  |                   |     |  |      |      |      |      |      |      |      |      |      |      |      |     |     |      |  |      |     |  |      |      |      |      |      |      |      |      |      |      |      |     |     |      |  |    |     |  |      |      |      |      |      |      |      |      |      |      |     |     |     |      |  |      |     |  |      |      |      |      |      |      |      |      |      |      |     |     |    |      |  |    |                |  |  |  |  |  |  |  |  |  |  |  |  |   |  |         |  |                  |  |  |  |  |  |  |  |  |  |  |          |  |            |  |     |     |     |     |   |    |    |    |    |    |    |    |    |            |  |                   |     |  |      |      |      |      |      |      |      |      |      |      |     |     |     |      |  |    |     |  |      |      |      |      |      |      |      |      |      |     |     |     |    |      |  |      |

This report has been developed under a privileged and confidential assignment on behalf of the City of Ottawa. While the report has been prepared for release to City Council as requested by the City and counsel to the City, neither the City nor its' counsel waive privilege over the overall assignment.

## Figure E.4: Alltrade/CYMI Inspection Requirements

### 1.- Introduction

During the first year of service is necessary to check the functionality of the system, therefore it is required to perform an inspection along the project being the most important activities the ones listed below:

- Check and adjust Balance Weight Assemblies
- Clean and torque all the components
- Check and adjust Height and Staggers

In order to prevent future damages to the parafil during this maintenance activities CYMI/ALLTRADE applied silicone to the terminals and install heat shrink between the parafil and the terminal following the instruction from OLRT.

### 2.- Balance Weight Assemblies

In order to confirm the correct tension for the contact wire and the messenger wire the following inspection and adjustment on the Balance Weight Assemblies were performed.

#### Visual Inspection:

- Check status of the Tension Wheel
- Check status of the steel cable
- Check status of the wedge clamp
- Check status of the weights
- Check status of the brackets

#### Position of the weights

- Check position of the weights respect the hot stop

#### Re-Torque all the bolts

- Tension Wheel Bracket
- Hot Stop Bracket
- Cold Stop Bracket

Figure E.5: ALLTRADE/CYMI Check List



## BALANCE WEIGHT ASSEMBLY MAINTENANCE CHECK LIST

Project: Ottawa Light Rail Transit - OCS  
 Segment: 3  
 Position: \_\_\_\_\_ Chainage: 104+589 Track: 2

| DESCRIPTION                    |        |     | YES | NO | N/A | DATE     | COMMENTS   |
|--------------------------------|--------|-----|-----|----|-----|----------|--|
| <b>Visual Inspection</b>       |        |     |     |    |     |          |  |
| Tension Wheel in good status   |        |     | YES |    |     | 6/2/2020 | Rusty U Bolt   |
| Steel Cable in good status     |        |     | YES |    |     | 6/2/2020 |  |
| Wedge Clamp in good status     |        |     | YES |    |     | 6/2/2020 |  |
| Weights in good status         |        |     | YES |    |     | 6/2/2020 |  |
| Stop brackets in good status   |        |     | YES |    |     | 6/2/2020 | U bolt Rusty   |
| <b>Position of the Weights</b> |        |     |     |    |     |          |  |
| MW                             | T (°C) | 17c |     |    |     | 6/2/2020 |  |
| Position (mm)                  | 2250mm |     |     |    |     | 6/2/2020 | From bottom of the weight to top of hot stop bracket |
| CW                             | T (°C) | 17c |     |    |     | 6/2/2020 |  |
| Position (mm)                  | 2110mm |     |     |    |     | 6/2/2020 |  |
| <b>Re-Torque clamps</b>        |        |     |     |    |     |          |  |
| Tension Wheel Brackets         |        |     | YES |    |     | 6/2/2020 |  |
| Cold/Hot Stops Brackets        |        |     | YES |    |     | 6/2/2020 |  |

NOTES:  
 \_\_\_\_\_  
 \_\_\_\_\_  
 \_\_\_\_\_

OLRT

Name: \_\_\_\_\_  
 Signature: \_\_\_\_\_  
 Date: \_\_\_\_\_

ALLTRADE / CYMI

Name: Steve Ryznar  
 Signature: \_\_\_\_\_  
 Date: 6/2/2020

### Figure E.6: Field Measurement and Analysis

#### Balancw Weight Analysis @ ch.105+589 (Str S3-C-50)

**Reference Drawings**

Overlap Chart and Tension Lengths, drawing:  
RES-54-0-0000-DRD-1072 and 1073

Balance Weight Assembly, drawing:  
MVA-54-0-S017-DRS-5119\_0.1

**Variables**

$\alpha(\text{cu})$  1.7E-05 /°C  
Pulley ratio 3 :1

Tension length 764.2 m

Temperature 12 °C

**Design Check**

**Distance Between Low and High Temperature Stops**

Design (maximum): 5.090 m *Depnding on BWA pulley heights!*

Maximum travel required 4.677 m

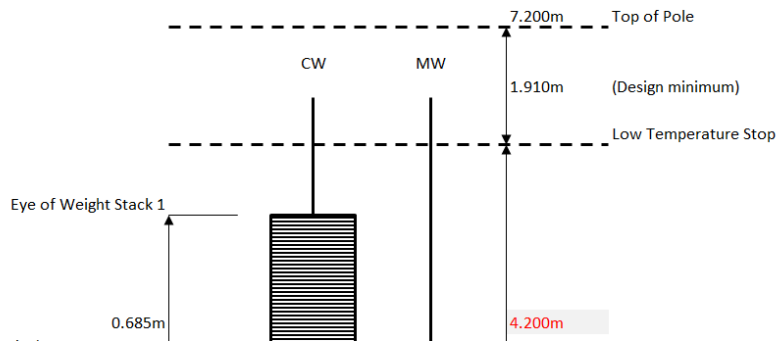
**Settings from Ground to U/side of Weight Stack:**

Design (both): 2.747 m

**Actual:**

Weight Stack 1 2.150 m *\*\*\* Set too low \*\*\**  
Weight Stack 2 2.330 m *\*\*\* Set too low \*\*\**

**Sketch of Exisitng Arrangement**



**Balance Weight Travel**

| Wire Temperature °C | Wt |
|---------------------|----|
| -40                 |    |
| -30                 |    |
| -20                 |    |
| -10                 |    |
| -9                  |    |
| -8                  |    |
| -7                  |    |
| -6                  |    |
| -5                  |    |
| -4                  |    |
| -3                  |    |
| -2                  |    |
| -1                  |    |
| 0                   |    |
| 1                   |    |
| 2                   |    |
| 3                   |    |
| 4                   |    |
| 5                   |    |
| 6                   |    |
| 7                   |    |
| 8                   |    |
| 9                   |    |
| (Design) 10         |    |
| 11                  |    |
| 12                  |    |
| 13                  |    |
| 14                  |    |
| 15                  |    |
| 16                  |    |
| 17                  |    |
| 18                  |    |
| 19                  |    |
| 20                  |    |
| 30                  |    |
| 40                  |    |
| 50                  |    |
| 60                  |    |
| 70                  |    |
| 80                  |    |

Distance between botton top of upper stop bracke

